

AddPac



AP-VP120 BcN Video Phone

Installation and Operation Guide

Release 1.00

Headquarters

AddPac Technology Co. Ltd.
2F, Jeong-Am Bldg, 769-12
Yeoksam-dong, Kangnam-gu
Seoul, 135-080, Korea
<http://www.addpac.com>
Tel: +82.2.568.3848
Fax: +82.2.568.3847

Note:

The specification and information in this document are subject to change without notice. All statements, information, and recommendations in this document are believed to be accurate but are presented without warranty of any kind, express or implied. In no event shall AddPac or its suppliers disclaim all warranties, expressed or implied, including, without limitation, lost profits or loss or damage to data arising out of the use or inability to use this manual. For detail specification, information or sales and warranty, please contact Technical Sales division of AddPac.

CONTENTS

About this guide.....	15
Chapter 1. Product Overview	17
Software Features	21
Physical Description-Front View	23
Physical Description-Rear View	25
Chapter 2. Preparing for Installation	26
Safety Recommendations	26
Maintaining Safety with Electricity	26
Site Requirements.....	27
Requirements for Network Connection	28
Package Contents	29
Chapter 3. Installing.....	32
Connecting Ethernet.....	32
Connecting PSTN.....	34
Connecting Composite RCA Video Input Port	35
Connecting Composite RCA/S-VHS Video Output	36
Connecting Composite RCA Video Input Port	37
Connecting Composite RCA/S-VHS Video Output Port	38
Connecting USB Port	39
Chapter 4. Configuring OSD.....	40
Startup.....	40
Default Screen Layout	41
Menu Composition.....	43
Using Input Mode.....	45
Phone Book Menu.....	48
Phone Book - Search by Name.....	50
Phone Book - Search by Number	54
Phone Book - Registration	60
Phone Book - Recent Call	67
Phone Book - Speed Dial.....	72
Tool Box Menu	76
Tool Box - Date&Time	78

Tool Box - Save All.....	81
Tool Box - Factory Default.....	84
Tool Box - Ring.....	87
Tool Box - Power Save.....	89
Tool Box - Information.....	91
Tool Box - Language.....	93
Tool Box - Admin Lock	95
Tool Box - User Lock	99
AV Setup Menu.....	103
AV Setup - Volume	105
AV Setup - Display	108
AV Setup - Audio Codec.....	114
AV Setup - Video Codec	117
AV Setup - Bandwidth.....	124
AV Setup - Camera	127
Network & Call Menu	131
Network & Call - Internet Setup	133
Network & Call - LAN Setup	150
Network & Call - Network Status	152
Network & Call - VoIP Setup.....	154
Network & Call - Additional Service	170
Network & Call - Multi Phone Number	178
Network & Call - Service Port Setup	180
Network & Call - Auto Upgrade.....	182
Network & Call - SSCP Setup.....	185
Application Menu	187
Application - Voice Mail.....	189
Application - Conference Room	191
Application - VoD Browser	193
Application - File Browser.....	195
Application - Application Setup.....	197
Application - Message	201
Remote Setup - Bandwidth Remote	205
Remote Setup - VCodec Remote	208
Remote Setup - Reject Remote Control.....	211
Chapter 5. Using Console Commands	213
Basic Commands for Configuring Network Settings	213
Video Mode Command List.....	216

Selecting External Audio Input Port Mode	217
Adjusting Gain Value of External Audio Input Port	217
Amplifying Microphone of External Audio Input Port	217
Selecting External Audio Output Port Mode	218
Adjusting Gain Value of External Audio Output Port	218
Adjusting Video Input Brightness	218
Adjusting Video Input Sharpness.....	218
Adjusting Video Input Saturation	219
Adjusting Horizontal Video Input Offset	219
Adjusting Vertical Video Input Offset Value	220
Adjusting the Brightness of External Video Output Port	220
Chapter 6. Appendix	221
Abbreviation and Glossary	223

FIGURES

<i>(Figure 1-1) Network Configuration of the AP-VP120 in the System Architecture</i>	<i>19</i>
<i>(Figure 1-2) AP-VP120 Front view</i>	<i>23</i>
<i>(Figure 1-3) Rear View.....</i>	<i>25</i>
<i>(Figure 2-1) Remote Control Button Features</i>	<i>30</i>
<i>(Figure 3-1) Connecting WAN.....</i>	<i>32</i>
<i>(Figure 3-2) Connecting LAN.....</i>	<i>33</i>
<i>(Figure 3-3) Connecting PSTN</i>	<i>34</i>
<i>(Figure 3-4) Connecting Video Input Port</i>	<i>35</i>
<i>(Figure 3-5) Connecting Video Output Port</i>	<i>36</i>
<i>(Figure 3-6) Connecting Video Input Port</i>	<i>37</i>
<i>(Figure 3-7) Connecting Video Output Port</i>	<i>38</i>
<i>(Figure 3-8) Connecting USB Memory Drive to the USB Port.....</i>	<i>39</i>
<i>(Figure 4-1) Startup Booting Screen.....</i>	<i>40</i>
<i>(Figure 4-2) Default Screen Layout.....</i>	<i>41</i>
<i>(Figure 4-3) Main Menu</i>	<i>43</i>
<i>(Figure 4-4) Input Mode.....</i>	<i>45</i>
<i>(Figure 4-5) Changing the Input Mode by Pressing F4 on the Remote Control.....</i>	<i>47</i>
<i>(Figure 4-6) Phone Book Menu</i>	<i>48</i>
<i>(Figure 4-7) Screen Layout of Search by Name</i>	<i>50</i>
<i>(Figure 4-8) Menu >> Phonebook.....</i>	<i>51</i>
<i>(Figure 4-9) Phonebook >> Name</i>	<i>51</i>
<i>(Figure 4-10) Search by Name.....</i>	<i>52</i>
<i>(Figure 4-11) Enter “t” from Character Set.....</i>	<i>52</i>
<i>(Figure 4-12) Select the searched name in the list and place a call to the searched name, ‘test’, by pressing Call on the remote control.....</i>	<i>53</i>
<i>(Figure 4-13) Screen Layout of Search by Number.....</i>	<i>54</i>
<i>(Figure 4-14) Menu >> Phonebook.....</i>	<i>55</i>
<i>(Figure 4-15) Phone Book >> Search By Number.....</i>	<i>55</i>
<i>(Figure 4-16) Search by Number</i>	<i>56</i>
<i>(Figure 4-17) Entering ‘1003’ by using the remote control.....</i>	<i>56</i>
<i>(Figure 4-18) Automatically finding the phone number starting with 1003.....</i>	<i>57</i>
<i>(Figure 4-19) Select Edit Mode by pressing F2 on the remote control</i>	<i>57</i>
<i>(Figure 4-20) Move to IP Address by pressing the Navigation Key on the remote control</i>	<i>58</i>
<i>(Figure 4-21) Change the IP address to “20.1.1.1”.....</i>	<i>58</i>
<i>(Figure 4-22) Press ‘OK’ on the remote control and then press ‘F3’ to save the changed setting</i>	<i>59</i>

(Figure 4-23) Registration Menu	60
(Figure 4-24) Menu >> Phone Book.....	61
(Figure 4-25) Phone Book >> Registration	61
(Figure 4-26) Registration.....	62
(Figure 4-27) Enter a name by using F4 and the number key on the remote control.....	62
(Figure 4-28) Enter a Speed Dial Number by using the keypad on the remote control.	63
(Figure 4-29) Enter a Phone Number	63
(Figure 4-30) Enter an IP address.	64
(Figure 4-31) Specify Video Codec by choosing an option.....	64
(Figure 4-32) Specify Audio Codec by choosing the option	65
(Figure 4-33) Specify Image Size by choosing the option	65
(Figure 4-34) Specify Frame Rate by choosing the option	66
(Figure 4-35) Press OK and then press F2 to save	66
(Figure 4-36) Recent Call	67
(Figure 4-37) Screen Layout of Recent Call.....	68
(Figure 4-38) Menu >> Phone Book.....	69
(Figure 4-39) Phonebook >> Recent Call	70
(Figure 4-40) Recent Call	70
(Figure 4-41) Choose the most recent phone number.....	71
(Figure 4-42) Place a call by pressing Call on the key pad.	71
(Figure 4-43) Screen Layout of Speed Dial Number	72
(Figure 4-44) Screen Layout of Speed Dial Number	73
(Figure 4-45) Menu >> Phone Book.....	74
(Figure 4-46) Phone Book >> Speed Dial Number	74
(Figure 4-47) Choose '00' for Speed Dial.....	75
(Figure 4-48) Press Call on the Keypad to place a call.....	75
(Figure 4-49) Tool Box Main Menu.....	76
(Figure 4-50) Date&Time Options	78
(Figure 4-51) Menu >> Tool Box.....	79
(Figure 4-52) Menu >> Tool Box >> Date&Time.....	79
(Figure 4-53) Date&Time	80
(Figure 4-54) Save All Main Screen.....	81
(Figure 4-55) Menu >> Tool Box >> Save All.....	82
(Figure 4-56) Press OK on the keypad to save.....	82
(Figure 4-57) 'Writing data' message is displayed	83
(Figure 4-58) 'Writing Success' message is displayed.....	83
(Figure 4-59) Factory Default Options.....	84
(Figure 4-60) Menu >> Tool Box >> Factory Default	85
(Figure 4-61) Press OK for 3 seconds	85

(Figure 4-62) All the settings are erased and automatically reset and reboot.....	86
(Figure 4-63) Ring Options	87
(Figure 4-64) Menu >> Tool Box.....	87
(Figure 4-65) Choosing a ringer sound from the given options	88
(Figure 4-66) Power Save Options.....	89
(Figure 4-67) Menu >> Tool Box >> Power Save	90
(Figure 4-68) Time Options for Power Save.....	90
(Figure 4-69) Information Menu Component	91
(Figure 4-70) Menu >> Tool Box >> Information.....	91
(Figure 4-71) Displaying the version	92
(Figure 4-72) Language Setup Options	93
(Figure 4-73) Menu >> Tool Box >> Language.....	93
(Figure 4-74) Language Setup.....	94
(Figure 4-75) Password Options	95
(Figure 4-76) Menu >> Tool Box.....	96
(Figure 4-77) Menu >> Tool Box >> Admin Lock.....	96
(Figure 4-78) Admin Lock Menu Details	97
(Figure 4-79) Use Password Options.....	97
(Figure 4-80) Change Password Options.....	98
(Figure 4-81) Admin Lock Option.....	98
(Figure 4-82) User Lock Menu Sections.....	99
(Figure 4-83) Menu >> Tool Box.....	100
(Figure 4-84) Menu >> Tool Box >> User Lock.....	100
(Figure 4-85) User Lock Menu Sections.....	101
(Figure 4-86) Use User Lock Options	101
(Figure 4-87) Change Password Options.....	102
(Figure 4-88) User Lock Option Options	102
(Figure 4-89) AV Setup Menu Section.....	103
(Figure 4-90) Volume Menu Options.....	105
(Figure 4-91) Menu >> AV Setup.....	106
(Figure 4-92) Menu >> AV Setup >> Volume	106
(Figure 4-93) Setting the Output volume to the level 5.....	107
(Figure 4-94) Display Menu Details.....	108
(Figure 4-95) Camera Setting Options.....	109
(Figure 4-96) Menu >> Av Setup.....	111
(Figure 4-97) AV Setup >> Display	111
(Figure 4-98) Display >> Camera Setting	112
(Figure 4-99) Adjusting Brightness	112
(Figure 4-100) Adjust Contrast.....	113

<i>(Figure 4-101) Screen Layout for Audio Codec Types in Preference Order.....</i>	<i>114</i>
<i>(Figure 4-102) Menu >> AV Setup.....</i>	<i>115</i>
<i>(Figure 4-103) AV Setup >> Audio Codec.....</i>	<i>115</i>
<i>(Figure 4-104) Changing the Preference Order of the Codec</i>	<i>116</i>
<i>(Figure 4-105) Video Codec Menu Details.....</i>	<i>117</i>
<i>(Figure 4-106) Menu >> AV Setup.....</i>	<i>119</i>
<i>(Figure 4-107) AV Setup >> Video Codec</i>	<i>119</i>
<i>(Figure 4-108) Specifying Frame Rate.....</i>	<i>120</i>
<i>(Figure 4-109) Selecting the option for the Video Codec of the First Menu Detail</i>	<i>120</i>
<i>(Figure 4-110) Specifying the Image Size for the First Menu Detail</i>	<i>121</i>
<i>(Figure 4-111) Specifying the Video Codec for the Second Menu Detail</i>	<i>121</i>
<i>(Figure 4-112) Selecting the option for the Image Size of the Second Menu Detail</i>	<i>122</i>
<i>(Figure 4-113) Selecting the Option for the Video Codec of the Third Menu Detail.....</i>	<i>122</i>
<i>(Figure 4-114) Selecting the Option for the Image Size of the Third Menu Detail.....</i>	<i>123</i>
<i>(Figure 4-115) Bandwidth Menu Section</i>	<i>124</i>
<i>(Figure 4-116) Menu >> AV Setup.....</i>	<i>125</i>
<i>(Figure 4-117) AV Setup >> Bandwidth.....</i>	<i>125</i>
<i>(Figure 4-118) Specifying the Detail option to 1024Kbps and then press F2 to save</i>	<i>126</i>
<i>(Figure 4-119) Screen Layout of Camera Menu Section.....</i>	<i>127</i>
<i>(Figure 4-120) Menu >> AV Setup.....</i>	<i>128</i>
<i>(Figure 4-121) AV Setup >> Camera.....</i>	<i>128</i>
<i>(Figure 4-122) Camera Menu Options</i>	<i>129</i>
<i>(Figure 4-123) Screen Layout of Camera Control Menu Detail</i>	<i>129</i>
<i>(Figure 4-124) Setting Pan/Tilt/Zoom Menu Option.....</i>	<i>130</i>
<i>(Figure 4-125) Network & Call Menu Layout.....</i>	<i>131</i>
<i>(Figure 4-126) Internet Setup Menu Detail</i>	<i>133</i>
<i>(Figure 4-127) Menu >> Network & Call >> Internet.....</i>	<i>134</i>
<i>(Figure 4-128) Select DHCP then press OK</i>	<i>134</i>
<i>(Figure 4-129) Menu >> Network & Call.....</i>	<i>135</i>
<i>(Figure 4-130) Network & Call >> Internet Setup.....</i>	<i>135</i>
<i>(Figure 4-131) Select Static IP.....</i>	<i>136</i>
<i>(Figure 4-132) Enter the IP Address of "172.17.201.232"</i>	<i>136</i>
<i>(Figure 4-133) Enter the Netmask of "255.255.0.0"</i>	<i>137</i>
<i>(Figure 4-134) Enter the Default router of '172.17.1.1'</i>	<i>137</i>
<i>(Figure 4-135) Enter the Primary DNS of '168.126.63.1'</i>	<i>138</i>
<i>(Figure 4-136) Enter the Secondary DNS of '126.63.10.5' (optional)</i>	<i>138</i>
<i>(Figure 4-137) Press OK and then the screen moves to the upper menu category</i>	<i>139</i>
<i>(Figure 4-138) Menu >> Network & Call.....</i>	<i>140</i>
<i>(Figure 4-139) Network & Call >> Internet</i>	<i>140</i>

<i>(Figure 4-140) Select PPPoE</i>	<i>141</i>
<i>(Figure 4-141) Select the option for PPPoE authentication method</i>	<i>141</i>
<i>(Figure 4-142) Enter 'Addpac' for the User Name</i>	<i>142</i>
<i>(Figure 4-143) Enter 'addpac' for the user password</i>	<i>142</i>
<i>(Figure 4-144) Press OK then the screen moves to the upper menu category.....</i>	<i>143</i>
<i>(Figure 4-145) Menu >> Network & Call.....</i>	<i>144</i>
<i>(Figure 4-146) Network & Call >> Internet Setup.....</i>	<i>144</i>
<i>(Figure 4-147) Select the option for configuring Static IPv6.....</i>	<i>145</i>
<i>(Figure 4-148) Enter IPv6 address of '2001:e78:b01:17:10::60/64'</i>	<i>145</i>
<i>(Figure 4-149) Enter the Default router address of '2001:e78:b01:17:1::1'</i>	<i>146</i>
<i>(Figure 4-150) Press OK then the screen moves to the upper menu category category.....</i>	<i>146</i>
<i>(Figure 4-151) Menu >> Network & Call.....</i>	<i>147</i>
<i>(Figure 4-152) Network & Call >> Internet Setup.....</i>	<i>147</i>
<i>(Figure 4-153) Select VLAN Setup</i>	<i>148</i>
<i>(Figure 4-154) Select the option for enabling or disabling VLAN.....</i>	<i>148</i>
<i>(Figure 4-155) Enter '10' for Vlan ID</i>	<i>149</i>
<i>(Figure 4-156) LAN Setup Menu Section</i>	<i>150</i>
<i>(Figure 4-157) Menu >> Network & Call >> LAN Setup</i>	<i>151</i>
<i>(Figure 4-158) LAN Setup Menu Options</i>	<i>151</i>
<i>(Figure 4-159) Network Status Menu Details</i>	<i>152</i>
<i>(Figure 4-160) Menu >> Network & Call >> Status</i>	<i>153</i>
<i>(Figure 4-161) Network Status Menu Details</i>	<i>153</i>
<i>(Figure 4-162) VoIP Setup Menu Details.....</i>	<i>154</i>
<i>(Figure 4-163) Menu >> Network & Call >> VoIP Setup.....</i>	<i>155</i>
<i>(Figure 4-164) VoIP Setup Menu Details.....</i>	<i>155</i>
<i>(Figure 4-165) Signaling Setup Options.....</i>	<i>156</i>
<i>(Figure 4-166) SIP Protocol Menu Options</i>	<i>157</i>
<i>(Figure 4-167) Enter SIP User Name</i>	<i>158</i>
<i>(Figure 4-168) Enter SIP User Password.....</i>	<i>158</i>
<i>(Figure 4-169) Enter the IP address of SIP Primary Server</i>	<i>159</i>
<i>(Figure 4-170) Select the option for setting 'Register E.164' to 'On' and press F2 to save and then enter Phone Number.....</i>	<i>159</i>
<i>(Figure 4-171) H.323 Protocol Menu Details</i>	<i>160</i>
<i>(Figure 4-172) Enter H.323 ID</i>	<i>161</i>
<i>(Figure 4-173) Enter the password for registering the gatekeeper</i>	<i>161</i>
<i>(Figure 4-174) Enter the IP address of the primary gatekeeper.....</i>	<i>162</i>
<i>(Figure 4-175) Enter the IP address of the secondary gatekeeper.</i>	<i>162</i>
<i>(Figure 4-176) Enter E.164 phone number</i>	<i>163</i>
<i>(Figure 4-177) Select the option for registering the gatekeeper and the press F2 to save</i>	<i>163</i>

(Figure 4-178) QoS Menu Options	164
(Figure 4-179) Menu >> Network & Call >> VoIP Setup.....	165
(Figure 4-180) Select QoS.....	165
(Figure 4-181) QoS Menu Option	166
(Figure 4-182) SIP Menu Options	167
(Figure 4-183) PSTN Prefix Menu Option	169
(Figure 4-184) Menu >> Network & Call >> Add. Service.....	170
(Figure 4-185) Additional Service Menu Details	170
(Figure 4-186) Call Forward Menu Section	171
(Figure 4-187) Forward Setup Menu Details	171
(Figure 4-188) Forward Setup Menu Details	172
(Figure 4-189) Additional Service Menu Details	173
(Figure 4-190) DoNotDisturb Menu Options	173
(Figure 4-191) Additional Service Menu Details	175
(Figure 4-192) Call Wait Menu Options.....	175
(Figure 4-193) Additional Service Menu Details	177
(Figure 4-194) Multi Phone Number Menu Option.....	178
(Figure 4-195) Menu >> Network & Call >> Multi Number	179
(Figure 4-196) Multi Phone Number Menu Option.....	179
(Figure 4-197) Service Port Setup Menu Details	180
(Figure 4-198) Menu >> Network & Call >> Service.....	181
(Figure 4-199) Service Port Setup Menu Details	181
(Figure 4-200) Auto-Upgrade Menu Details.....	182
(Figure 4-201) Menu >> Network & Call >> Auto Upgrade.....	184
(Figure 4-202) Auto Upgrade Menu.....	184
(Figure 4-203) SSCP Setup Menu Details.....	185
(Figure 4-204) Menu >> Network & Call >> SSCP Setup.....	186
(Figure 4-205) SSCP Setup Menu Details.....	186
(Figure 4-206) Application Menu	187
(Figure 4-207) Screen Layout for Voice Mail Menu Sections	189
(Figure 4-208) Menu >> Applications>> Voice Mail.....	190
(Figure 4-209) Voice Mail Menu Sections.....	190
(Figure 4-210) Screen Layout of Conference Room	191
(Figure 4-211) Menu >> Applications >> Conference Room	192
(Figure 4-212) Conference Room Menu Details	192
(Figure 4-213) Screen Layout of VoD Browser Menu Section.....	193
(Figure 4-214) Menu >> Application >> VoD Browser.....	194
(Figure 4-215) Connecting to VoD Server	194
(Figure 4-216) Screen Layout of File Browser Menu Section	195

(Figure 4-217) Menu >> Applications>> App. Setup	196
(Figure 4-218) Screen Layout of File Browser Menu Section	196
(Figure 4-219) Screen Layout of Application Setup Menu Section	197
(Figure 4-220) Menu >> Applications>> App. Setup	198
(Figure 4-221) Application Setup Menu.....	198
(Figure 4-222) Menu >> Applications>> App. Setup >> VoD Browser.....	199
(Figure 4-223) Specifying VoD Server Address.....	199
(Figure 4-224) Menu >> Applications >> Application Settings >> Document Share	200
(Figure 4-225) Document Share Menu Details.....	200
(Figure 4-226) Screen Layout of Message Menu Details.....	201
(Figure 4-227) Menu >> Applications>> SMS.....	202
(Figure 4-228) Message Menu Details	202
(Figure 4-229) Write Message.....	203
(Figure 4-230) Send the message.....	203
(Figure 4-231) Screen Layout of Remote Setup Menu Category.....	204
(Figure 4-232) Screen Layout of Bandwidth Remote Menu Details	205
(Figure 4-233) Menu >> Remote Setup.....	206
(Figure 4-234) Remote Setup >>Bandwidth.....	206
(Figure 4-235) Bandwidth Remote Menu Details.....	207
(Figure 4-236) Video Codec Remote Menu Details	208
(Figure 4-237) Menu >> Remote Setup.....	209
(Figure 4-238) Remote Setup >> Video Codec.....	209
(Figure 4-239) Selecting the Image Size of QVGA at the Frame Rate of 30fps	210
(Figure 4-240) Menu >> Remote Setup.....	211
(Figure 4-241) Remote Setup >> Reject Remote	211
(Figure 4-242) Remote Setup >> Reject Remote	212
(Figure 4-243) Select the option to permit or reject remote control.....	212
(Figure 6-1) 100Base-TX RJ-45 Connector	222

TABLES

<i>[Table 1-1] Hardware Specifications.....</i>	<i>20</i>
<i>[Table 1-2] Software Specifications</i>	<i>21</i>
<i>[Table 1-3] Description of the Button Features</i>	<i>23</i>
<i>[Table 1-4] Description of the Connectors on the Rear Side</i>	<i>25</i>
<i>[Table 2-1] AP-VP120 Product Package</i>	<i>29</i>
<i>[Table 2-2] Remote Control Button Features.....</i>	<i>30</i>
<i>[Table 3-1] Description of USB Interface Usage.....</i>	<i>39</i>
<i>[Table 4-1] Description of Layout Display of Basic Screen</i>	<i>41</i>
<i>[Table 4-2] Description of Menu Composition.....</i>	<i>44</i>
<i>[Table 4-3] Description of Input Mode</i>	<i>46</i>
<i>[Table 4-4] Components of Phone Book Menu.....</i>	<i>49</i>
<i>[Table 4-5] Description of Recent Calls.....</i>	<i>68</i>
<i>[Table 4-7] Tool Box Menu Components.....</i>	<i>77</i>
<i>[Table 4-8] Description of Date&Time Options.....</i>	<i>80</i>
<i>[Table 4-9] Description of Information Details.....</i>	<i>92</i>
<i>[Table 4-10] Description of Language Setup Options</i>	<i>94</i>
<i>[Table 4-11] Description of Password Options.....</i>	<i>95</i>
<i>[Table 4-12] Description of User Lock Menu Sections</i>	<i>99</i>
<i>[Table 4-13] Description of Menu Composition of AV Setup.....</i>	<i>104</i>
<i>[Table 4-14] Description of Volume Menu Options</i>	<i>107</i>
<i>[Table 4-15] Description of Display Menu Details</i>	<i>108</i>
<i>[Table 4-16] Description of Display Menu Options</i>	<i>110</i>
<i>[Table 4-17] Description of Video Codec Menu Details</i>	<i>118</i>
<i>[Table 4-18] Description of Bandwidth Menu Details</i>	<i>124</i>
<i>[Table 4-19] Menu Composition of Network & Call</i>	<i>132</i>
<i>[Table 4-20] Description of Internet Setup Menu Details.....</i>	<i>133</i>
<i>[Table 4-21] Description of LAN Setup Menu Details</i>	<i>150</i>
<i>[Table 4-22] Description of Network Status Menu Details.....</i>	<i>152</i>
<i>[Table 4-23] Description of SIP Protocol Menu Options.....</i>	<i>157</i>
<i>[Table 4-24] Description of H.323 Protocol Menu Details.....</i>	<i>160</i>
<i>[Table 4-25] Description of QoS Menu Options.....</i>	<i>164</i>
<i>[Table 4-26] Description of SIP Menu Options</i>	<i>168</i>
<i>[Table 4-27] Description of PSTN Prefix Menu Option</i>	<i>169</i>
<i>[Table 4-28] Description of Call Forward Menu Options</i>	<i>172</i>
<i>[Table 4-29] Description of DND Menu Options</i>	<i>174</i>
<i>[Table 4-30] Description of Call Wait Setup Menu Options.....</i>	<i>176</i>

[Table 4-31] Description of Call Wait Setup Menu Options	177
[Table 4-32] Description of Multi Phone Number Menu Option	178
[Table 4-33] Description of Configuration Auto Upgrade Menu Details	183
[Table 4-34] Description of SSCP Menu Details	185
[Table 4-35] Composition of Application Menu Categories	188
[Table 4-36] Description of Voice Mail Menu Section	189
[Table 4-37] Description of Message Menu Details.....	201
[Table 4-38] Description for Composition of Remote Setup Menu Sections	204
[Table 5-1] Video Mode Command LIST.....	216
[Table 6-1] Console Port Pin-Out.....	221
[Table 6-2] Signals and Pin-Out of Serial Ethernet Cable	222

About this guide

This section discusses document objectives, document organization, targeted audience.

Document Objectives

The purpose of this document is to assist the users install and operate the AddPac AP-VP120 video phone easily. This guide describes the initial site preparation, hardware installation and troubleshooting of the AddPac AP-VP120 video phone. Also included is information describing the hardware components, power supplies and cables.

Audience

This guide is designed for the video telephony technician who is responsible for installing the AddPac AP-VP120. The technician should be familiar with electronic circuitry and wiring practices and have experience as an electronic or electromechanical technician. It is assumed that the system technician has experience with the installation of networking equipment. If you have used a video phone before, refer to helpful chapters. If the technician is familiar with video phone product, it is recommended to read the entire document thoroughly before handling AP-VP120. If the technician is familiar with video phone product, the technician may read this guide selectively.

Document Organization

This table describes the contents of each chapter in this document.

Table 1 Document Organization

Chapter	Title	Description
Chapter 1	Introduction	Overview of the features of the AP-VP120, and describes its hardware and software specification
Chapter 2	Preparing for Installation	Describes the environment required for the AP-VP120 installation as well as safety recommendations and preparatory information on AP-VP120 installation.
Chapter 3	Installing	Describes how to connect cables and acoustic or video devices to AP-VP120 and basic information on installation
Chapter 4	Configuring OSD Settings	Describes the configuration setting for OSD operation. OSD stands for 'On Screen Design', the screen for configuration settings of the video phone by using the remote control.
Chapter 5	Operating	Describes how to use various supplementary features of the AP-VP120 by using the remote control and keypad.
Chapter 6	Using Touch Screen	Describes the basic touch screen layout how to use the touch screen
Chapter 7	Console Commands	Explains the commands used for configuring the console port
Chapter 8	Appendix	Provides specifications and describes the cables used for the interfaces of the AP-VP120

Chapter 1. Product Overview

AP-VP120 is an IP video phone that allows you to make high quality and high resolution video communications by using the Internet. This product supports a video conference, point-to-point video communication, VoD, IPTV, network surveillance, and aid to communication access for the disabled optimally through the latest audio/video codecs and a variety of AV I/O interfaces. The criteria of choosing a video phone are high quality audio and video.

AP-VP120 is a new IP video phone where Internet voice communications are combined with Internet video communications. This product provides advanced features and services such as video codecs (e.g. H.263, MPEG-4, H.264, and JPEG), RCA A/V I/O interfaces, QoS, and public IP sharing as well as multiple VoIP signaling protocols such as SIP and H.323.

AP-VP120 is a high-performance multi-functional IP video phone where the state-of-the-art video processing technology is added to the voice processing technologies developed by AddPac in the VoIP field. AP-VP120 has better video features since it ensures high definition video due to a high-quality 4.3" LCD and you can enjoy a large screen connected to the external monitor. Since AP-VP120 supports networks of 64 Kbps to several Mbps, it is available at any Internet-enabled place. Above all, AP-VP120 ensures the best video quality due to the 'rate control' function that ensures the best video quality and frame rate at a limited bandwidth and the high-end error resilience technology for troubleshooting various packet failures on the Internet.

The high-performance RISC CPU and DSP of AP-VP120 are all programmable; thus, the features of AP-VP120 can continue to be improved, changed, or added. If you download an added or changed feature from the home page directly or set an automatic upgrade option whenever feature addition or change is done, you can use the latest feature without further operations.

The supplementary services of AP-VP120 as well as its various features would meet your needs. AP-VP120 provides various services that allow you to use a phone easily, which include a phone book, a latest call log, and Caller ID (CID). Also, this product as well as AddPac IP-PBX solutions supports a wide variety of supplementary services such as voice and video mail services in addition to calling services such as a call transfer. The advantage of AP-VP120 is to support the unique supplementary services of AddPac. Broadcasting, instant messaging, IPTV, and VoD service are the main supplementary services of AddPac. If AP-VP120 is connected to the AddPac Technology's IP broadcasting server equipment, AP-VP120 can be used as IP voice and video broadcasting terminal as well as Video Phone terminal. This product inter-works with the instant messaging server, IPTV server, and enterprise VoD solution of AddPac to provide advanced services.

AP-VP120 is integrated network equipment that enables routing, NAT/PAT, DHCP Server/Relay, public IP sharing, and QoS. Advanced QoS and security as well as various network services should be supported to adapt to a variety of network environments such as high-speed individual subscriber networks (e.g. xDSL, cable networks, and FTTH), Metro Ethernet, Metro ATM, leased lines, and flexible IPs. In this regard, AP-VP120 has two 10/100 Mbps Fast Ethernet ports to support a variety of network and security services such as high-performance LAN-to-LAN routing, bridge, and NAT/PAT. In addition, AP-VP120 supports H.323 and SIP VoIP signaling protocols concurrently. The technologies of AP-VP120 are differentiated from those of the traditional equipments in that one AP-VP120 supports two VoIP signaling protocols concurrently; thus, even if AP-VP120 moves to another Internet Telephony Service Provider (ITSP) whose VoIP signaling protocol is different, AP-VP120 can easily adapt to a new environment without change. AP-VP120 is a reliable solution that ensures good technologies.

The rear panel of AP-VP120 has the USB master mode interface. AP-VP120 supports standard USB flash memory, a USB hard disk, a USB keyboard, and a USB mouse. Several USB devices can be connected by using a USB hub. A separate power supply device should be used for a USB device that requires much power consumption since limited power is supplied to the USB device. If USB memory is used, AP-VP120 enables a file browser, and decodes MP3, JPEG, PMA (video stream format of AddPac) files. Video data that require much memory can be saved in external USB memory.

AP-VP120 supports reliable service security as well as network access security. This product allows you to check the target phone number before answering a phone through Caller ID Detection (CID) and to disable the audio or video functions easily by using the wireless remote control. If you select the 'Privacy' menu, you can disable either or both of voice and video in advance.

The performance and reliability of AddPac VoIP, Video and Multimedia equipments have been recognized in global markets as well as the Korean market. AP-VP120, which is a collection of experiences and know-how accumulated in the enterprise and service provider markets, would be a solution that meets the needs of customers that ask for next-generation communications.

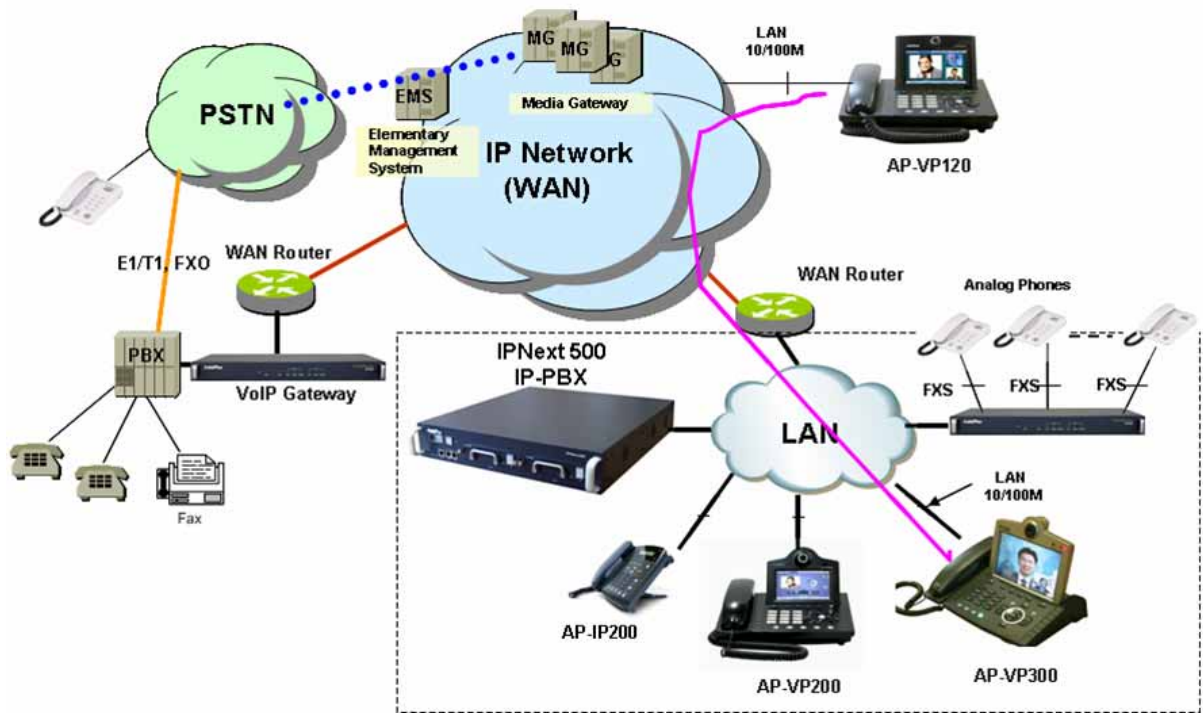

(Figure 1-1) Network Configuration of the AP-VP120 in the System Architecture

Hardware Features

[Table 1-1] Hardware Specifications

CPU	High Performance RISC CPU Architecture	
	Programmable High Performance DSP	
Memory	Flash Memory	8Mbyte
	Main Memory	64Mbyte
	Boot Memory	512Kbyte Flash Memory
Network Interface Module	Fixed LAN0 Port	One(1) 10/100Mbps Fast Ethernet
	Fixed LAN1 Port	One(1) 10/100Mbps Fast Ethernet
	Console Port (Optional)	One(1) RS-232C Interface for Controlling
Video Interface	Input	One(1)-Composite(RCA) Connector for External Camera
	Output	One(1)-Composite(RCA) Connector for TV or VCR
		One(1) S-Video Connector for TV or VCR
Audio Interface	Input	One(1)-3.5mm Stereo-In Connector for Audio In
	Output	One(1)-3.5mm Stereo-Out Connector external Speaker
User Interface	USB 1.1 Master	USB Flash Memory, USB HDD, USB Keyboard, USB Mouse etc
Power & Operation Environments	Power Requirement	External Power VAC 110~220 VAC, 50/60Hz
	Operating Temperature	0°C to + 45°C (32° to 112°F)
	Storage Temperature	-40°C ~ +85°C (-40° ~ +185°F)
	Relative Humidity	5% ~ 95% (Non-condensing)
Dimensions	W x D x H (mm)	230 x 215 x 185
	Weight (Kg)	1.2Kg

Software Features

[Table 1-2] Software Specifications

LAN Protocol	Static and IEEE 802.1Q VLAN Routing	
WAN Protocol	Point-to-Point Protocol (PPPoE for ADSL), DHCP, Static IP, etc.	
Video Service	Codec	MPEG4, H.263, H.264, JPEG()
	Resolution	QCIF(176x144), CIF(352x288), QVGA(320x240)
	Frame Rate	Up to 30fps with Wide QVGA-Resolution
	Operating Bandwidth	64Kbps ~ Several Mbps
Audio Service & Signaling Protocol	Voice & Audio Codec - MP3 for High Quality Stereo Audio : 22.5Khz~44.1Khz Sampling - AAC* - G.711, G.723.1, G.726, G.729, etc	
	H.323, SIP Dual Stack Support	
	ITU-T H.323 v3 VoIP Protocol with ITU-T H.235 Security Feature	
	Voice Processing Features Supports - VAD, DRMF, CNG, G.168	
	ITU-T H.323 Gateway, Gatekeeper Support	
	Enhanced QoS Management Features for Voice Traffics	
Network Management	Standard SNMP Agent (MIB v2) Support	
	Traffic Queuing and Frame-Relay Flow Control	
	Remote Management using Console, Rlogin, Telnet	
	Web based Managements using HTTP Server Interface	
Security Functions	Standard & Extended IP Access List	
	Access Control and Data Protections	
	Enable/Disable for Specific Protocols	
	Multi-Level User Account Management	
	Auto-disconnect for Telnet/Console Sessions	
	PPP User Authentication Supports → Password Authentication Protocol(PAP) → Challenge Handshake Authentication Protocol (CHAP)	

Operation & Management	System Performance Analysis for Process, CPU, Connection I/F
	Configuration Backup & Restore for APOS Managements
	Debugging, System Auditing, and Diagnostics Support
	System Booting and Auto-rebooting with Watchdog Feature
	System Managements with Data Logging
	IP Traffic Statistics with Accounting
Other Scalability Features	DHCP Server & Relay Functions
	Network Address Translation (NAT) Function
	Port Address Translation (PAT) Function
	Transparent Bridging (IEEE Standard) Function → Spanning Tree Bridging Protocol Support → Remote Bridging Support → Concurrent Routing and Bridging Support
	Cisco Style Command Line Interface(CLI)
	Network time Protocol(NTP) Support

Physical Description-Front View

The hard case of the AP-VP120 is a standalone type of network product, which is made of high-strength ABS. The main key buttons are placed on the front panel of this product, you can operate just about any and all system operations by using the key buttons. The rear panel consists of a variety of audio and video interfaces including the WAN/LAN interfaces.

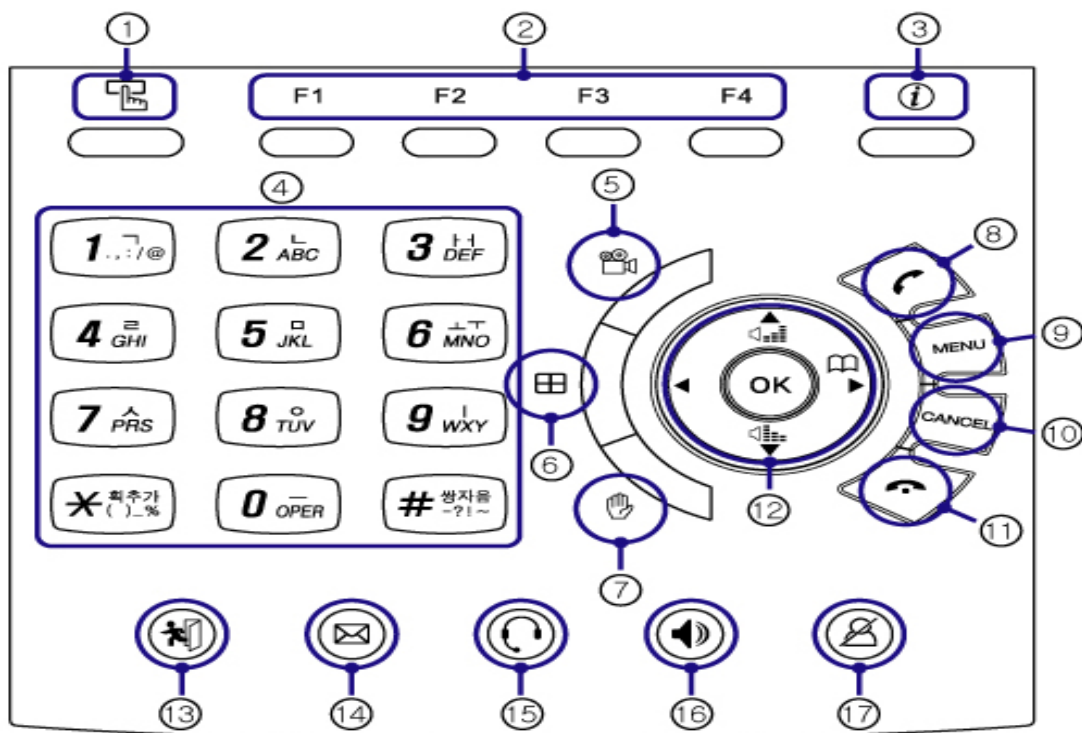

(Figure 1-2) AP-VP120 Front view

This table shows and describes the button features on the front side of your AP-VP120.

[Table 1-3] Description of the Button Features

No.	Name	Description
(1)	SpeedDial	Brings out the Speed Dial menu.
(2)	F1~F4	Engages the function keys assigned to each of the soft key tab displayed on the bottom of the LCD screen when the menus such as PhoneBook and SpeedDial are used.

(3)	INFO	Chooses the option for displaying information such as line/call status, phone number, date, time and soft key tabs on the top and bottom of the screen
(4)	Keypad	Functions like a tradition telephone key pad. Also used for configuring the settings of OSD menu by using the remote control.
(5)	Camera	Turns on/off the camera
(6)	View	Changes to conversation, remote and local view during phone conversation
(7)	Hook Flash	Simulates quickly hanging up then picking up again (a quick off-hook/on-hook/off-hook cycle. This action can signal the telephone exchange to do something such as dialing the second number and greet the second party. A common use of hook flash is to switch to another incoming call with the call waiting service. Another use is to connect the speaker phone or headset
(8)	Call	Brings out the recent call list Also makes a call after dialing the displayed number
(9)	Menu	Brings out the OSD main menu
(10)	Cancel	Cancel the last selection and moves one level up from the present level in the OSD menu
(11)	END	Terminates the present call
(12)	Navigation & OK	Scrolls through text and selects confirms the selection that are displayed on the OSD menu and sets volume
(13)	Abesnce	Takes an incoming call when the phone user is away from the phone
(14)	Voice Mail	Listens to the voice mail
(15)	HDP Call	Activates a headset
(16)	SPK Call	Activates the built-in speaker phone
(17)	Privacy	Blocks the view on my side, so the other party can not see you while you are placing a call

Physical Description-Rear View

The rear panel of AP-VP120 has two 10/100Mbps Fast Ethernet interfaces for WAN/LAN access, the PSTN port for accommodating the regular Central Office line, video I/O port and audio I/O port, which connect to video and acoustic devices, as well as the RS-232C port, which allows you to access the console for device management and camera control.

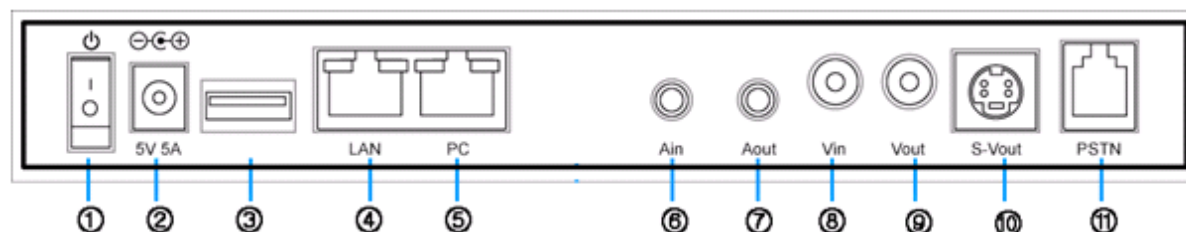

(Figure 1-3) Rear View

[Table 1-4] Description of the Connectors on the Rear Side

No.	Name	Description
(1)	SW	Power Switch
(2)	DC 5V 5A	DC 5V 5A adapter port
(3)	USB	Universal Serial Bus connector in the standard of 1.1 for transmitting 12Mbps at maximum and connecting to USB memory devices.
(4)	LAN	Fast Ethernet port (10/100Mbps for connecting to the uplink (RJ45))
(5)	PC	Fast Ethernet port (10/100Mbps for connecting to the downlink (RJ45))
(6)	AIN	Audio Input port for connecting an external device such as microphone. Use the remote control to configure MIC and Line In
(7)	AOUT	Audio Output port for connecting an external device such as headphone or speaker
(8)	VIN	RCA composite video input port for connecting video input devices such as camera or DVR player.
(9)	VOUT	RCA composite video output port for connecting analog video output devices such as TV
(10)	S-Video	S-VIDEO video output port for connecting video output devices such as high video quality TV, projector and PDP.
(11)	PSTN	1-port PSTN Backup port for accommodating PSTM Central Office line.

Chapter 2. Preparing for Installation

Safety Recommendations

The following safety guidelines are recommended when working with the equipment:

- Keep the area around the AP-VP120 as free from dust as is practical before and after installation..
- When you need to open the cover of the AP-VP120, please place the equipment on a flat and safe place.
- When you work on the equipment, please do not wear any loose clothes. When you wear a tie or scarf, please be careful not to slip down and roll up the sleeves because if you don't, you can entangled to the equipment
- Avoid any actions that may effect the equipment or the operator.

Maintaining Safety with Electricity

There are two main sources of electrical problems with the AP-VP120: the power supply and static electricity.

This section describes safety recommendations for each case.

- Work in a place where you can shut down the power immediately in case of an accident due to electricity.
- When you install or uncover the equipment, please turn off the power.
- Avoid operating the equipment alone at a potentially dangerous environment.
- Do not assume the power is switched off, but always confirm the power status.
- Be extremely cautious when operating in a humid environment or with an uncovered power extension cable.
- The main chip sets are the components with high precision. When they are mishandles, they can be damaged by electric static

Site Requirements

The AP-VP120 is ready for use where electronic products are used. However, a location with the following conditions is recommended for the maximum performance:

- A level and well ventilated location is recommended.
- Secure the equipment safely where intended to install.
- Avoid placing objects on top of the equipment.
- Install the equipment in a cool location avoiding direct sunlight.
- Maintain distance from flammable, chemical, or magnetic objects

Requirements for Network Connection

This procedure is to follow EIA standards and other EMI regulations when you install the Gateway

The following section describes the Ethernet Cable, and the Console Cable which can be connected to the AP-VP120.

Required Tools and Equipment

Some cables and equipment are not included and your need to purchase them separately. Please prepare the following tools and equipment

LAN Cable & Console Port Cable

- RJ-45 to RJ-45
- RS232C console cable with RJ-45 connector (included in the box)

Ethernet Port

The AP-VP120 has two RJ45 type of 10/100 BaseTX Ethernet ports on the rear side and LED for indicating the status of the port on the front. These ports are physically connected and using the direct cable you can connect to LAN0/ LAN1. Please use the standard cable and connector to access to LAN. You may refer to the cable details of Appendix in this guide

Console Port (Optional)

AP-VP120 has one RJ-45 type3 of RS-232C Female DCE Connector Interface. Through this port, you can perform the initial setup, monitoring and debugging the system. The cable and connector must be used. You may refer to the pin connection for RS-232 console cable of appendix in this guide.

Package Contents

Completely unpack all of the contents from the box and inspect each item for damage and ensure that you have all of the components listed below:

[Table 2-1] AP-VP120 Product Package

No	Name	Contents	Quantity
1	AP-VP120 Main Body		1
2	Remote Control (Optional)		1
3	LAN Cable (RJ45 to RJ45)		1
4	External Power Adapter and Power Cable (220V Power Cord)		1

Remote Control Button Features

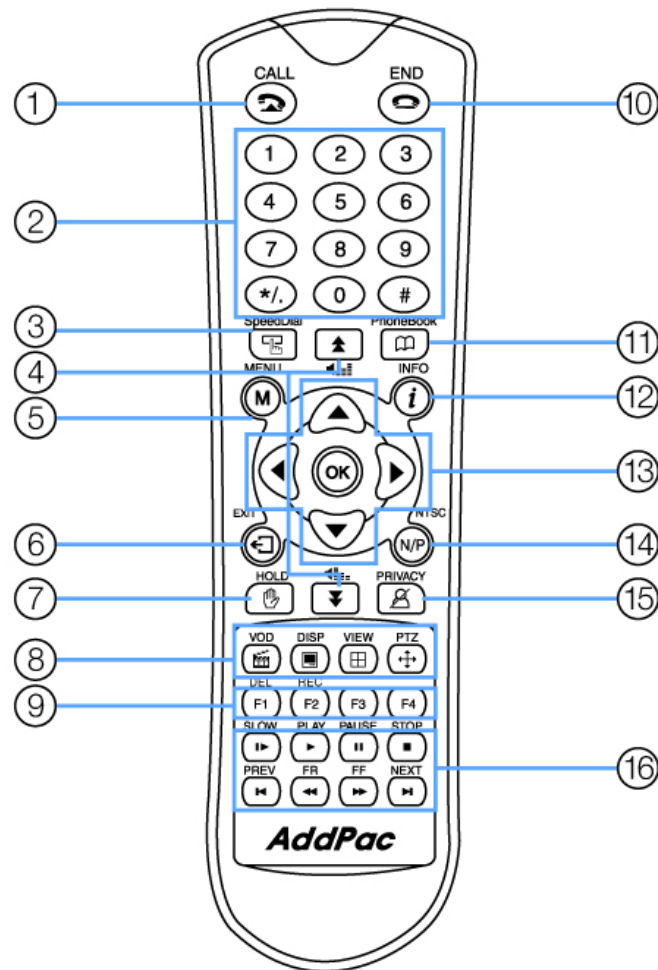

(Figure 2-1) Remote Control Button Features

[Table 2-2] Remote Control Button Features

No.	Name	Features
(1)	Call	Brings out the recent call list Also makes a call after dialing the displayed number
(2)	Alphanumeric Keypad	Functions like a tradition telephone key pad. Another use is configuring the settings of OSD menu
(3)	SpeedDial	Brings out the Speed Dial menu
(4)	VOL+/-	Increases or decreases ringer loudness, phone conversation volume or audio port volume
(5)	Menu	Brings out the main OSD menu

(6)	EXIT	Moves one level up from the present level in the OSD menu
(7)	HOLD	Blocks the view on my side, so the other party can not see you while you are placing a call . While a call is placed on hold, the other party's video view and voice is blocked (the button works different from the keypad on the phone).
(8)	VOD/DISP /VIEW/PTZ	VOD : Functions VoD Browser DISP : Not in use VIEW: Changes the screen view for convention/ remote/ local PTZ : Brings out the Pan/ Tilt menu for controlling the external camera
(9)	F1~F4	Soft keys that can change the function of each OSD menu for the external camera (applied to only EVI-D70 and 100) of the other party's AddPac video devices in the remote location such as the AddPac Video Conferencing Servers (AP-VC1000, AP-VC2000) or Video Gateway. Press the PTZ button (in section10 first and then use the following soft keys to control the following functions of the camera in the remote or local site: F1 : Power on/off the external cameras in the remote location F2 : Enable direction reverse for controlling the camera or save the setting value of OSD in the remote location F3 : Display the input image of the camera on bilateral symmetry basis in the remote location F4 : Enable backlight of the camera in the remote location
(10)	END	Activate the power on suspend mode by giving the button a long press Release from the power on suspend mode by touching the button (a short press).
(11)	PhoneBook	Brings out the Phone Book menu
(12)	INFO	Chooses the option for displaying information such as line/call status, phone number, date, time and soft key tabs on the top and bottom of the LCD screen
(13)	Navigation Key, OK	Scrolls through text and selects confirms the selection that are displayed on the OSD menu or controls the external camera movement by using Pan/Tilt menu .(Pan/Tilt menu is opened)
(14)	N/P	Not in use
(15)	Privacy	Blocks the view on my side, so the other party can not see you while you are placing a call
(16)	SLOW/PLAY/ PAUSE/STOP/ PREV/FR/FF/ NEXT	Functions VoD Browser. File Browser. This button feature can be used only when your AP-VP120 is connected with AddPac Video on Demand server such as AP-VD1000 in the remote location

Chapter 3. Installing

Connecting Ethernet

- A connection to Internet is made through the LAN interface of the WAN accessing equipment such as router, ADSL or cable modem. The LAN is connected by RJ45 standard of the UTP cable.
- Sometimes the cross-over cable is used to connect to the router, xDSL or cable modem
- Use Direct-Through cable for connecting to the hub

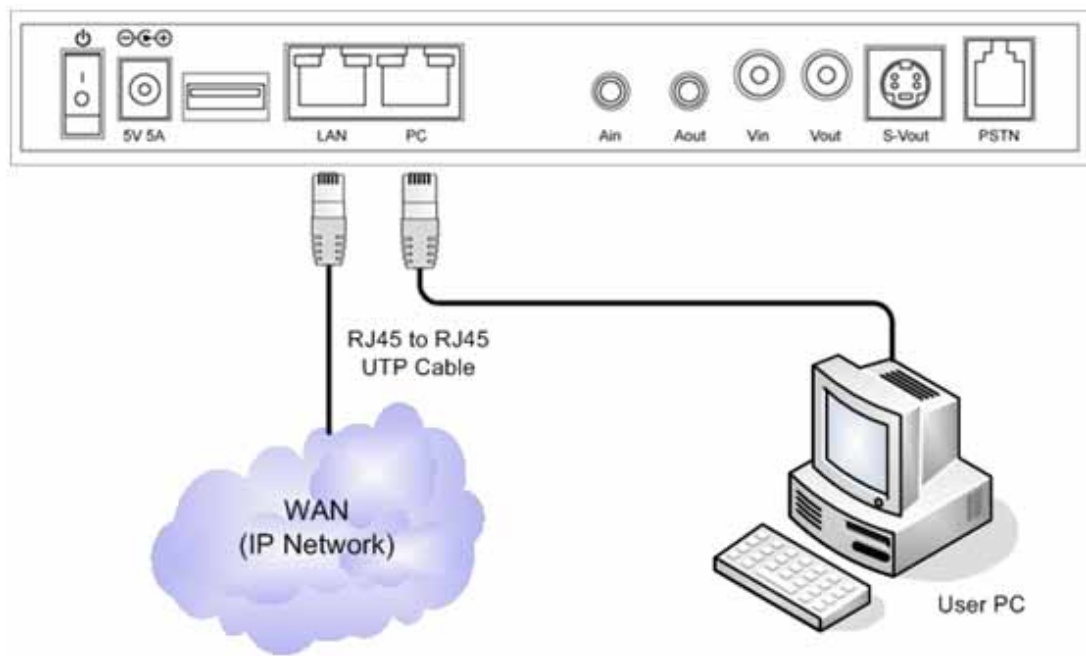

(Figure 3-1) Connecting WAN

- When LAN1 is set to IP-Share mode, it is connected to PC on Direct-Through cable.
- Use Direct-Through cable to connect to PC directly
- User Cross-Over cable to connect to the hub directly

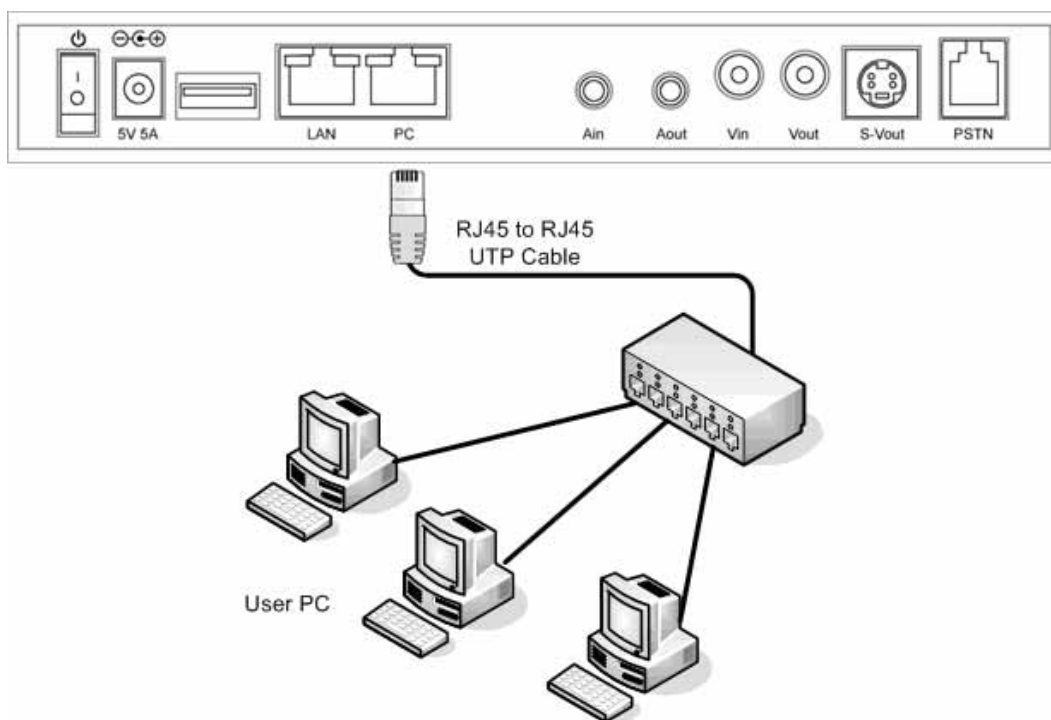

(Figure 3-2) Connecting LAN

Connecting PSTN (Optional)

This PSTN port is used for connecting PSTN Central Office line in case of a network failure. The user may connect the PSTN cable to the PSTN port in order to implement PSTN backup. As shown in the figure below, connect the PSTN cable:

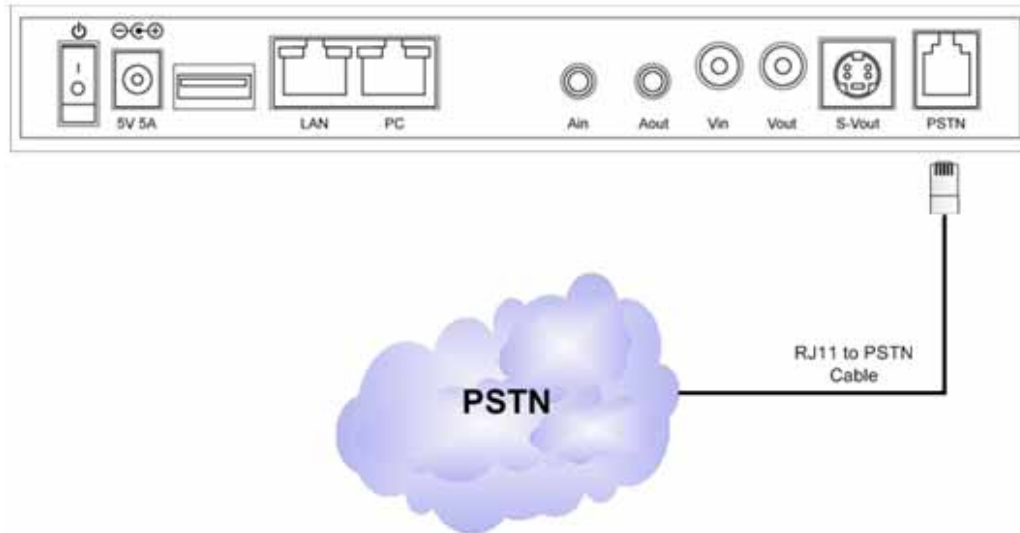

(Figure 3-3) Connecting PSTN

Connecting Composite RCA Video Input Port

The video input port is basically used to connect to EVI-D70 video camera, but it can also be used for connecting to other video devices such as DVD player. This video input port has S-Video, composite RCA types. So any video device with the composite RCA video output port can be connected to AP-VP120. The following figure shows a connection with the video camera by using the composite RCA video cable.

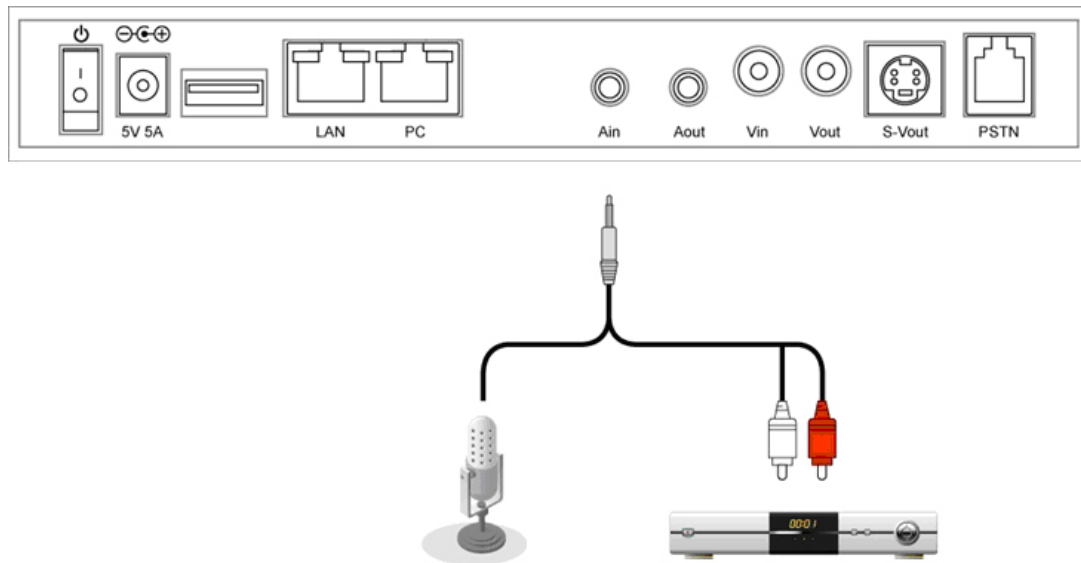

(Figure 3-4) Connecting Video Input Port

Connecting Composite RCA/S-VHS Video Output

The available video output ports are categorized by Composite RCA, S-VHS and Component. The AP-VP120 is capable of displaying the video image to these 3 different types of interface simultaneously. All you have to do is just find and connect the matching type of cable. The following figure shows connecting RCA, S-VHS and Component cables to TV.

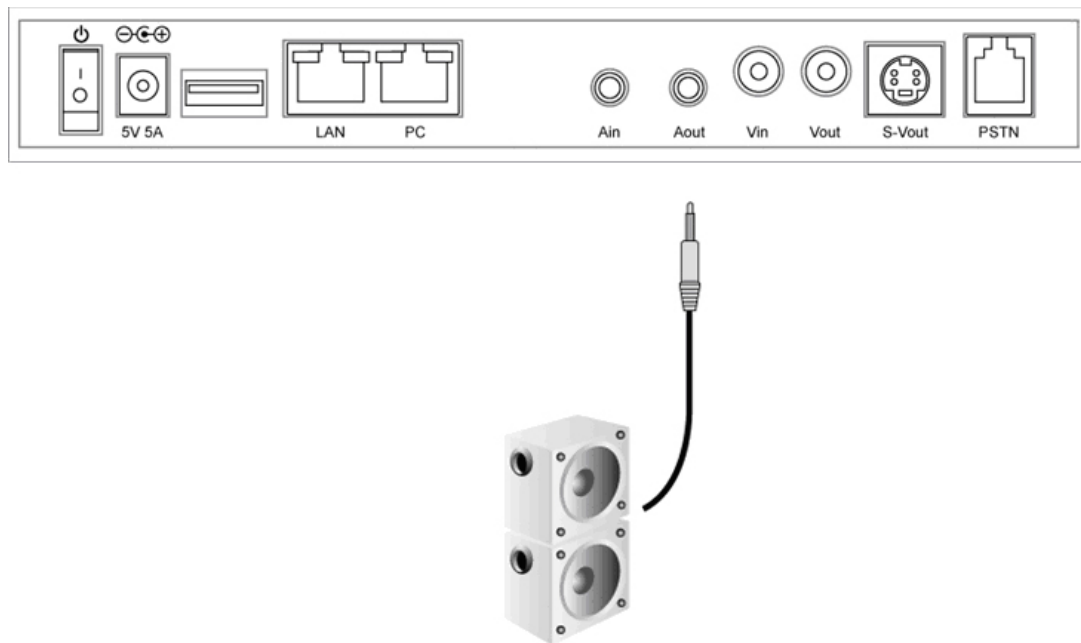

(Figure 3-5) Connecting Video Output Port

Connecting Composite RCA Video Input Port

The video input port is basically used to connect to EVI-D70 video camera, but it can also be used for connecting to other video devices such as DVD player. This video input port has S-Video, composite RCA types. So any video device with the composite RCA video output port can be connected to AP-VP120. The following figure shows a connection with the video camera by using the composite RCA video cable.

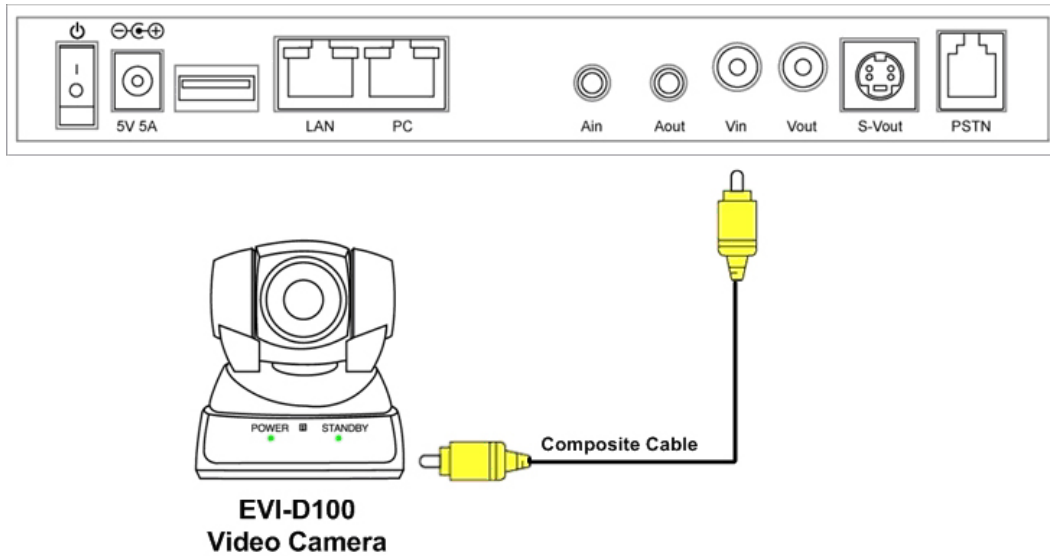

(Figure 3-6) Connecting Video Input Port

Connecting Composite RCA/S-VHS Video Output Port

The available video output ports are categorized by Composite RCA, S-VHS and Component. The AP-VP120 is capable of displaying the video image to these 3 different types of interface simultaneously. All you have to do is just find and connect the matching type of cable. The following figure shows connecting RCA, S-VHS and Component cables to TV.

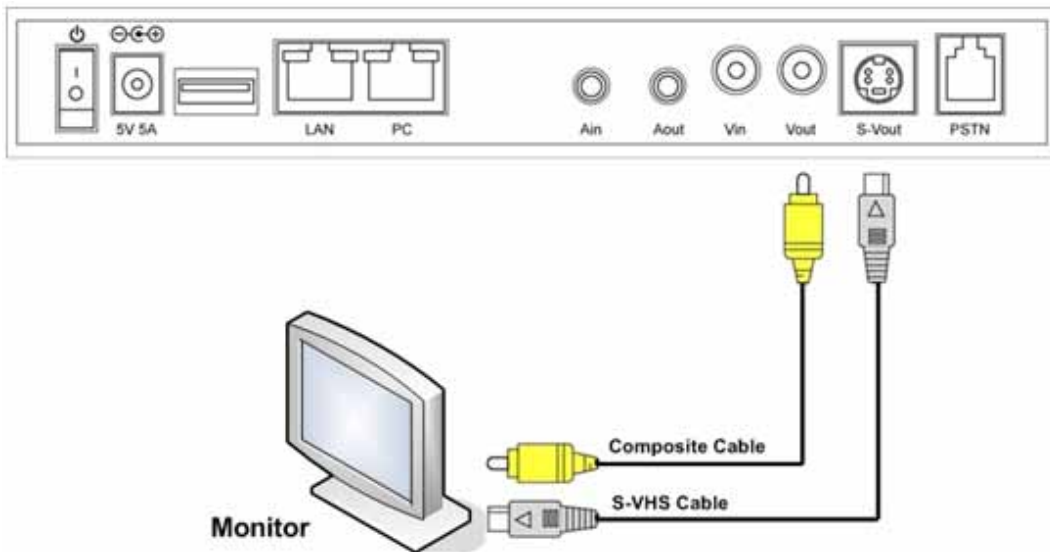

(Figure 3-7) Connecting Video Output Port

Connecting USB Port

The USB port of AP-VP120 is based on the standard of 1.1, which can transmit data at 12Mbps. The user can connect to the USB memory drive and Table 3-1 describes its usage. However, a standalone type of hard disk drive may not operate when enough power is not supplied.

[Table 3-1] Description of USB Interface Usage

No	Features	Description	Comments
1	Voice Recording	Saves telephone conversation into the USB memory	voice
2	Video Recording	Saves telephone conversation into the USB memory	video + voice
3	Viewing Image	Views JPEG images saved in the USB memory	JPEG
4	Saving Image	Saves still motion of the video image in to the USB memory while talking over the phone	JPEG
5	Security Lock	Functions as a security lock or encryption key for telephone conversation	

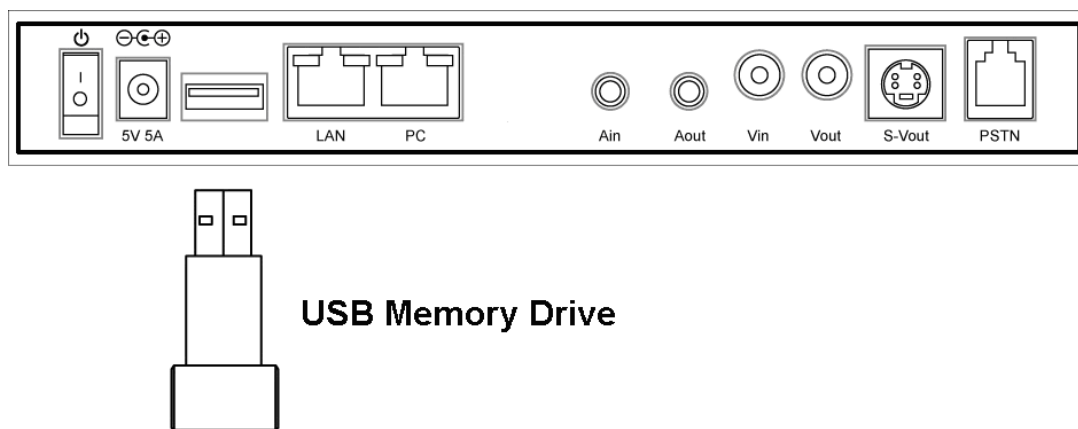

(Figure 3-8) Connecting USB Memory Drive to the USB Port

Chapter 4. Configuring OSD

Startup

The following figure shows the start of booting screen of the AP-VP120 when the power is turned on.

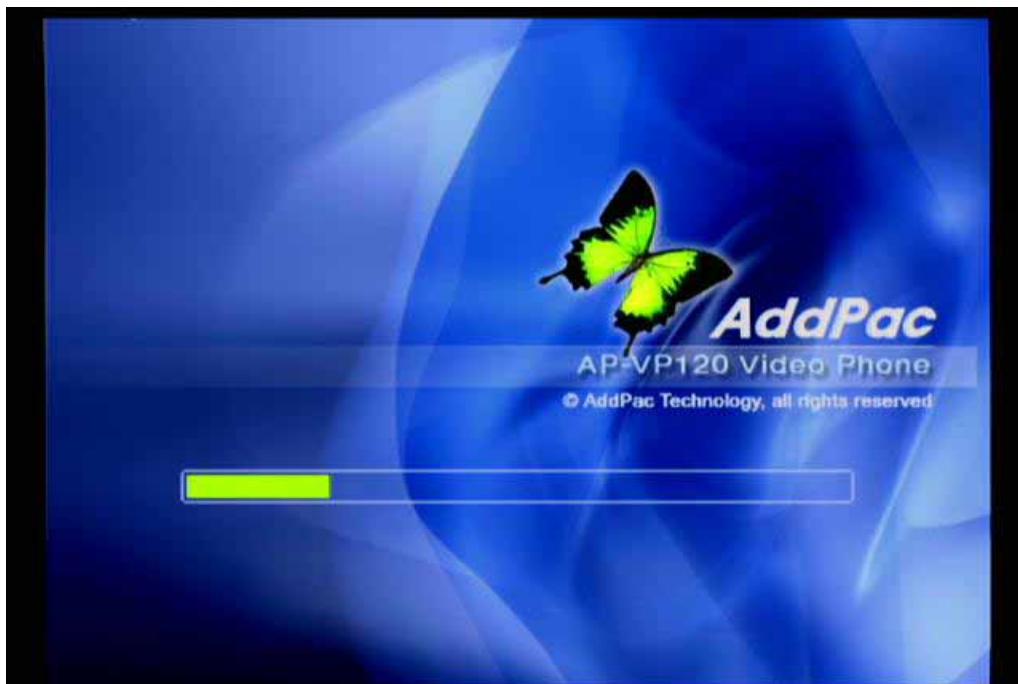

(Figure 4-1) Startup Booting Screen

Default Screen Layout





The following figure shows layout display of basic screen, after the startup booting screen is finished.



(Figure 4-2) Default Screen Layout

[Table 4-1] Description of Layout Display of Basic Screen

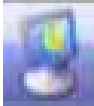
No	Description
Top Info Bar	View Mode
	Local View: The default screen while AP-VP120 is not in use for a video call. The basic image of the video input is displayed
	Remote View : Displaying the video image transmitted from the other party during the call
	Conversation View: Splits the screen and displays the local and remote video images
	Camera Control : Displays the camera control mode when PTZ button of the remote control is pressed.

Time	<p>Displaying the present time. The time for call duration is displayed when the call is on line. During the call, the present time can be displayed by pressing INFO on the remote control</p>
	<p>Displaying AP-VP120 is connected to the broadcasting system</p>
	<p>Displaying up/down of the link for WAN interface</p>
	<p>Blinks for arrival of the incoming call. It is enabled while the call is on line. When the call arrives during user's absence, it blinks periodically.</p>
	<p>Displays more than one subscriber numbers (Multiple Subscriber Number for different purposes. For instance, you need 2 different phone numbers, one for your desk and the other one for the meeting room</p>
	<p>Turns on/off LCD screen</p>
Video in Screen	<p>Displays the video image which has been entered to the video input port while the call is not received or placed.</p> <p>Displays local/ remote/ convention view depending on the user's mode setting while the call is received or placed. OSD menu is also displayed on this screen.</p>







Menu Composition

When you press the menu button of the remote control, you can see the menu in the following figure. By using this menu, you can set up all the functions except pan/tilt of remote camera, changing the layout and verifying call status, which can be during online call state. You can still use the menu while you are remaining on line.



(Figure 4-3) Main Menu

[Table 4-2] Description of Menu Composition

Item	Description
	Phonebook menu is a phone directory with the registered phone numbers, names and Number Search, Recent Call List and Speed Dial List.
	Tool Box Menu provides the convenient functions for the user such as time setting of the device, saving the settings, initializing the settings, ringer sound selection, power saving and version information
	AV Setup is the essential menu for the AP-VP120, which configures the settings for audio input and output volume, the color and brightness adjustments, voice codec selection, video codec selection and audio input an output properties.
	Network & Call menu configures the setting for WAN, LAN interface, selecting VoIP protocol, SSCP, incoming call, enabling/ disabling HTTP, FTP service port, selecting one's own number, option details
	Applications menu allows you to use the supplementary functions such as VoD Browser, IPTV (to be available in future, Network Camera, Conferencing, Voice Message, File Browser
	Remote Setup menu allows you to change the the bandwidth and image size, frame rate of the other party, while the user is on a call (Applicable only to the call which has been applied with the setup. When the call is ended, it returns to a default value.

Using Input Mode

Input Mode takes the entry for some texts, numbers, special characters by using remote control.

The Input Mode is used for managing Phone Book, account and IP address entry in network configuration settings, so you should know thoroughly. Each function key corresponds to F1~F4 of the remote control.

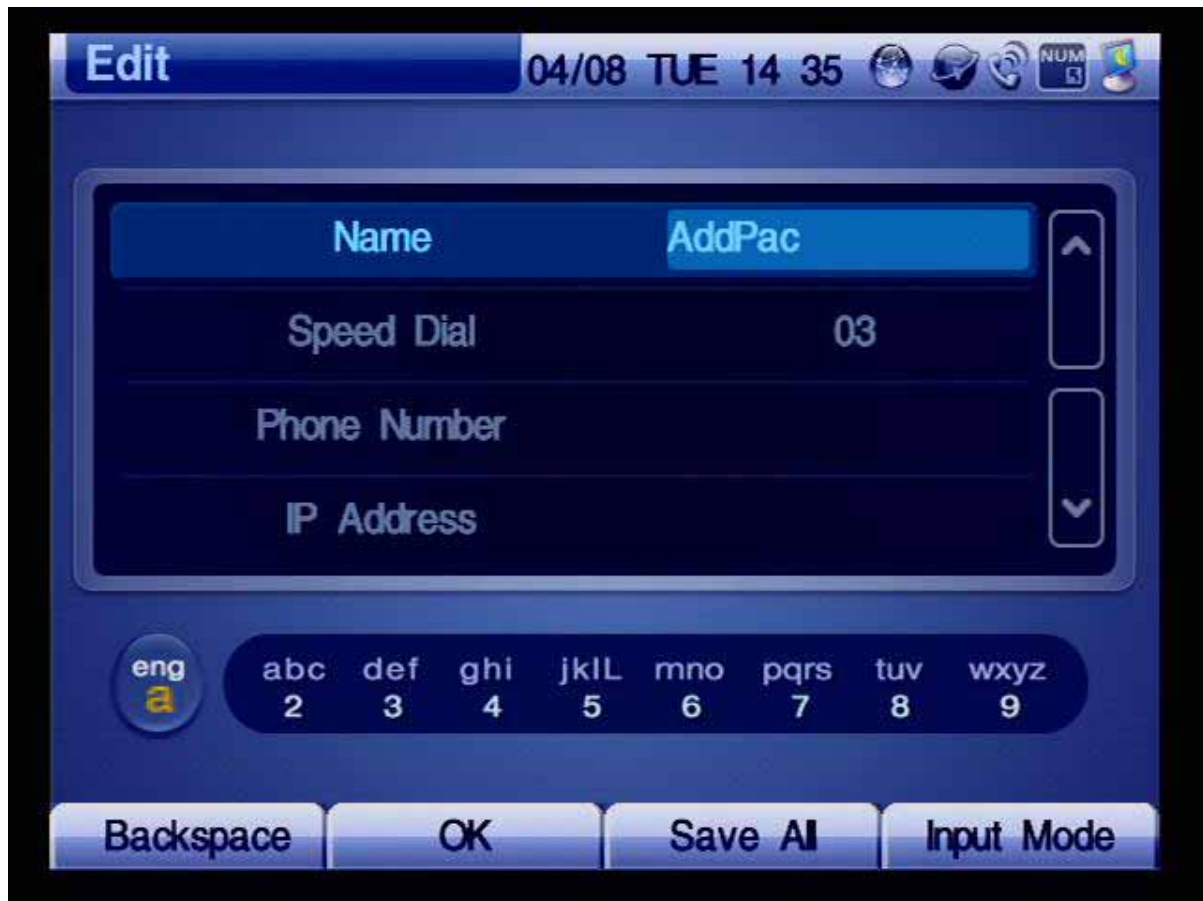

(Figure 4-4) Input Mode

[Table 4-3] Description of Input Mode

Softkey	Description
Character Set (F4)	To input letters in OSD by using the remote control, use Character Set. By using 4 function buttons of the remote control, you can have 6 different kinds of character sets as they are shown in Figure 4-5. To enter the relevant letters, you need to press the numeric keys of the remote control 1 to 3 times. To enter the next set of letters, press the left or right button of the navigation key of the remote control for more than 3 seconds..
Erase (F1)	Use the backspace key to correct an error made during the text entry.
Save/Edit (F2)	When the system is rebooted, all the values that have been entered disappear. Thus, use this SAVE key to save all the values that have been entered. For some entries, this key can be used as EDIT also.

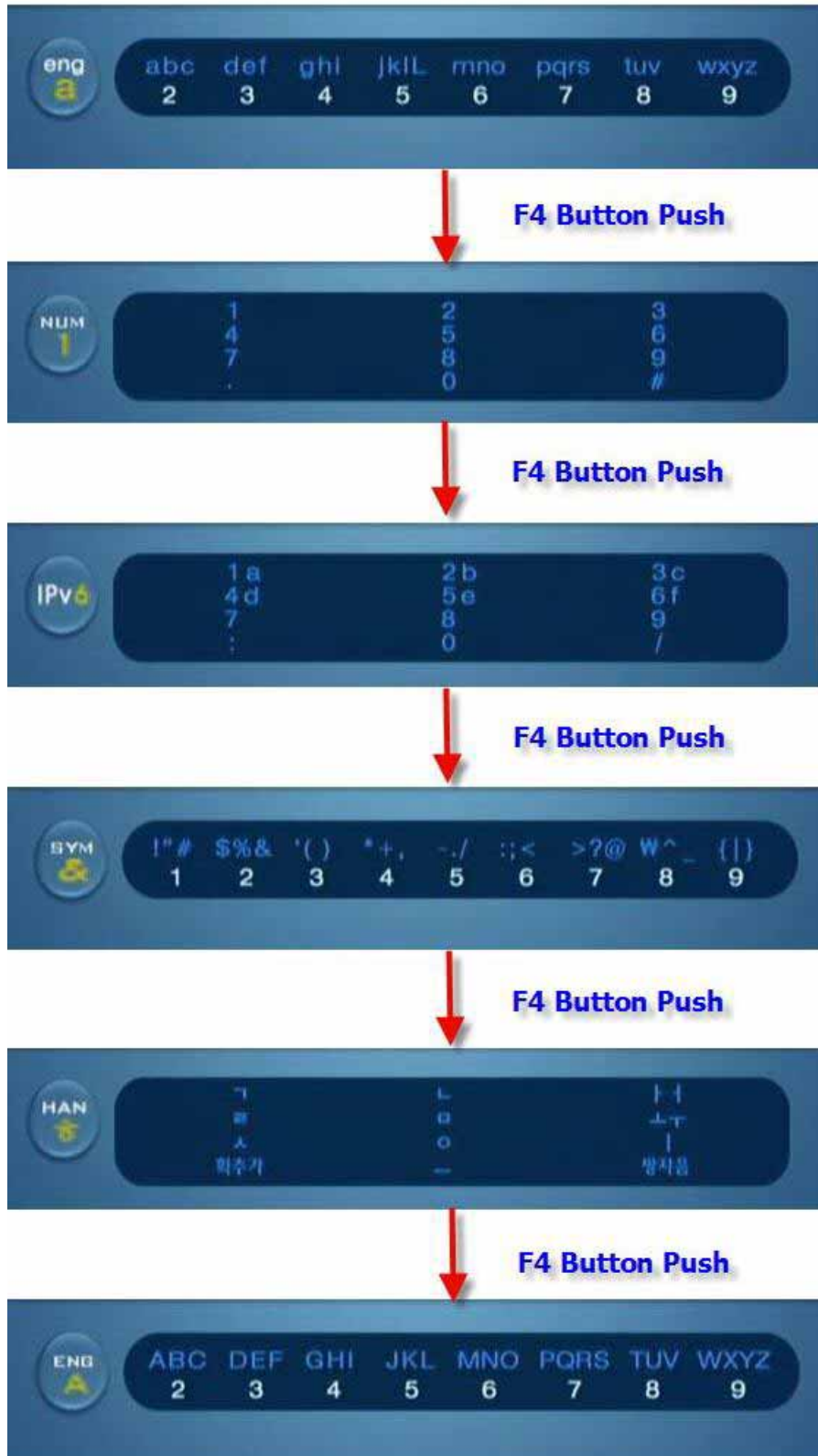

(Figure 4-5) Changing the Input Mode by Pressing F4 on the Remote Control





Phone Book Menu

Phone Book Menu is a phone directory and it consists of Name or Number Search, Phone Number Registration, Recent Call, Speed Dial:



(Figure 4-6) Phone Book Menu

[Table 4-4] Composition of Phone Book Menu

Menu Category	Description
	Searches a phone number by using a registered name in the Phonebook. The user can enter the name by using the remote control to find the phone number and then press Call on the remote control to place a call.
	Searches a phone number which has been registered to the Phonebook. The user can enter the name by using the remote control to find the number and then press Call on the remote control to place the call.
	To register a new phone number, use Register. Name, number, IP address, transmission settings can be specified.
	Speed Dial displays 7 names per screen in the order of Speed Dial numbers associated with name and numbers. So the user can find the other party's name quickly and place the call.
	Recent Call reads the recent call list. The list provides caller number, name and IP address. So the user can find the other party's name quickly and place a call to the caller.

Phone Book - Search by Name



(Figure 4-7) Screen Layout of Search by Name

Figure 4-7 shows the screen by locating OSD>> Phone Book>> Search by Name. The Search by Name menu searches the other party's name which has been saved. Thus, whenever the user enters a letter of a name by using the remote control, the search moves to the matching field of the name. If the first letter of the field is found same more than twice, enter the second letter to search the number that you want to find. You can also place the call by using the information of the party found or revise the information.

Figure 4-8 shows searching a specific name from the Name Search Menu by using the remote control:



(Figure 4-8) Menu >> Phonebook



(Figure 4-9) Phonebook >> Name

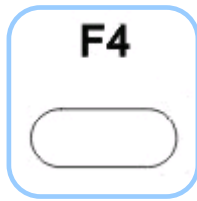

(Figure 4-10) Search by Name

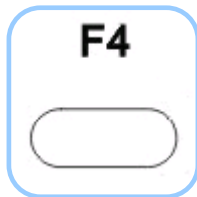

(Figure 4-11) Enter "t" from Character Set

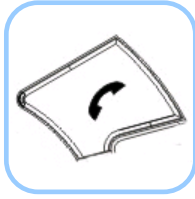

(Figure 4-12) Select the searched name in the list and place a call to the searched name, 'test', by pressing Call on the remote control

Phone Book - Search by Number



(Figure 4-13) Screen Layout of Search by Number

Figure 4-13 shows the screen by specifying OSD>> Phonebook>> Search by Number. The Search by Number menu searches the other party's number in the Phone Book. Thus, whenever the user enters a number by using the remote control, the search moves to the matching field of the number. If the first number of the filed is found same more than twice, enter the second number to search the number that you want to find. You can also place the call by using the information of the party found or revise the information.

Figure 4-14 shows searching and editing a specific number from the Search by Number menu by using the remote control:



(Figure 4-14) Menu >> Phonebook



(Figure 4-15) Phone Book >> Search By Number



(Figure 4-16) Search by Number



(Figure 4-17) Entering '1003' by using the keypad



(Figure 4-18) Automatically searching the phone number starting with 1003

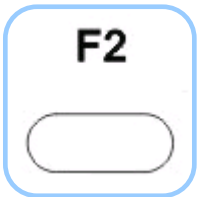

(Figure 4-19) Select Edit Mode by pressing F2 on the remote control

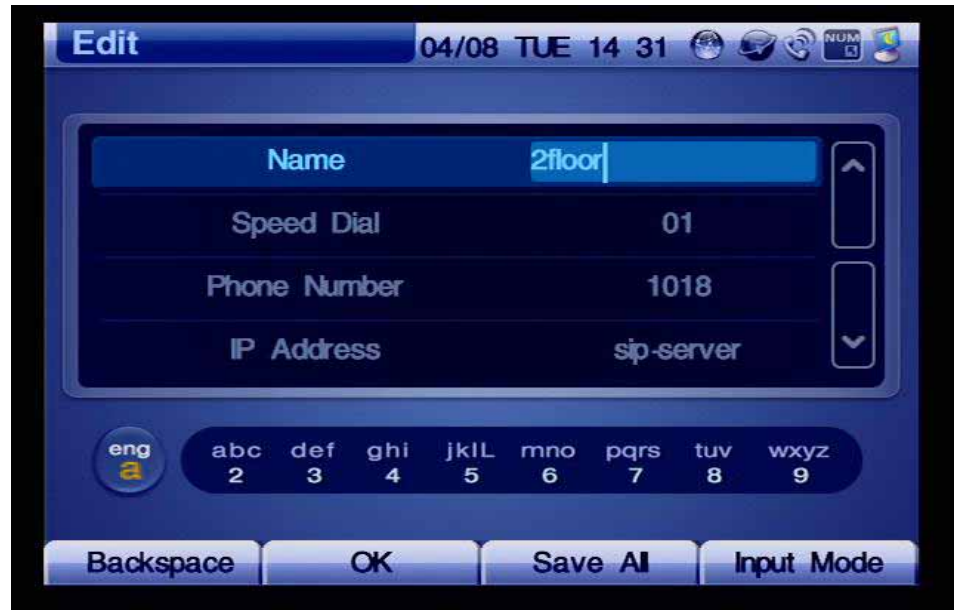

(Figure 4-20) Move to IP Address by pressing the Navigation Key on the remote control

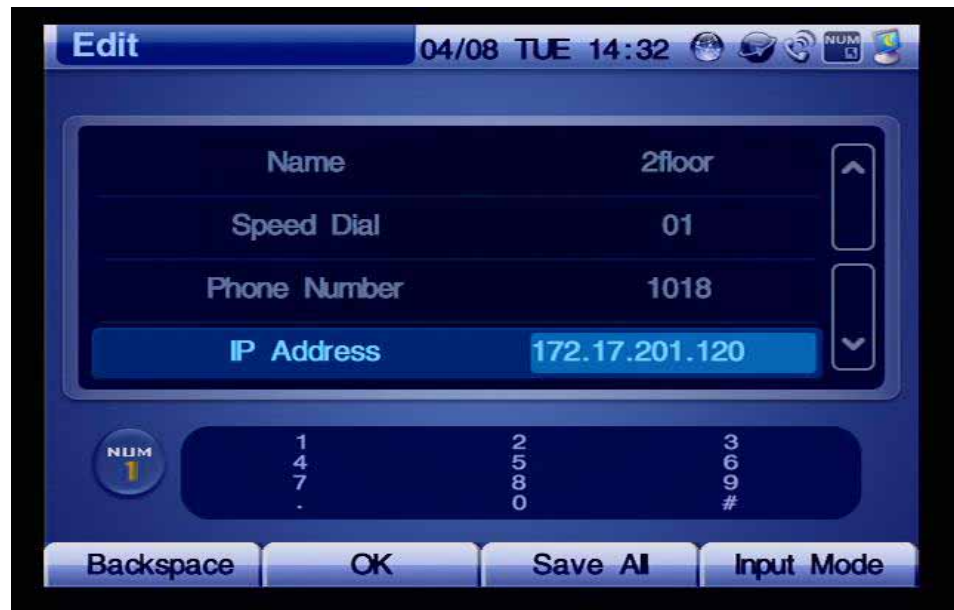

(Figure 4-21) Change the IP address to "20.1.1.1"

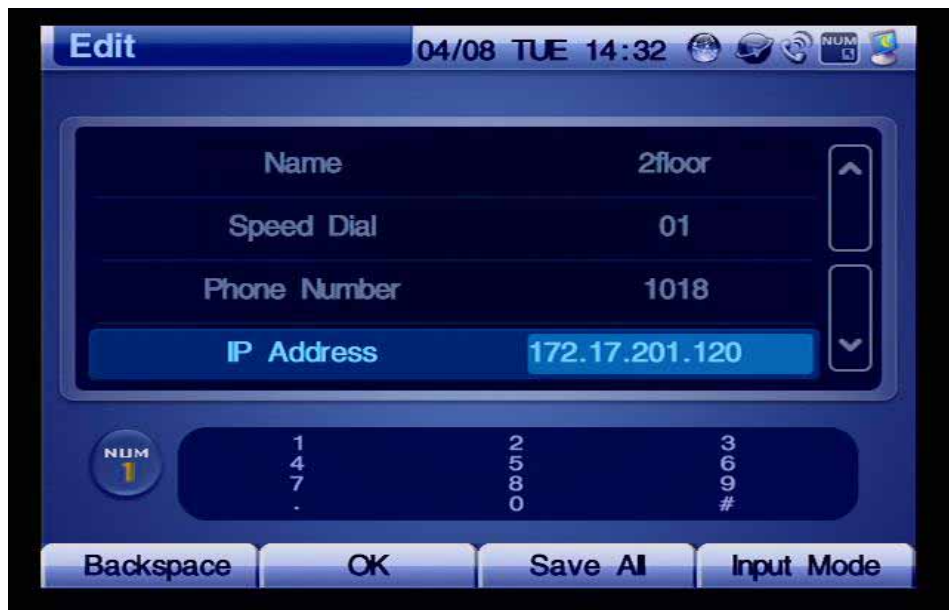
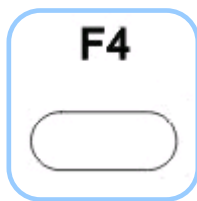

(Figure 4-22) Press 'OK' on the remote control and then press 'F3' to save the changed setting

Phone Book - Registration

Figure 4-23 shows the screen for selecting OSD>> Phone Book>> Registration. The Registration Menu is to add a new phone number to the Phone Book. The user enters the other party's name, number, IP Address for registration. Once the phone number is saved, the Speed Dial Number is registered automatically.



(Figure 4-23) Registration Menu

Figure 4-24 shows an example for registering a new number by using the remote control.



(Figure 4-24) Menu >> Phone Book



(Figure 4-25) Phone Book >> Registration

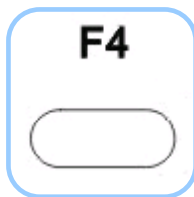

(Figure 4-26) Registration

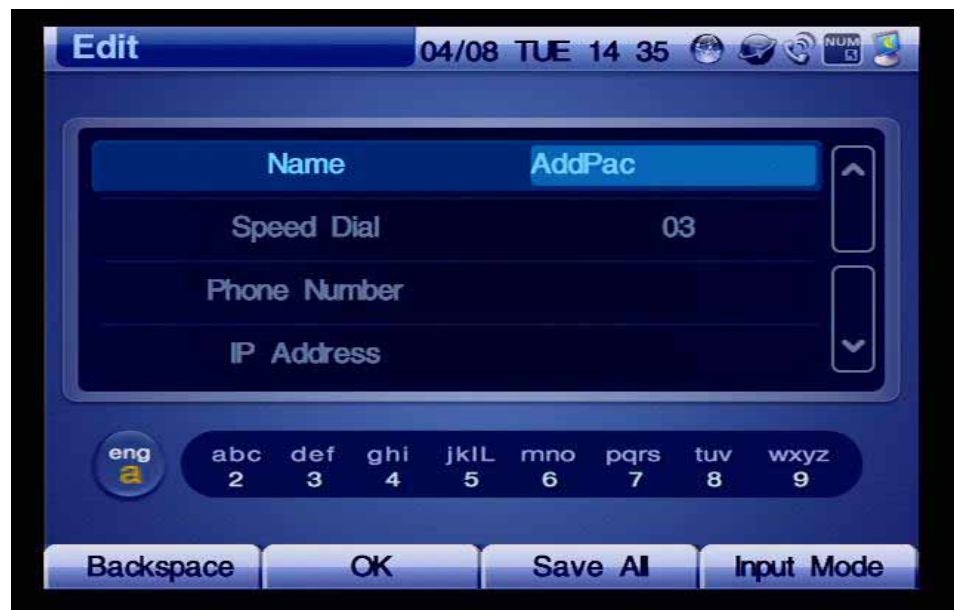

(Figure 4-27) Entering a Name by Using F4 and the Numeric Key on the Keypad

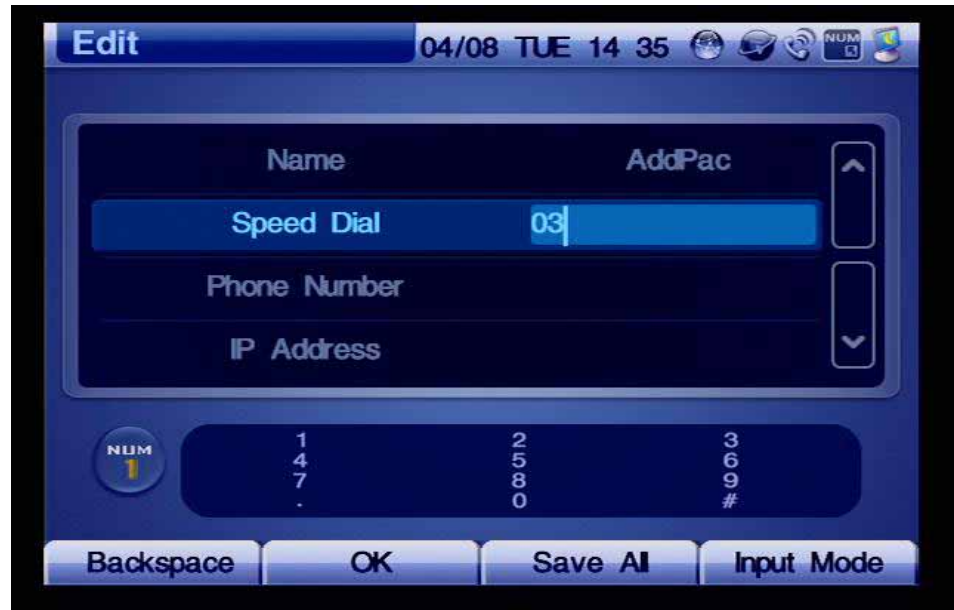

(Figure 4-28) Entering a Speed Dial Number by Using the Numeric Button on the Keypad.



(Figure 4-29) Enter a Phone Number

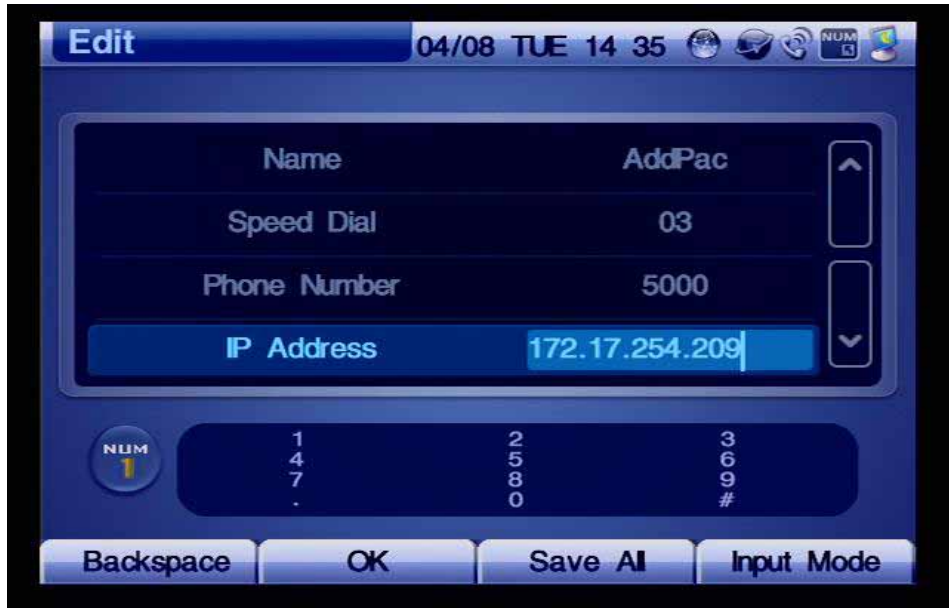

(Figure 4-30) Specifying IP address.



(Figure 4-31) Selecting the Option for Video Codec

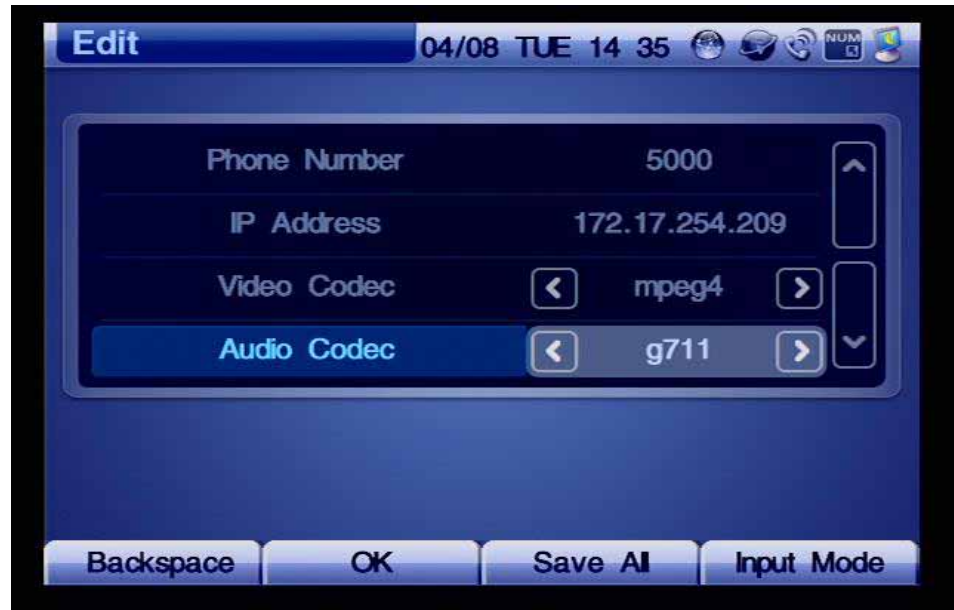

(Figure 4-32) Selecting the Option for Audio Codec



(Figure 4-33) Selecting the Option for Image Size



(Figure 4-34) Selecting the Option for Frame Rate



(Figure 4-35) Pressing OK and then Pressing F2 to Save

Phone Book - Recent Call

Figure 4-36 shows Recent Call by specifying OSD >> Phone Book >> Recent Call. Recent Call display the other party's information for details of all incoming and outgoing calls, including the time of the calls. The user may be able to choose a number to call from the Recent Calls List and checks a call during one's absence and save the incoming number.

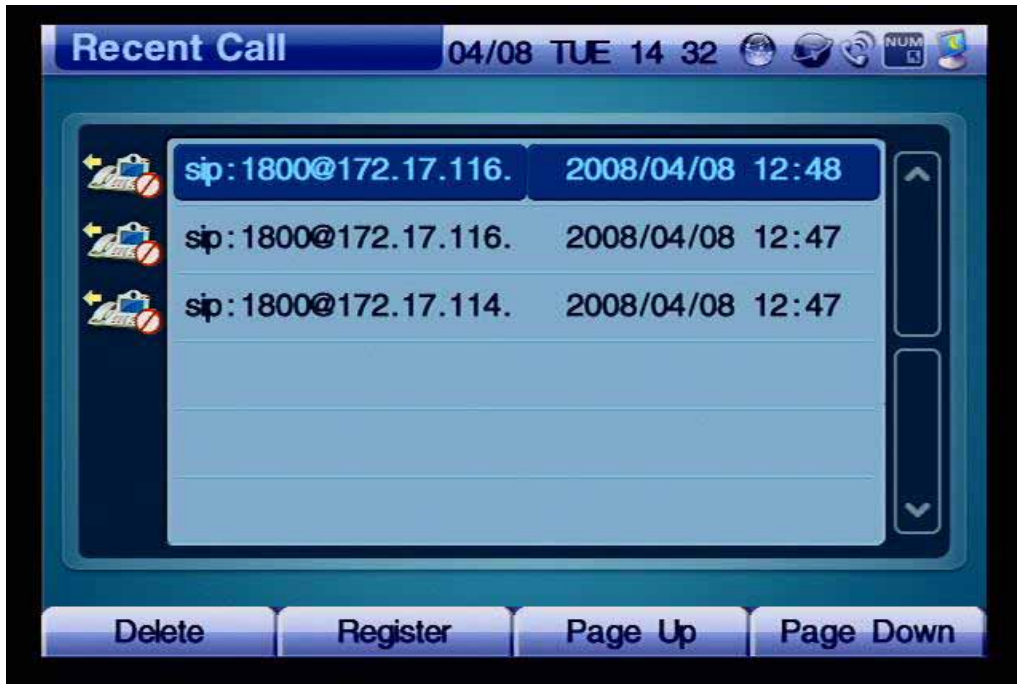



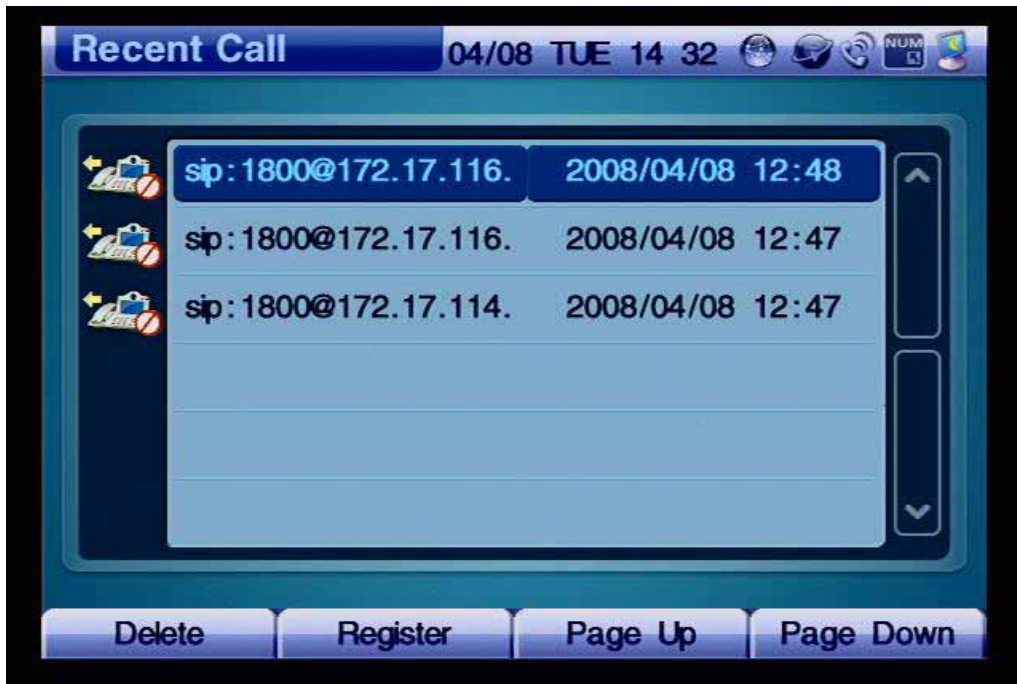





(Figure 4-36) Recent Call



(Figure 4-37) Screen Layout of Recent Call

Table 4-5 describes the Recent Call menu options in Figure 4-36.

[Table 4-5] Description of Recent Calls

Option	Description
Incoming/ Outgoing	 Displays an incoming voice call
	 Displays an unanswered incoming voice call
	 Displays an outgoing voice call
	 Displays an unanswered outgoing voice call
	 Displays an incoming video call
	 Displays an unanswered incoming video call
	 Displays an outgoing video call
	 Displays an unanswered outgoing video call

Index Number	Displays the index number in the Phonebook
Remote Information	Displays the other party's call information of H.323 ID for H.323 protocol and SIP Protocol as URL
Phone Number	Displays the other party's call number
Call Duration	Displays the time consumption between the instant an off-hook condition at each end
Delete (F1)	Deletes the call record
Register (F2)	Saves the session information
Page Up (F3)	Moves to the last page
Page Down (F4)	Moves to the next page

Figure 4-37 shows an example of placing a call by using the incoming call information from the Recent Call.



(Figure 4-38) Menu >> Phone Book



(Figure 4-39) Phonebook >> Recent Call



(Figure 4-40) Recent Call



(Figure 4-41) Choose the most recent phone number

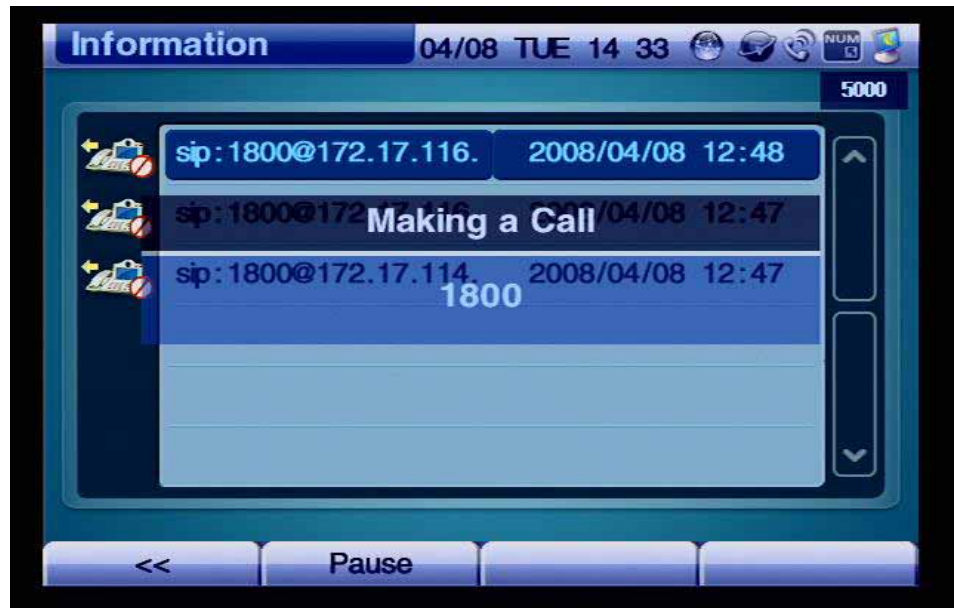

(Figure 4-42) Place a call by pressing Call on the key pad.

Phone Book - Speed Dial

Figure 4-43 shows Speed Dial by specifying OSD >> Phone Book >> Speed Dial. The Speed Dial menu has a list of Index Numbers and Names. The list with 8 Index Numbers and Names can be displayed on one screen and helps to find the other party's number quickly. When a name is selected, the relevant details of information are displayed at the lower end, so you can make a call right away.



(Figure 4-43) Screen Layout of Speed Dial Number



(Figure 4-44) Screen Layout of Speed Dial Number

Table 4-6 describes Speed Dial Number Layout in Figure 4-44.

No.	Description
Index Number	Index Number in the Phonebook
Name	Name in the Phonebook
Phone Number	The other party's call number
IP Address	The other party's IP Address
Video Codec	The video codec information
Audio Codec	The audio codec information
Delete	Delete the Speed Dial Number
Edit	Edit the registered Speed Dial Number Information
Page Up	Move to the last page
Page Down	Move to the next page

From Figure 4-45 the examples for placing the call by the Speed Dial Number are shown.



(Figure 4-45) Menu >> Phone Book



(Figure 4-46) Phone Book >> Speed Dial Number



(Figure 4-47) Choose '00' for Speed Dial



(Figure 4-48) Press Call on the Keypad to place a call









Tool Box Menu

Tool Box is organized by Date & Time, Save all, Factory Default, Ring, Power Save.

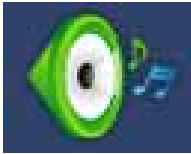

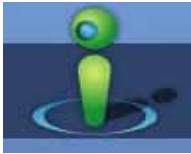
(Figure 4-49) Tool Box Menu Category

[Table 4-6] Tool Box Menu Components

Component	Description
	Takes the time entry and changes
	Saves all the changes have been made in OSD
	Initializes the settings of AP-VP120 to the factory default.
	Changes the ringer sound of AP-VP120
	Power Saving options for LCD/ Camera.
	Informs the version of the firmware.
	Selects a language.
	Locks the entry to administrator.
	Locks AP-VP120

Tool Box - Date&Time

This menu configures the settings for Date&Time of AP-VP120. You can use the remote control to enter the date and time and press F2 to save afterwards.



(Figure 4-50) Date&Time Options



(Figure 4-51) Menu >> Tool Box

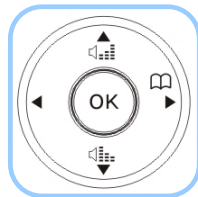

(Figure 4-52) Menu >> Tool Box >> Date&Time



(Figure 4-53) Date&Time Menu Details

[Table 4-7] Description of Date&Time Menu Details

Category	Description
Year	Enter the present year of the system
Month	Enter the present month of the system
Day	Enter the present day of the system
Hour	Enter the present hour of the system
Minute	Enter the present minute of the system
Second	Enter the present second of the system

Tool Box - Save All

This command saves the values which have been entered in OSD. The values are still saved as they are even after the reboot of AP-VP120.



(Figure 4-54) Save All Main Screen

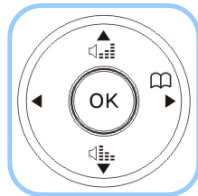

(Figure 4-55) Menu >> Tool Box >> Save All



(Figure 4-56) Press OK on the Keypad to Confirm Your Selection of Saving



(Figure 4-57) 'Writing data' message is displayed



(Figure 4-58) Verifying the Display of 'Writing success'

Tool Box - Factory Default

This command is not recommended for use unless the user really needs to erase and reset all contents of Configuration, Phonebook and Recent Call.

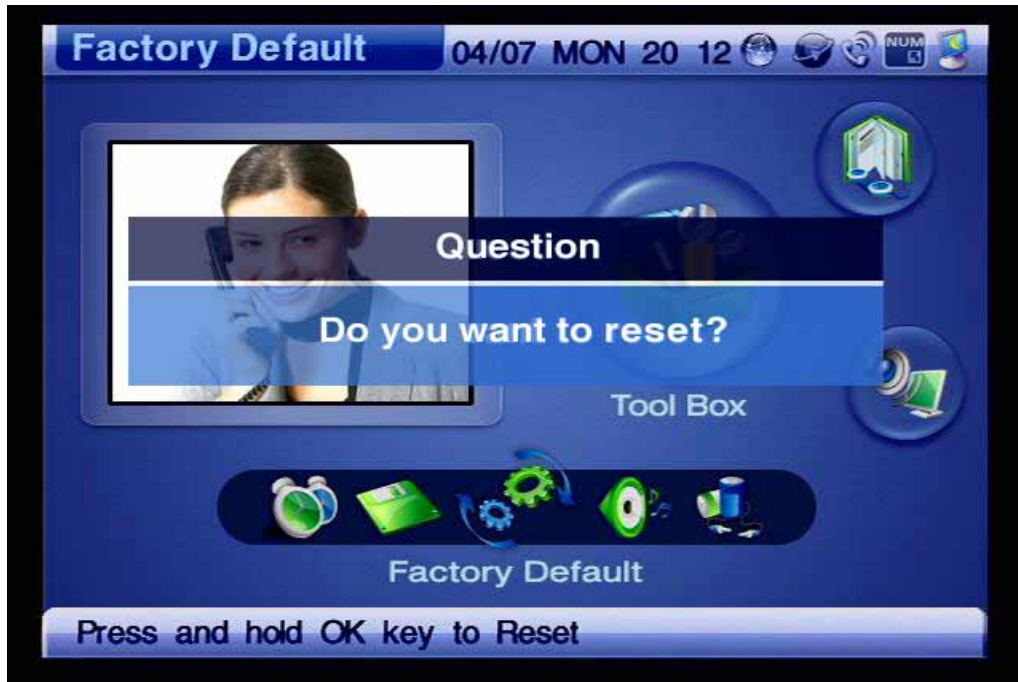

(Figure 4-59) Factory Default Menu Section



(Figure 4-60) Menu >> Tool Box >> Factory Default



(Figure 4-61) Press OK for 3 seconds



(Figure 4-62) All the settings are erased and automatically reset and reboot

Tool Box - Ring

Ring menu provides 11 different kinds of sounds for the incoming call including the mute. The user may use F1 key (Play to listen the sounds and choose the one that the user like. Also this menu allows the user to turn up or down the volume for the ringer sound.



(Figure 4-63) Screen Layout of Ring Menu Details



(Figure 4-64) Menu >> Tool Box

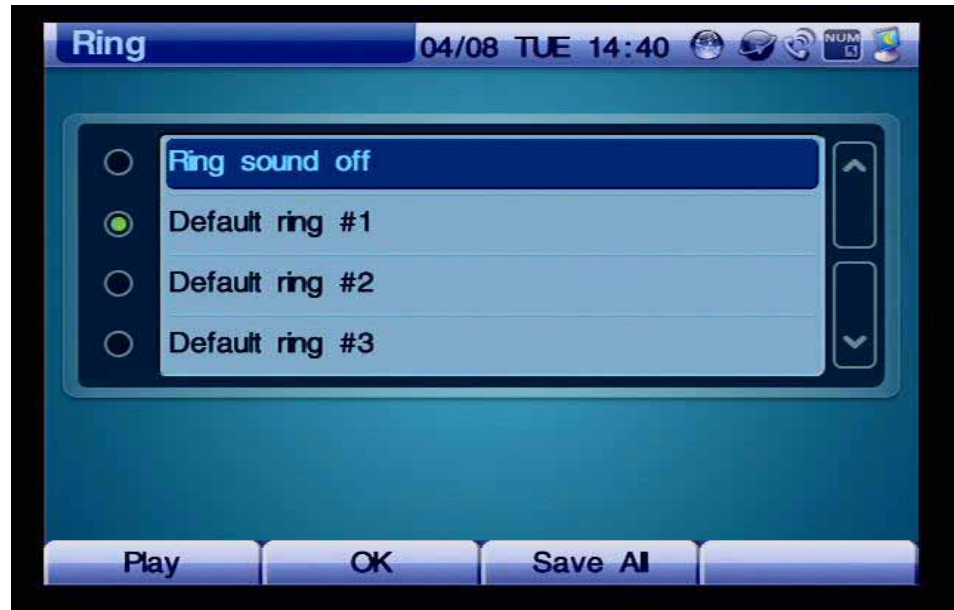

(Figure 4-65) Choosing a ringer sound from the given options

Tool Box - Power Save

The Power Saving turns off the LCD screen and the built-in camera automatically, in a time specified by the user. By touching the touchscreen or pressing any button on the keypad, the user can turn on the screen and camera. **To optimize the lifetime and quality of the LCD screen and camera, using this menu is recommended.**



(Figure 4-66) Power Save Menu Details

As it is shown in Figure 4-68, the user may choose one of the time options, which are 15 seconds, 30 seconds, 1 minute, 3 minutes and 10 minutes (default setting: 30 seconds).



(Figure 4-67) Menu >> Tool Box >> Power Save



(Figure 4-68) Time Options for Power Save

Tool Box - Information

This menu verifies the present version of the software (firmware of the AP-VP120).



(Figure 4-69) Information Menu Component



(Figure 4-70) Menu >> Tool Box >> Information

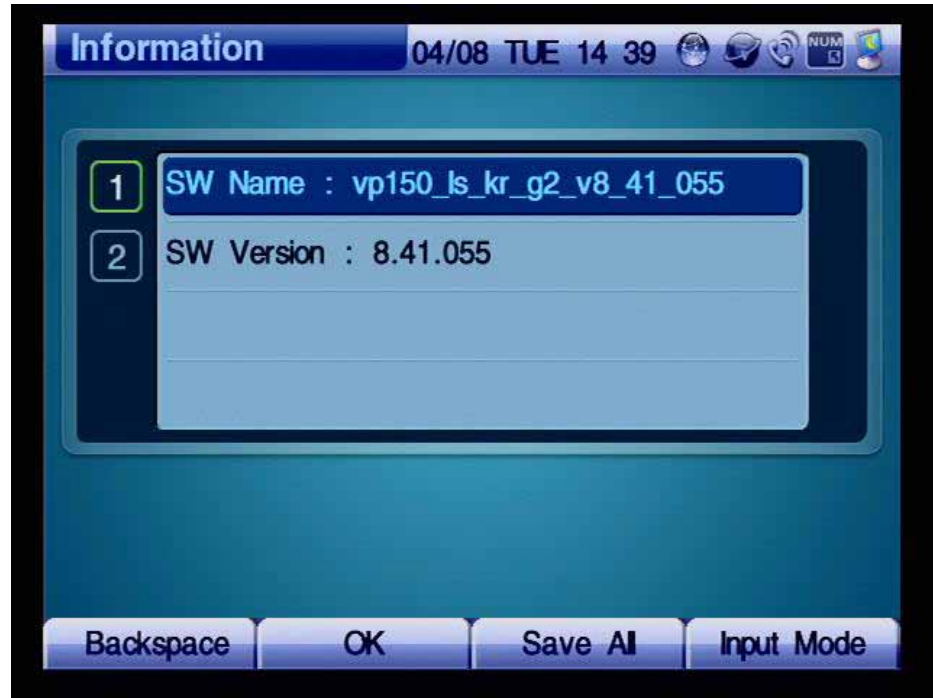

(Figure 4-71) Displaying the version

[Table 4-8] Description of Information Details

Name	Description
SW Name	The file name of the firmware being implanted to the AP-VP120
SW Version	The version name being implanted to the AP-VP120

Tool Box - Language

This menu verifies the language in use and selects the choice of language for the AP-VP120.



(Figure 4-72) Language Setup Options



(Figure 4-73) Menu >> Tool Box >> Language

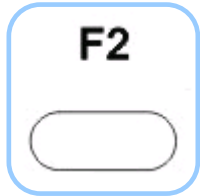

(Figure 4-74) Language Setup

[Table 4-9] Description of Language Setup Options

Language	Description
English	English setup mode
Korean	Korean setup mode

Tool Box - Admin Lock

Admin Lock menu component configures the settings to block the entry to a particular menu and changes the password. '2337' is set at the default. **Keeping the same password is recommended.**



(Figure 4-75) Password Menu Details

[Table 4-10] Description of Password Options

Option	Description
Use Password	Enables or Disables Password (default : Disable) If Password is enabled, you must enter the password for entering the menus of Factory Default, Internet Setup, VoIP Setup, Message, Register and Speed Dial
Change Password	Replaces the old password with the new one
Admin Lock Option	Selects the menu component to be locked by password. The available menu components are Factory Default, Internet Setup, VoIP Setup, Service Port Setup, SSCP Setup and Application Setup.

The example for setting the password is presented from Figure 4-76.



(Figure 4-76) Menu >> Tool Box



(Figure 4-77) Menu >> Tool Box >> Admin Lock



(Figure 4-78) Admin Lock Menu Details

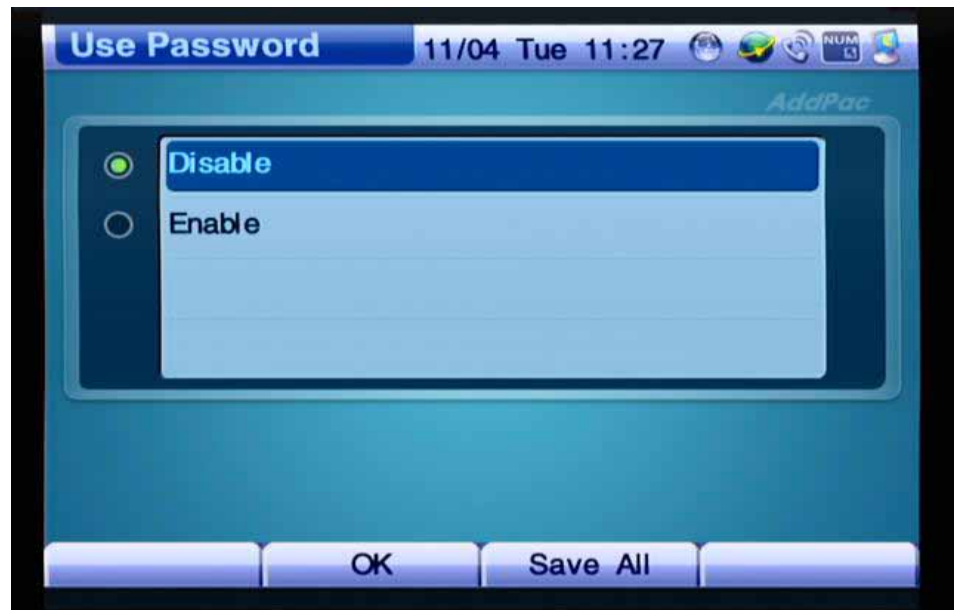

(Figure 4-79) Use Password Options

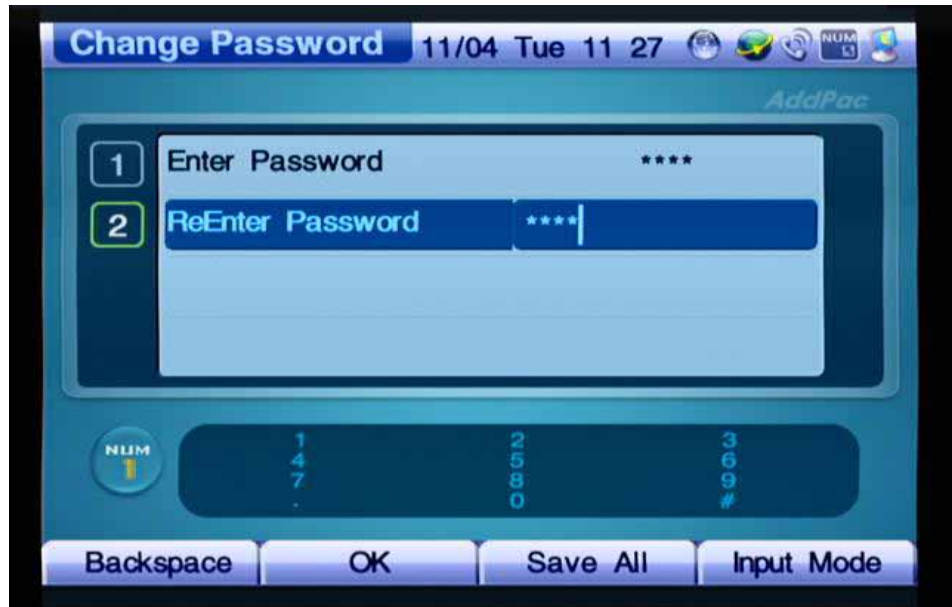

(Figure 4-80) Change Password Options

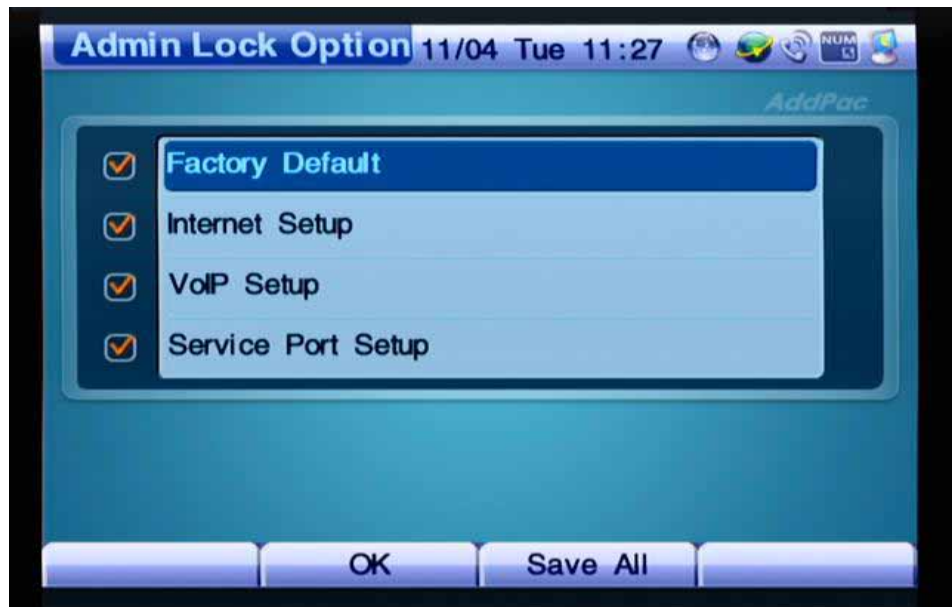
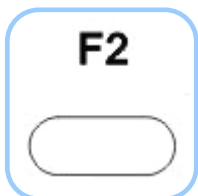

(Figure 4-81) Admin Lock Option

Tool Box - User Lock

User Lock menu component configures the settings to block the entry to a particular menu section and changes the password. '2337' is set at the default. **Keeping the same password is recommended.**



(Figure 4-82) User Lock Menu Sections

[Table 4-11] Description of User Lock Menu Sections

Option	Description
Use Password	Enables or Disables Password (default : Disable) If Password is enabled, you must enter the password for entering the menus of Factory Default, Internet Setup, VoIP Setup, Message, Register and Speed Dial
Change Password	Replaces the old password with the new one
User Lock Option	Selects the menu section to be locked by password. The available menu sections are Incoming Lock, Outgoing Lock, and Menu Lock.

The example for setting the password is presented from Figure 4-83.



(Figure 4-83) Menu >> Tool Box



(Figure 4-84) Menu >> Tool Box >> User Lock

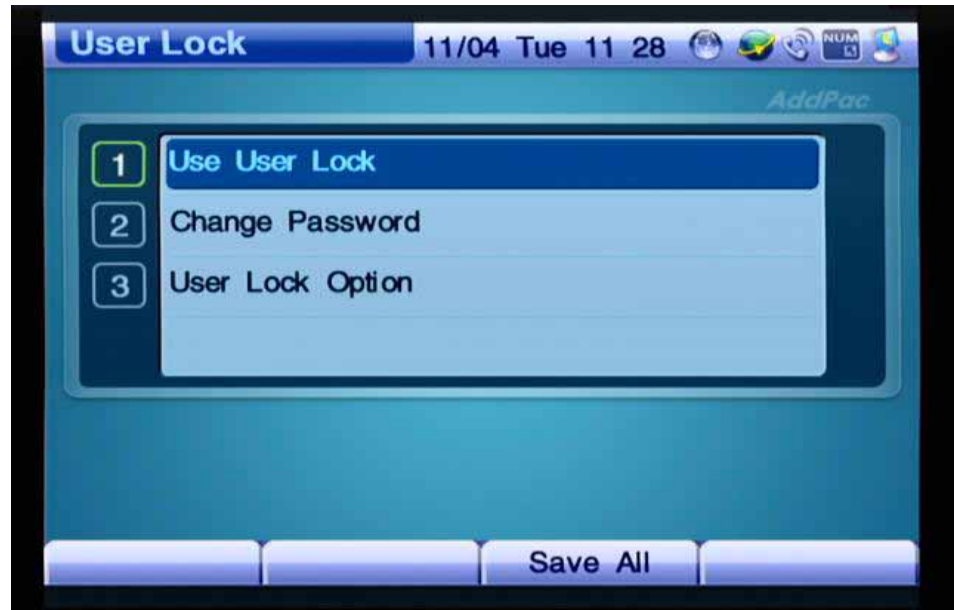

(Figure 4-85) User Lock Menu Sections

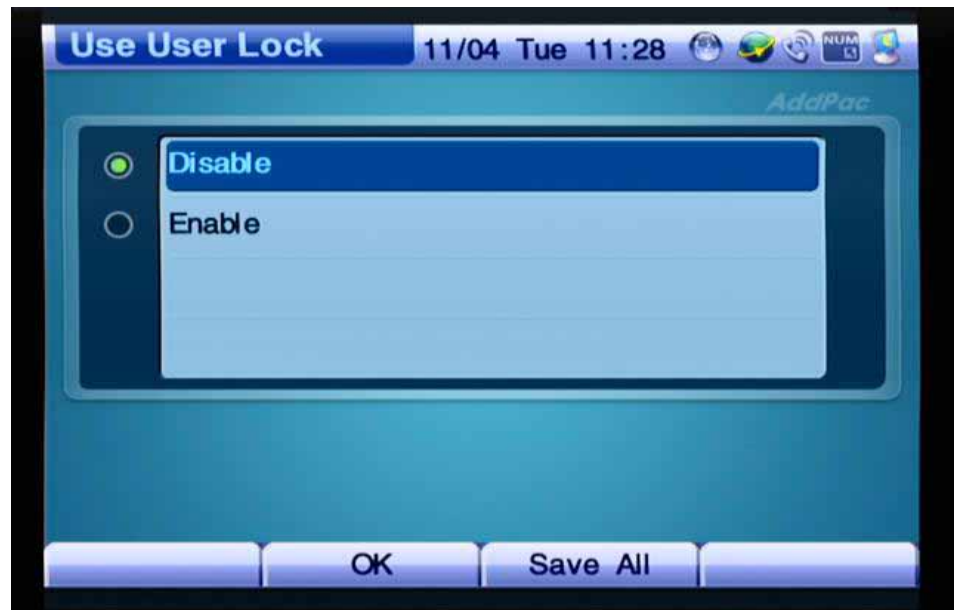
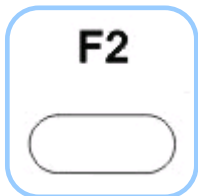

(Figure 4-86) Use User Lock Options

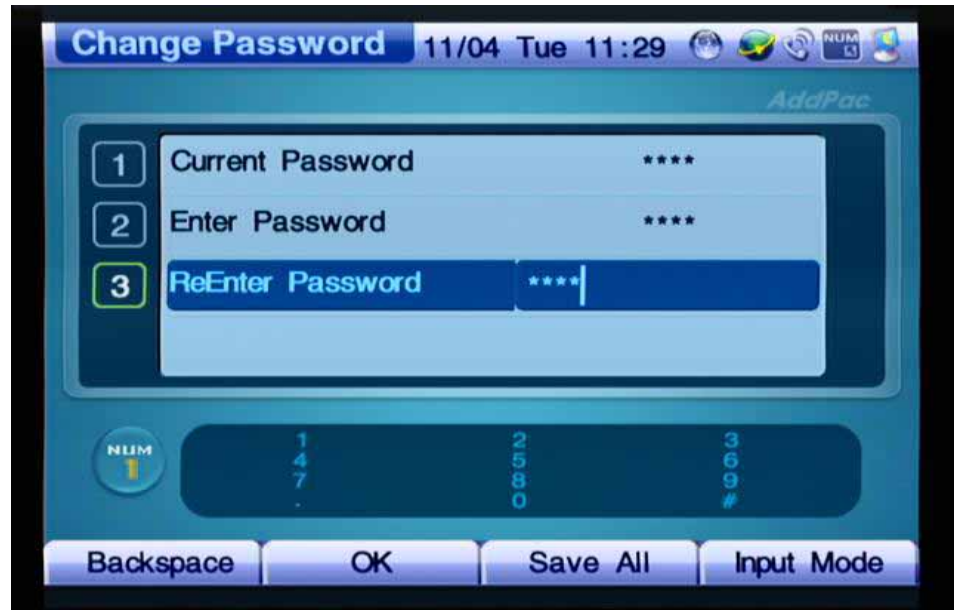

(Figure 4-87) Change Password Options

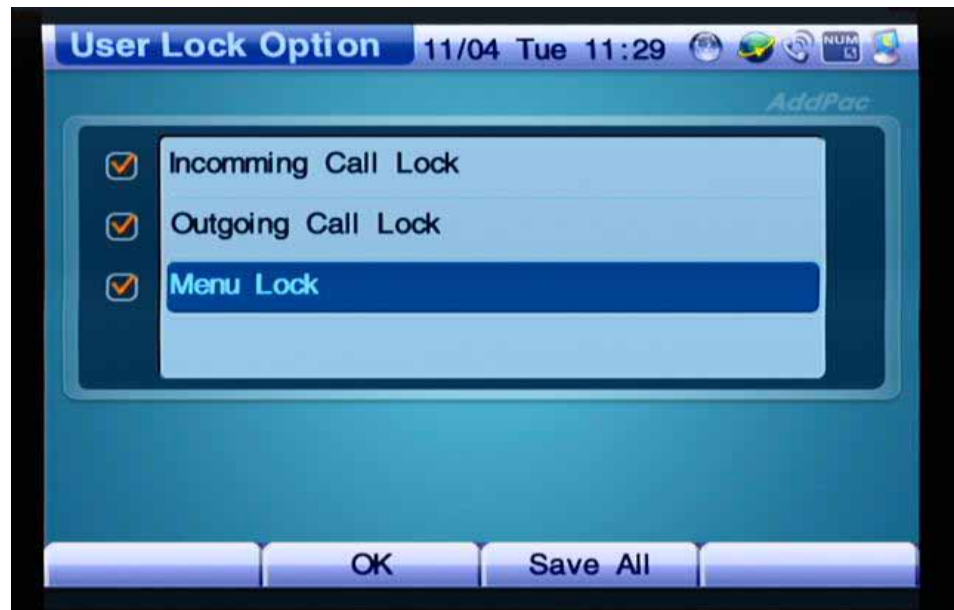

(Figure 4-88) User Lock Option Options

AV Setup Menu

Audio/ Video Setup menu configures the basic settings for video call and conference. This menu has Bandwidth, IO Ports, Camera and Display. The features of this menu are mainly dealt with the video and audio. The user can control all features, by using the remote control; most of these functions can be selected and applied on the real-time basis, even during a call.



(Figure 4-89) AV Setup Menu Section

[Table 4-12] Description for Composition of AV Setup Menu Sections

Menu Section	Description
	<p>Configures the setting of both local and remote cameras and Pan/Tilt for the video call by connecting the external camera to the AP-VP120.</p>
	<p>Adjusts the ring volume for the built-in speaker volume and audio input and output port volume. The user may adjust the volume by moving along with the slide type of bar.</p>
	<p>Adjusts the definition and brightness of the Composite RCA Video Input and Composite RCA Video and S-VHS Output.</p>
	<p>Determines the type option of audio codec for the audio input and output port. The available type options are G.711 (PCM), G.726 (ADPCM), G.723 and G.729.</p>
	<p>Adjusts MPEG4/H.263, resolution, frame rate. Depending on the network condition, you can select the optimal video quality.</p>
	<p>Sets the bandwidth ranging from 128Kbps to 4160Kbps at maximum.</p>
	<p>Controls the properties of the speaker/ line-out of the audio output port and microphone/ line-in of the audio input port. Also controls the properties of the input and output port of the external audio equipment.</p>

AV Setup - Volume

Volume menu adjusts the volumes of the Audio Input and output, built-in speaker and microphone amplification.

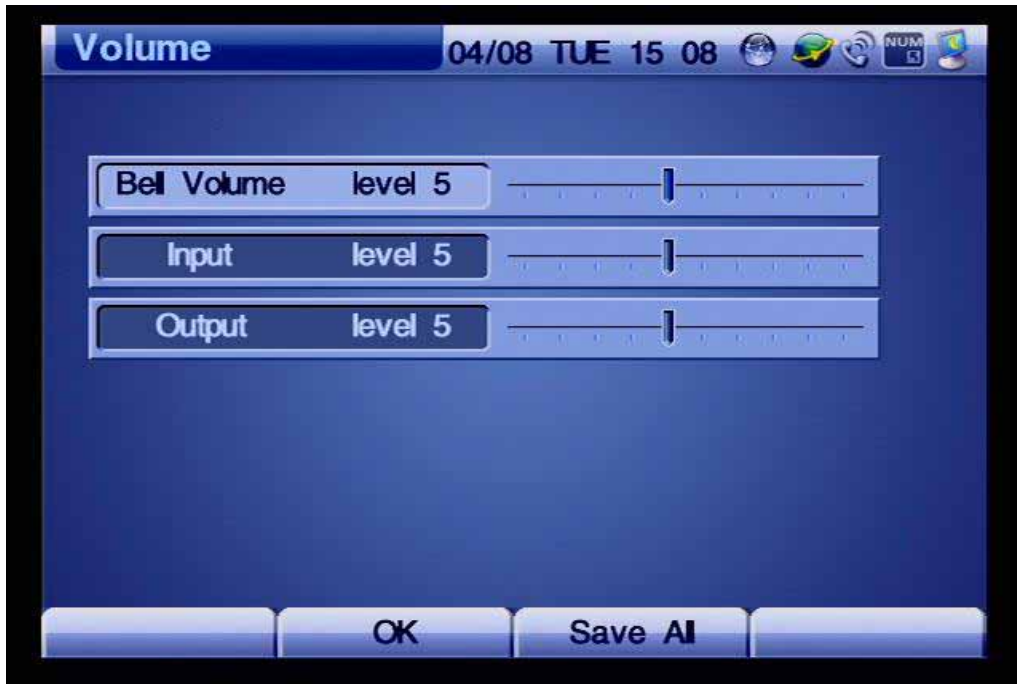

(Figure 4-90) Volume Menu Details

The example for adjusting the volume level for the Audio Input and Output ports are shown from Figure 4-60. The user may control the level by using the left/right navigation key on the remote control.



(Figure 4-91) Menu >> AV Setup



(Figure 4-92) Menu >> AV Setup >> Volume

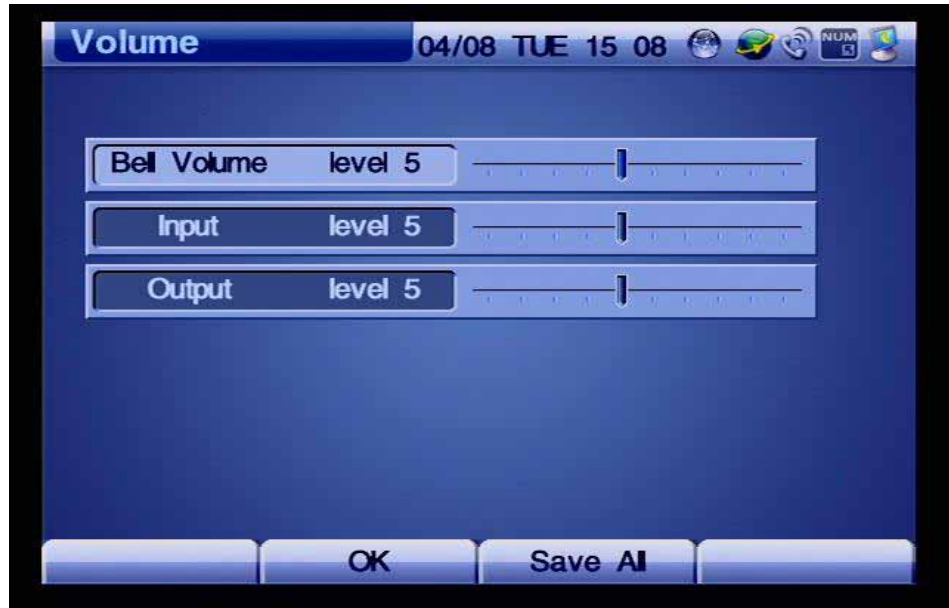

(Figure 4-93) Setting the Output volume to the level 5

[Table 4-13] Description of Volume Menu Details

Menu Details	Description
Bell Volume	Adjusts the loudness of the Bell Sound for the built-in speaker
Input	Adjusts the input volume of the built-in microphone
Output	Adjusts the output volume of the built-in speaker

AV Setup - Display

Display setup has Camera/ External Input (for the built-in camera and composite RCA video input and Monitor Output (for the built-in LCD and composite RCA video output or S-VHS. Camera/ External Input consists of brightness and Saturation. Monitor Output consists of SD, HD and LCD.



(Figure 4-94) Display Menu Details

[Table 4-14] Description of Display Menu Details

Menu Details	Feature
Camera Setting	Adjusts Brightness, Contrast and Color Saturation of the built-in camera and Composite RCA video input port and sets the option for enabling Mirror function. Use the Navigation key to scroll through the options. Press OK to make your selection.
Display	Adjusts Brightness, Red-Gain and Blue Gain of Composite RCA and S-VHS video output port which is displayed. Use the Navigation key to scroll through the options. Press OK to make your selection.
LCD Output	Adjusts Brightness, Red-Gain and Blue Gain of LCD output. Use the Navigation key to scroll through the options. Press OK to make your selection.



(Figure 4-95) Adjusting the Settings of Camera Input Screen

[Table 4-15] Description of Display Menu Options

Menu Option	Description
Camera Setting	Brightness Adjusts Brightness of Camera Input. 255 is the maximum value and 128 is set at default.
	Contrast Adjusts Contrast of the Camera Input. 64 is set at default.
	Saturation Adjusts Saturation of the video input. 68 is set at default.
	Horizontal Offset Adjusts the offset to maintain the horizontal position for composite video input. 8 is set at default
	Mirror Changes the image from the left to right. Mirror Effect is set to Off at default.
	Flickless Turns on or off by using F1 Softkey on the keypad or remote control. Flickless On state is for 50Hz frlorecent lamp. Flickless Off state is recommended in general.
Display	Brightness Adjusts Brightness of Composite/S-Video video output. The maximum value is 255. 128 is set at default
	Contrast Adjusts Contrast of Composite/S-Video video output. 64 is set at default.
	Saturation Adjusts Saturation of Composite/S-Video video output. The default setting is 68.
LCD Output	Brightness Adjust the brightness for the LCD output. The brightness is set to 50 at default.
	Red Gain Adjust the red gain level for the LCD output. Red Gain is set to 50 at default.
	Green Gain Adjust the green gain level for the LCD output. Green Gain is set to 50 at default.
	Blue Gain Adjust the blue gain level for the LCD output. Blue Gain is set to 50 at default
	Sharpness Adjust the Sharpness level for LCD output. The default setting is 7.

The example for adjusting display is shown from Figure 4-96.



(Figure 4-96) Menu >> Av Setup



(Figure 4-97) AV Setup >> Display



(Figure 4-98) Display >> Camera Setting

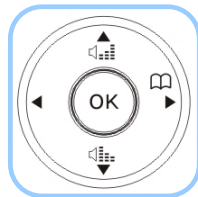

(Figure 4-99) Adjusting Brightness



(Figure 4-100) Adjusting Contrast

AV Setup - Audio Codec

The available codec types for selection are G.711 [PCM, G.729 and G.723.1. These audio codec types are arranged in a different preference depending on the user's environment. The user may select a set which can be most appropriate to the use's network settings and one's preference over audio quality.

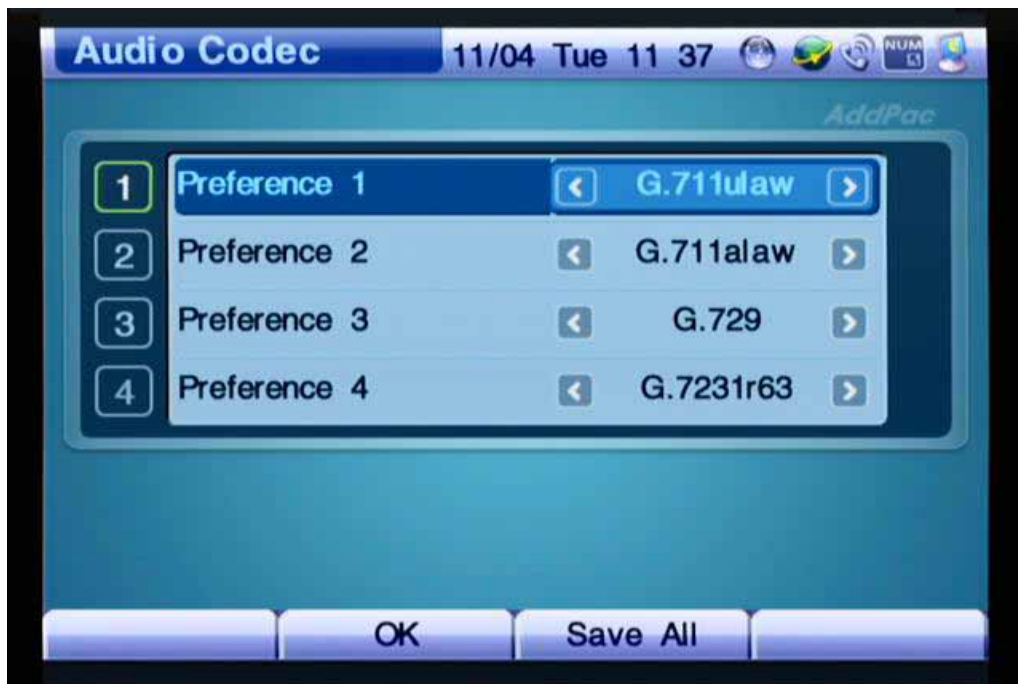

(Figure 4-101) Screen Layout for Audio Codec Types in Preference Order

The example for specifying the audio codec is shown from Figure 4-102 below:



(Figure 4-102) Menu >> AV Setup



(Figure 4-103) AV Setup >> Audio Codec

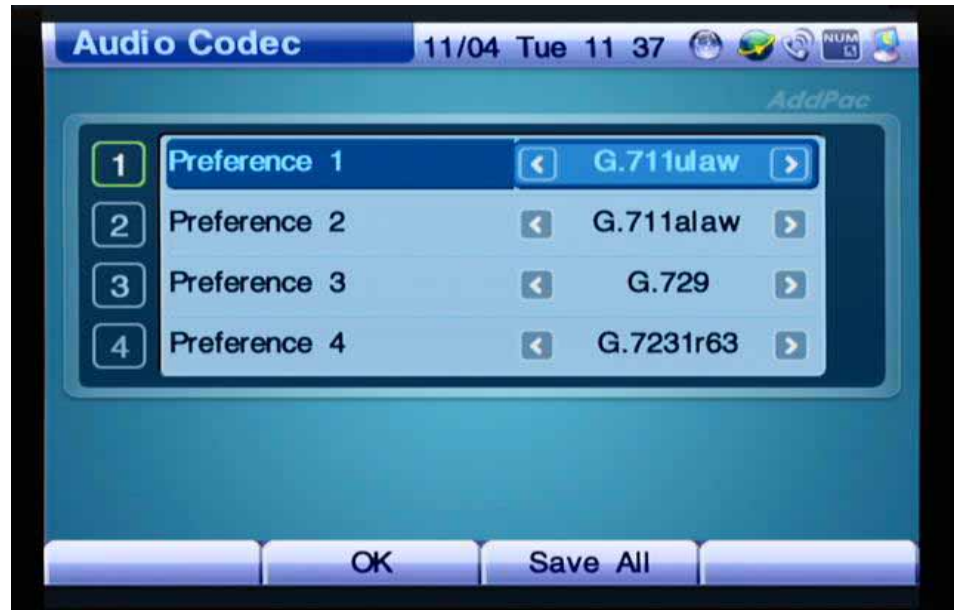
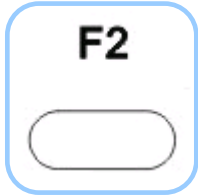

(Figure 4-104) Changing the Preference Order of the Codec

AV Setup - Video Codec

Video Codec is the menu which determines a video codec type to be used for a video call. The AP-VP120 supports MPEG-4, H.264 and H.263. The video quality of MPEG-4 tends to be better than H.263. H.263 has the resolution of QCIF and CIF, MPEG-4 has QVGA, HalfVGA and VGA. The user may make one's selection of Video Codec, Image Size or Frame Rate.



(Figure 4-105) Video Codec Menu Details

[Table 4-16] Description of Video Codec Menu Details

Menu Detail	Description						
Frame Rate	Determines the frame rate per second. The frame rate is most sensitive before the human eyes. You may not see much difference for 30 frame rate per second, but any rate lower than this rate may cause some distortions on the video and the user may feel some discomfort for watching the video. The rate ranges from 3fps to 30fps (by 3 multiples).						
Codec	<p>Selecting a video codec type depends on the user's preference under a given environment. The user may select an appropriate video codec by one's preference over a given environment and video quality.</p> <p>The available codec types are MPEG-4, H.263 and H.264. Among these codec types, select 1 for the codec type with the user's highest preference. If the user does not use this codec type, select None. If 2 and 3 does not have any codec setting, only one single codec type is used.</p>						
Image Size	Determines a size of image to be transmitted to the other party. As the resolution gets higher for more definition, more the bandwidth is required.						
	<table border="1"> <tbody> <tr> <td>H.263</td> <td>QCIF(176x144, CIF(352x288</td> </tr> <tr> <td>MPEG-4</td> <td>QVGA(320x240, HalfVGA(640x240, VGA(640x480</td> </tr> <tr> <td>H.264</td> <td>QVGA(320x240, HalfVGA(640x240, VGA(640x480</td> </tr> </tbody> </table>	H.263	QCIF(176x144, CIF(352x288	MPEG-4	QVGA(320x240, HalfVGA(640x240, VGA(640x480	H.264	QVGA(320x240, HalfVGA(640x240, VGA(640x480
H.263	QCIF(176x144, CIF(352x288						
MPEG-4	QVGA(320x240, HalfVGA(640x240, VGA(640x480						
H.264	QVGA(320x240, HalfVGA(640x240, VGA(640x480						

The example for selecting a video codec type is shown by the following figures:



(Figure 4-106) Menu >> AV Setup



(Figure 4-107) AV Setup >> Video Codec

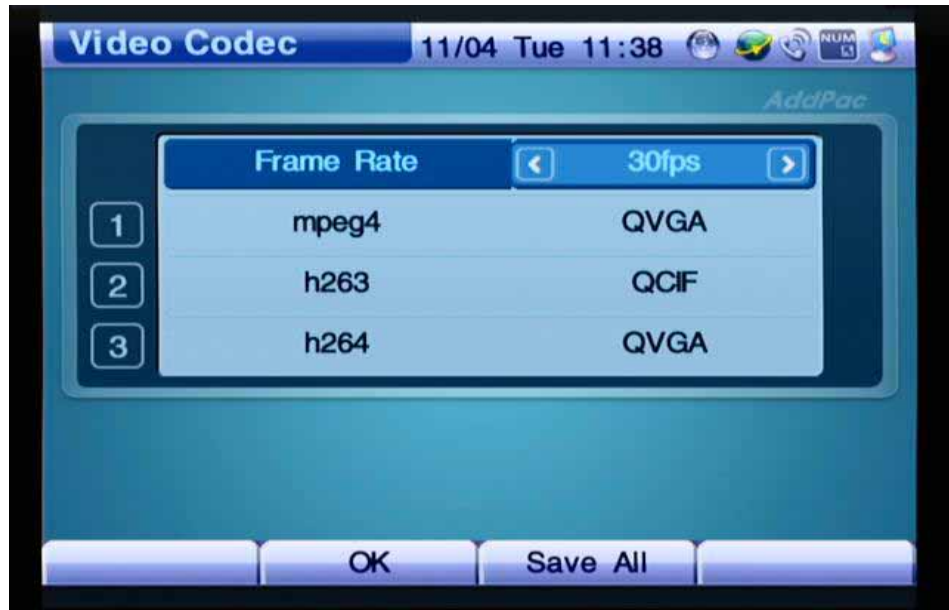

(Figure 4-108) Specifying Frame Rate



(Figure 4-109) Selecting the first option of Video Codec to mpeg4

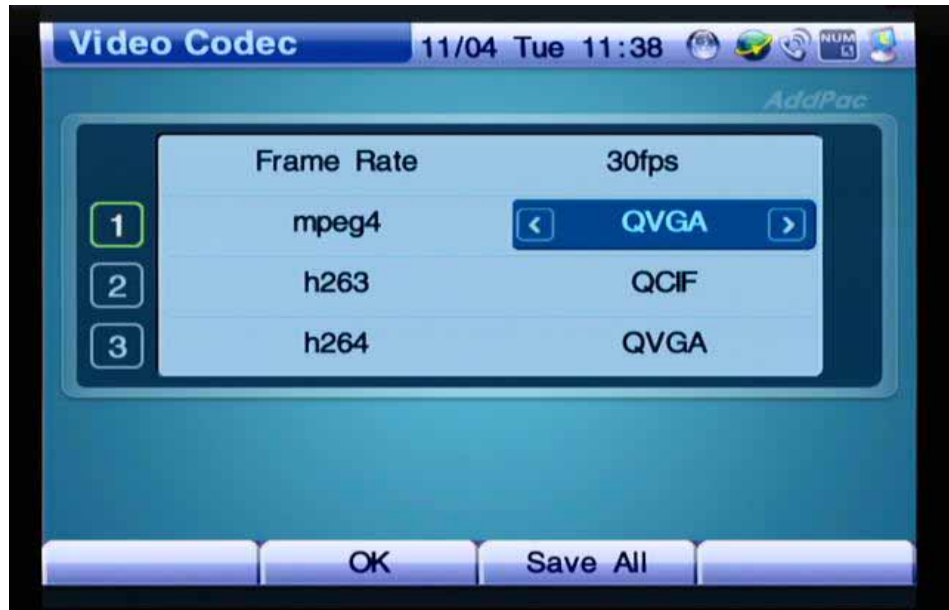

(Figure 4-110) Specifying the Image Size for the First Option of mpeg4

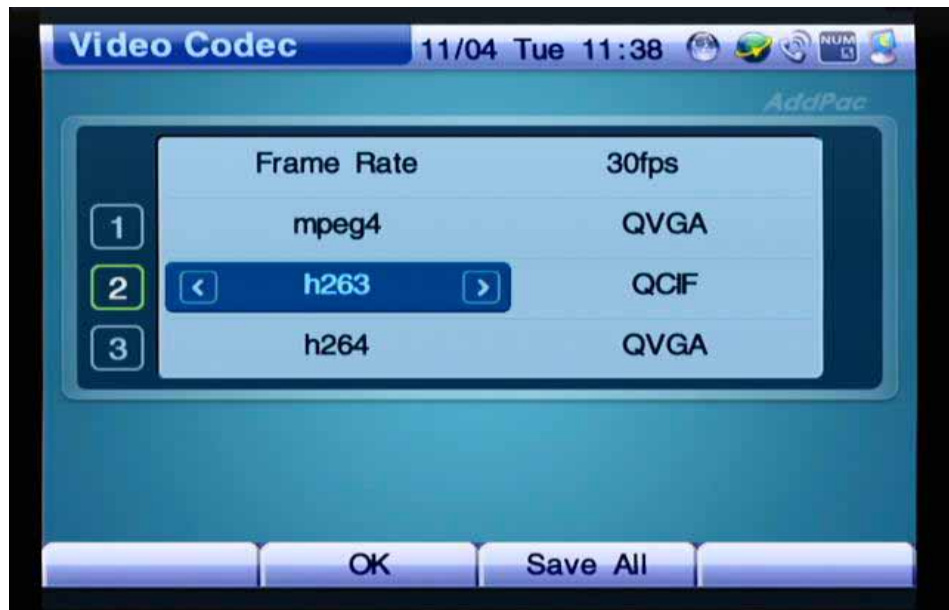

(Figure 4-111) Specifying the Second Option of Video Codec Option to h263

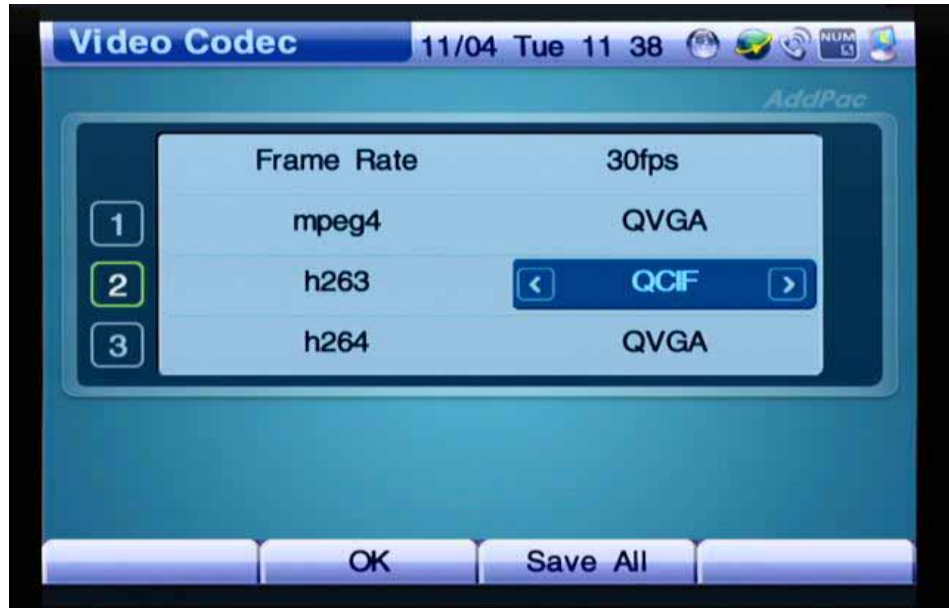

(Figure 4-112) Selecting the option for the Image Size of the Second Menu Detail



(Figure 4-113) Selecting the Option for the Video Codec of the Third Menu Detail

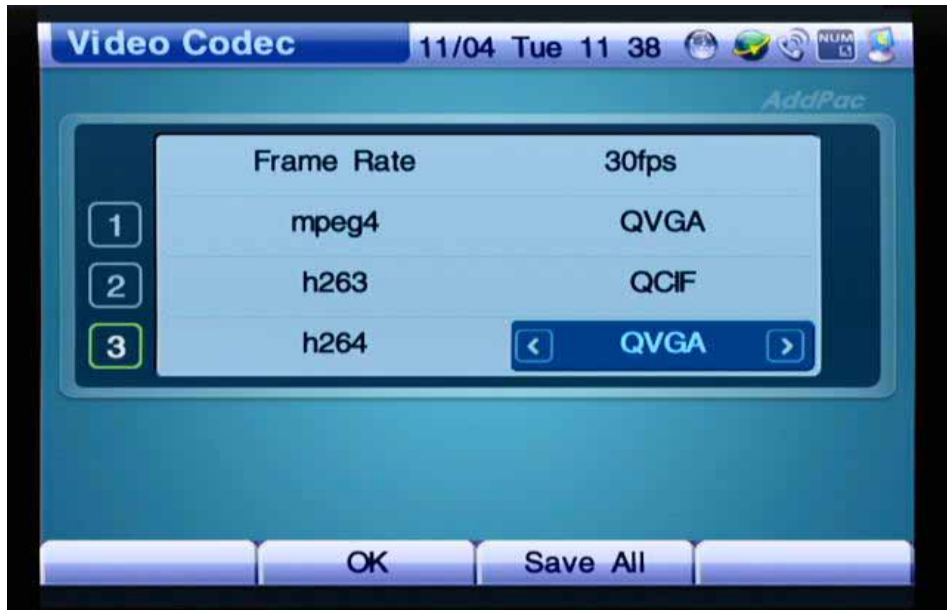
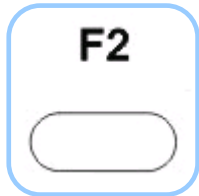

(Figure 4-114) Selecting the Option for the Image Size of the Third Menu Detail

AV Setup - Bandwidth

This menu section determines a range of bandwidth to be used for a video call.



(Figure 4-115) Bandwidth Menu Section

[Table 4-17] Description of Bandwidth Menu Details

Menu Detail	Description
Bandwidth	Changes a range of bandwidth setting
Detail	Changes a bandwidth setting by a unit of 64kbps

The example for specifying video bandwidth is shown in the following figures:



(Figure 4-116) Menu >> AV Setup



(Figure 4-117) AV Setup >> Bandwidth

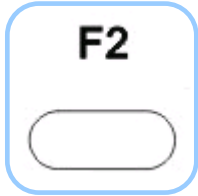

(Figure 4-118) Specifying the Detail option to 1024Kbps and then press F2 to save

AV Setup - Camera

Camera menu section configures or changes the settings of both local and remote cameras. During a video call, the can change the setting of Pan/Tilt.



(Figure 4-119) Screen Layout of Camera Menu Section

The example for configuring the settings of Camera Control by using the keypad is presented from Figure 4-120.



(Figure 4-120) Menu >> AV Setup



(Figure 4-121) AV Setup >> Camera



(Figure 4-122) Selecting Camera Control



(Figure 4-123) Screen Layout of Camera Control Menu Detail



(Figure 4-124) Setting Pan/Tilt/Zoom Menu Option









Network & Call Menu

Network & Call menu is composed of WAN, LAN Interface Setup, SIP/H.323 Signaling, FTP, QoS and other call options. You should know this menu thoroughly to use AP-VP120. This is a very important menu to optimize the settings of the configuration.



(Figure 4-125) Network & Call Menu Category

[Table 4-18] Description for Composition of Network & Call Menu Sections

Menu Section	Description
	<p>This menu configures the settings for WAN interface. Depending on the user's network environment, select DHCP, Static IP Address or PPPoE.</p>
	<p>This menu configures the settings for LAN interface with a router or bridge.</p>
	<p>This menu displays the present network status.</p>
	<p>Has SIP/H.323 Protocol for using SIP Server or the gatekeeper to make a call and controls other protocol information and QoS.</p>
	<p>Configures the setting for Call Forward, DND, Call Waiting and Auto-Answering.</p>
	<p>Assigns a caller's number to an outbound call when the AP-VP120 has more than one number</p>
	<p>Enables or disables FTP, HTTP, TELNET, SNMP and changes TCP/ UDP port number</p>
	<p>Accesses to a particular server automatically and periodically and compares OS and Configuration versions of itself and then determines downloading</p>
	<p>Configures the settings of Smart Service Control Protocol (SSCP based operation, which is the AddPac proprietary protocol which communicates between the AddPac IPNext PBX and AP-VP120</p>

Network & Call - Internet Setup

Internet Setup menu has the setting options of WAN interface. The user needs to adjust the settings on this menu to be adaptive to one's environment because the network environment can be diversified. The supporting WAN protocols are DHCP, Static IP, PPPoE, static IPv6 and IPv6 EUI-64, IPv6 auto-config and IPv6 None.



(Figure 4-126) Internet Setup Menu Detail

[Table 4-19] Description of Internet Setup Menu Details

Menu Detail	Description
DHCP(Dynamic IP)	The representative applications for using the dynamic IP of this WAN protocol the cable, VDSL and IP-ADSL modems.
Static(Fixed IP)	Configures the WAN Interface by fixing the IP address manually. The representative applications are ADSL(My IP, E1/T1 leased line).
PPPoE(Dynamic IP)	This WAN protocol takes the dynamic IP address from a PPP server. The representative application is ADSL.
IPv6	Takes the entry of IPv6 address. Set up either Static, EUI-64 or Auto Configuration, which ever is suitable to the settings
VLan	The networks connected to each other physically, but separated logically different to each other, divides the broadcasting regions

The following figures exhibit the method for selecting the DHCP menu option which commonly used for the cable modem settings:



(Figure 4-127) Menu >> Network & Call >> Internet



(Figure 4-128) Select DHCP then press OK

Figure 4-129 shows the method for selecting the static IP menu option.



(Figure 4-129) Menu >> Network & Call



(Figure 4-130) Network & Call >> Internet Setup

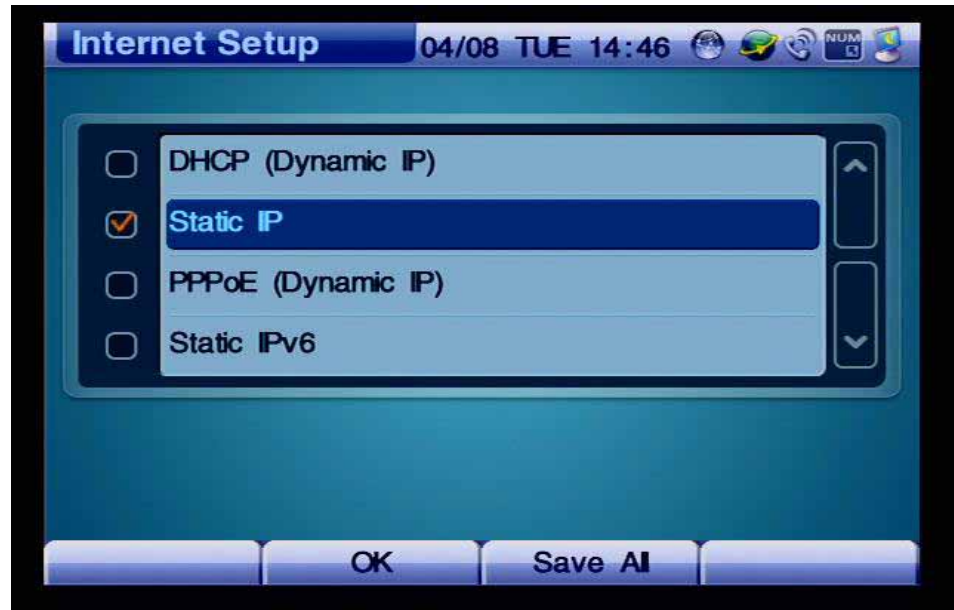

(Figure 4-131) Select Static IP

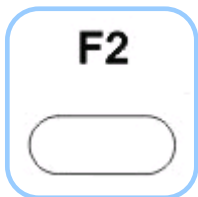

(Figure 4-132) Enter the IP Address of "172.17.201.232"

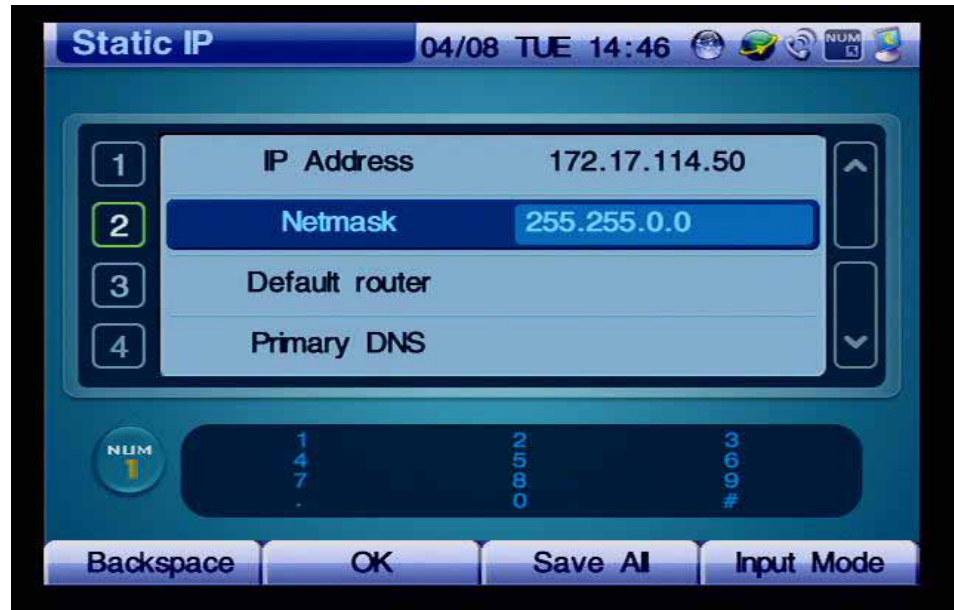

(Figure 4-133) Enter the Netmask of "255.255.0.0"

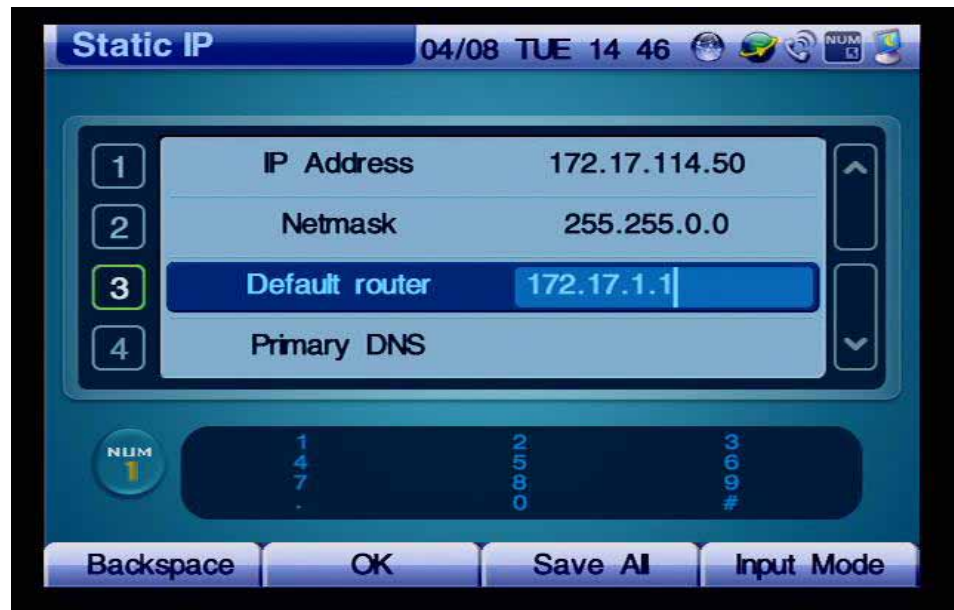

(Figure 4-134) Enter the Default router of '172.17.1.1'



(Figure 4-135) Enter the Primary DNS of '168.126.63.1'

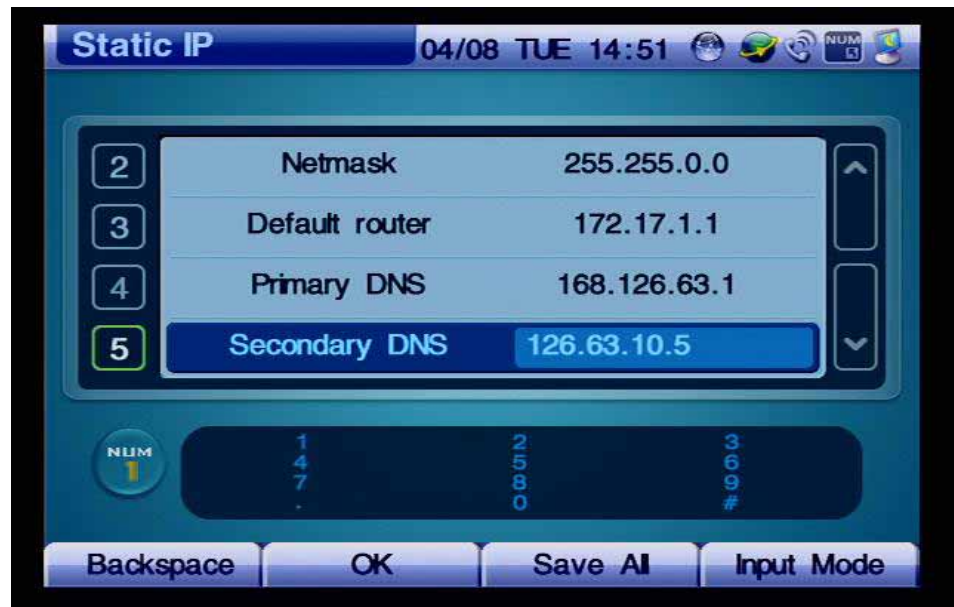

(Figure 4-136) Enter the Secondary DNS of '126.63.10.5' (optional)

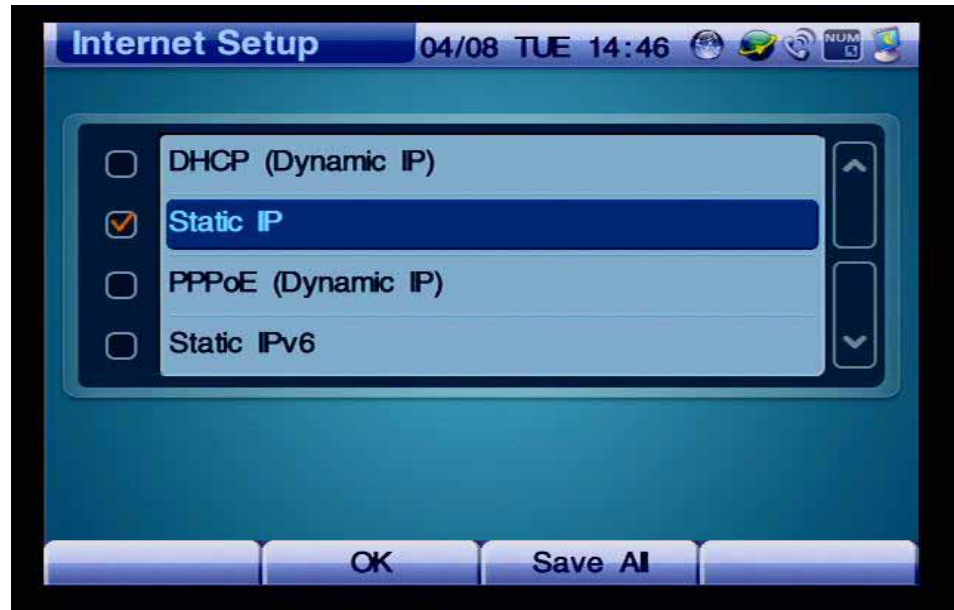
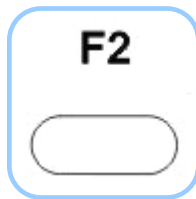

(Figure 4-137) Pressing OK and then Moving to the Upper Menu

The following figures show the method of selecting PPPoE which is used for the application of ADSL:



(Figure 4-138) Menu >> Network & Call



(Figure 4-139) Network & Call >> Internet

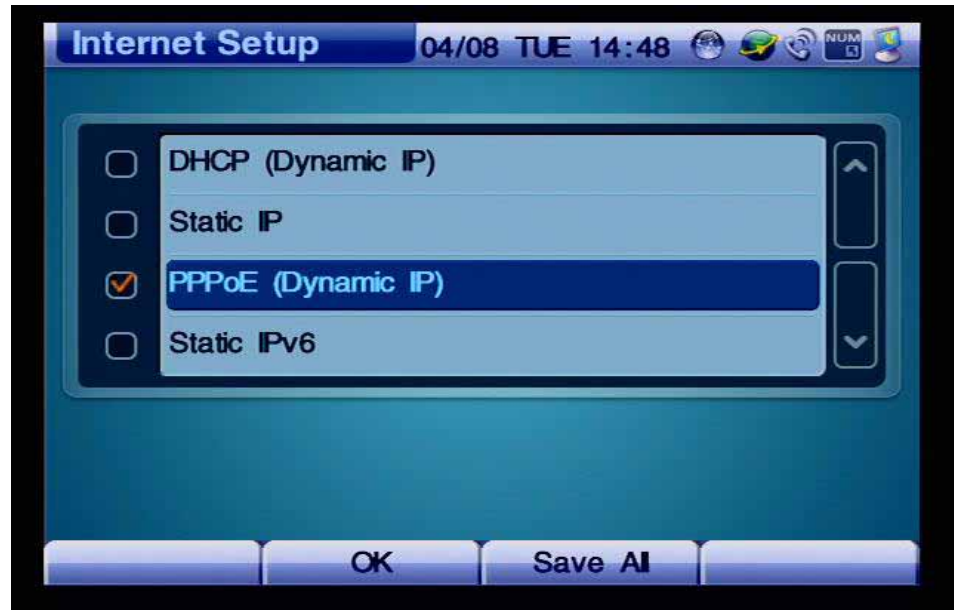

(Figure 4-140) Selecting the Option for PPPoE



(Figure 4-141) Selecting the Option for PPPoE Authentication Method

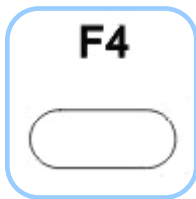

(Figure 4-142) Enter 'Addpac' for the User Name



(Figure 4-143) Enter 'addpac' for the user password

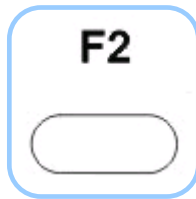

(Figure 4-144) Pressing OK and then Moving to the Upper Menu

The method for selecting the Static IPv6 is shown from Figure 4-145.



(Figure 4-145) Menu >> Network & Call



(Figure 4-146) Network & Call >> Internet Setup

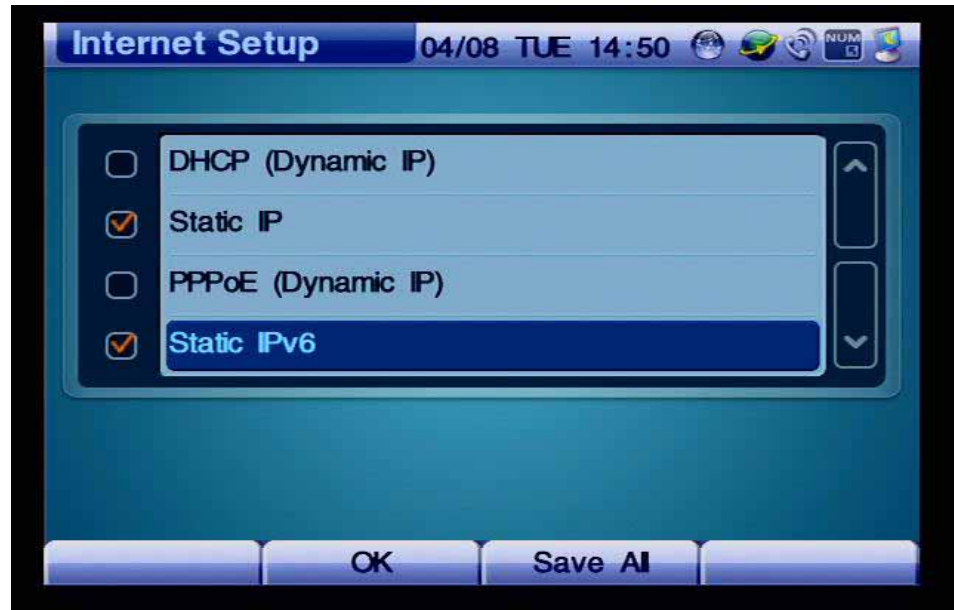

(Figure 4-147) Selecting the Option for Static IPv6

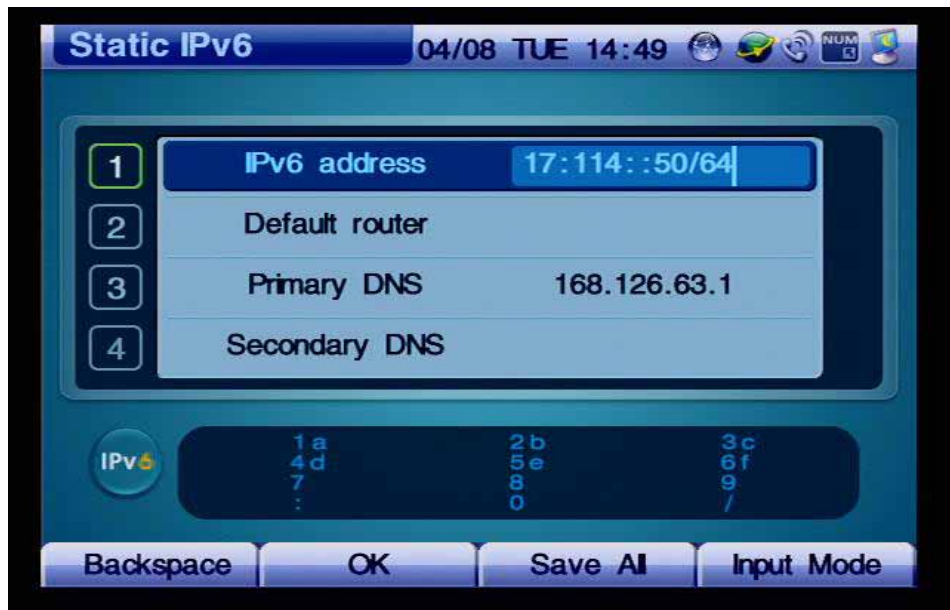
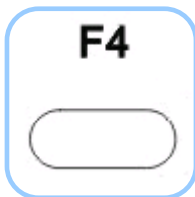

(Figure 4-148) Entering IPv6 address of '2001:e78:b01:17:10::60/64'

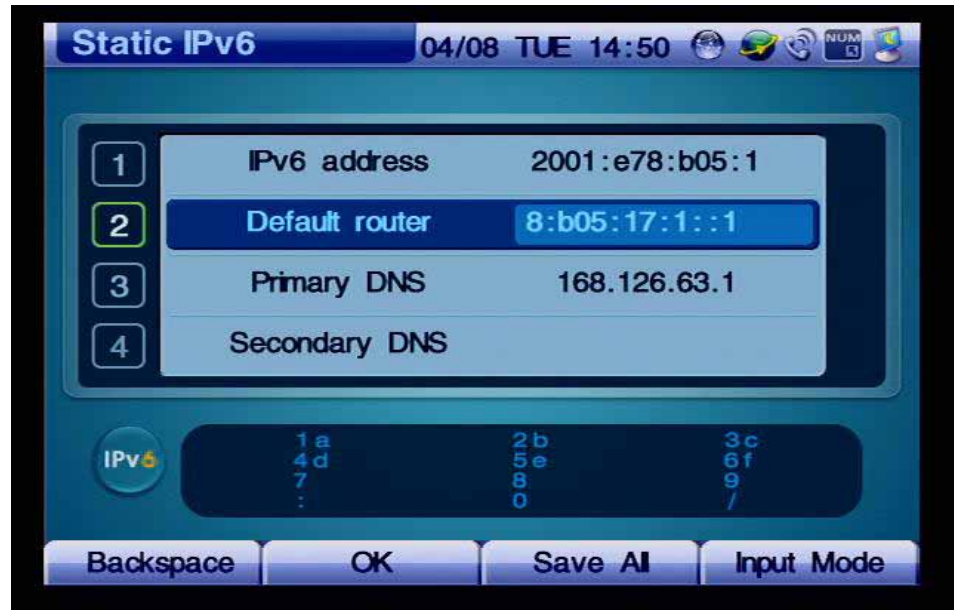

(Figure 4-149) Entering the Default router address of '2001:e78:b01:17:1::1'

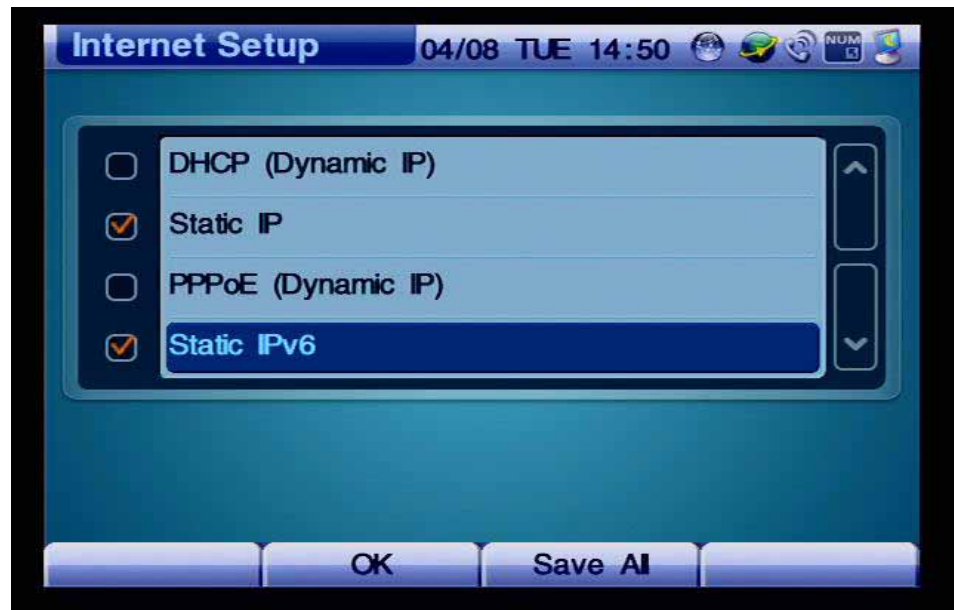
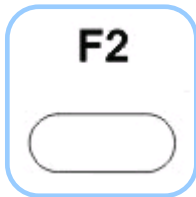

(Figure 4-150) Press OK then the screen moves to the upper menu category category

The following figures present the example of configuring the settings for VLAN.



(Figure 4-151) Menu >> Network & Call



(Figure 4-152) Network & Call >> Internet Setup



(Figure 4-153) Selecting the Option for VLAN Setup

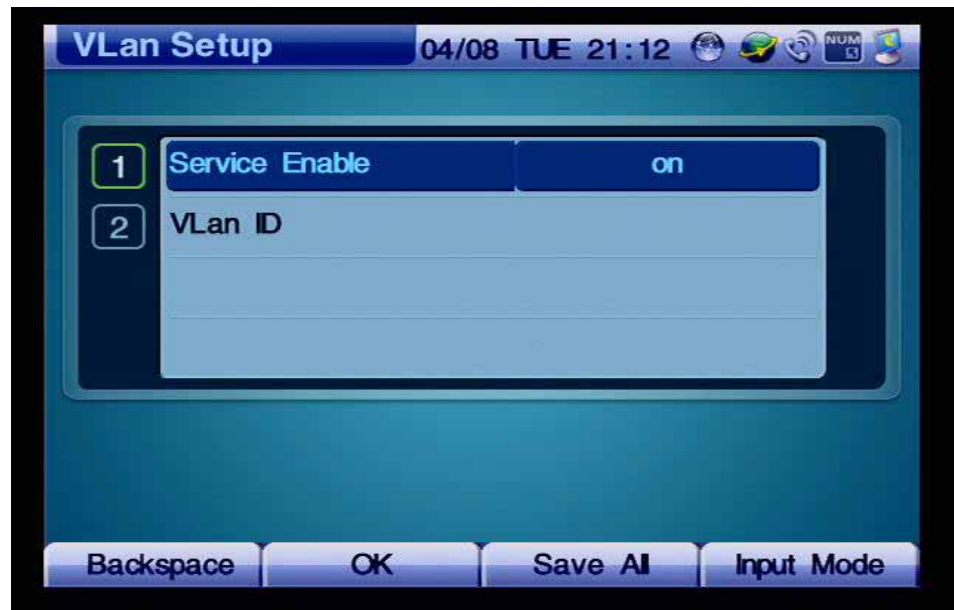

(Figure 4-154) Selecting the Option for Enabling or Disabling VLAN

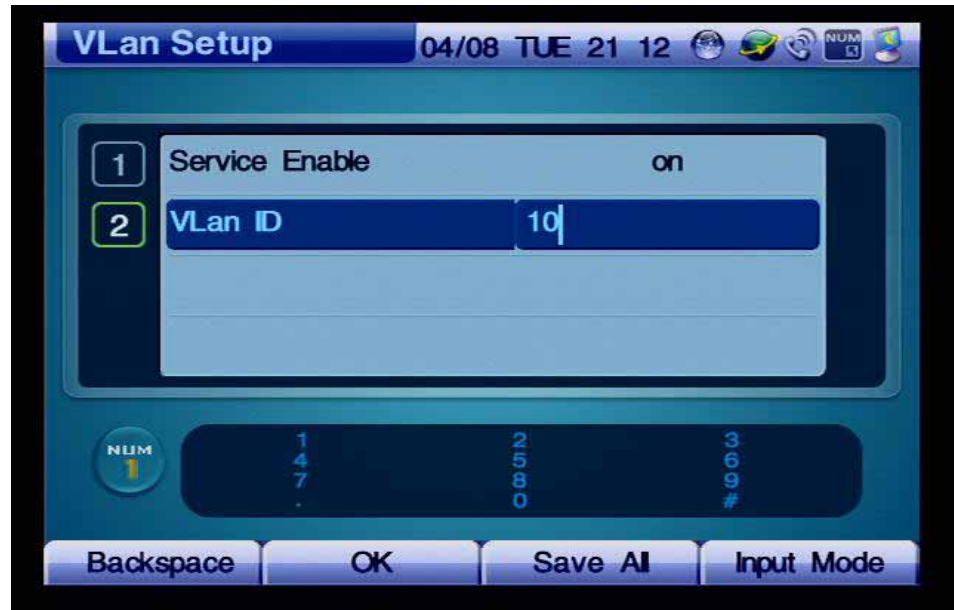

(Figure 4-155) Entering '10' for VLAN ID

Network & Call - LAN Setup

LAN Setup Menu determines a use for the LAN1 interface of the AP-VP120. This menu connects the LAN1 to the PC or hub, the available options are None, DHCP for 1PC, DHCP for Several PCs and bridge. 'DHCP for 1PC shares the same IP address with the PC connected to the LAN1 with the AP-VP120. DHCP for Several PC has a function of router, which is used for connecting more 2 PCs.

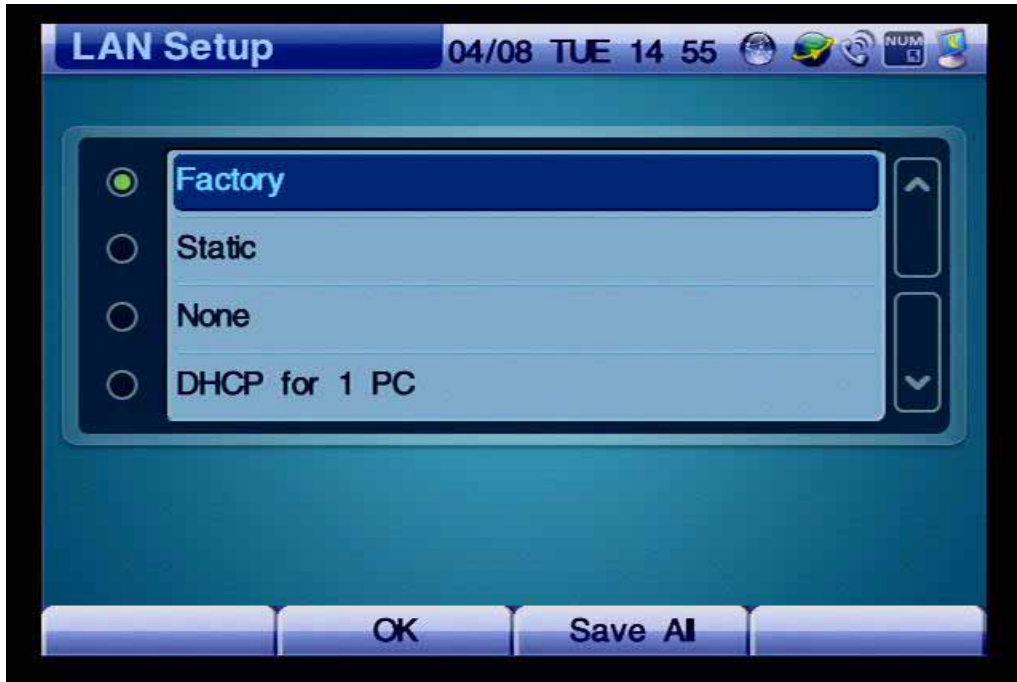

(Figure 4-156) LAN Setup Menu Section

[Table 4-20] Description of LAN Setup Menu Details

Menu Detail	Description
Factory	Sets to the factory default mode. (192.168.10.1 is set at default)
Static	This mode allows the user to configure the LAN setting directly.
None	This option disables the LAN settings
DHCP for 1 PC	DHCP for Several PCs and bridge. 'DHCP for 1PC shares the same IP address with the PC connected to the LAN1 with the AP-VP120.
DHCP for Several PCs	Has a function of router, which is used for connecting more 2 PCs
Bridge	Configures the LAN setting to the bridge mode



(Figure 4-157) Menu >> Network & Call >> LAN Setup

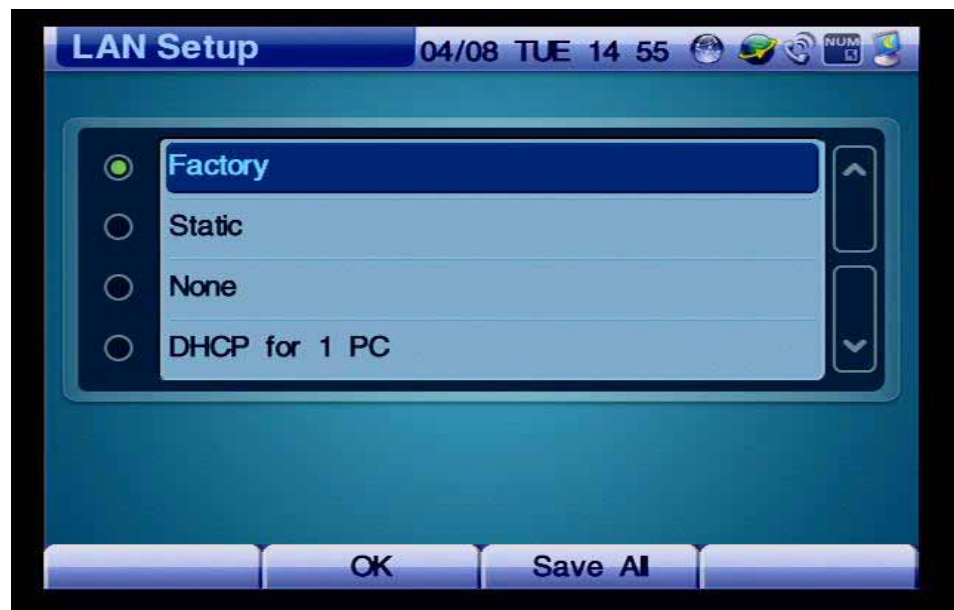

(Figure 4-158) LAN Setup Menu Options

Network & Call - Network Status

This menu displays 11 details of network status for protocols, Ethernet ports, IP, DNS, GK (H.323) and SIP Proxy Server at a glance.

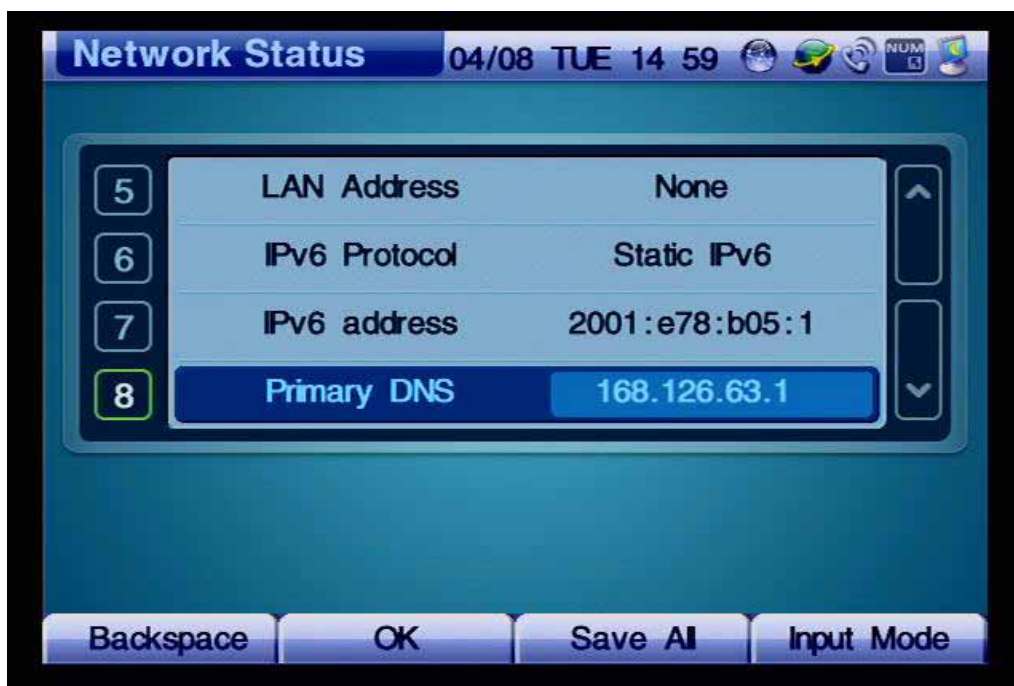

(Figure 4-159) Network Status Menu Section

[Table 4-21] Description of Network Status Menu Details

Menu Detail	Description
WAN Link	Indicates link up/down status of LAN0 interface
LAN Link	Indicates link up/down status of LAN1 (PC) interface
WAN Protocol	Indicates WAN IPv4 protocol(DHCP, Static IPv4, PPPoE)
WAN Address	Displays WAN IPv4 address
LAN Address	Displays LAN IPv4 address
IPv6 Protocol	Displays WAN IPv6 protocol
IPv6 Address	Displays WAN IPv6 address
Primary DNS	Displays the Primary Domain Name Server
Secondary DNS	Displays the Secondary Domain Name Server
Status of GK [H.323]	Indicates the registration status of gatekeeper
Status of SIP Proxy	Indicates the registration status of SIP Proxy server



(Figure 4-160) Menu >> Network & Call >> Status

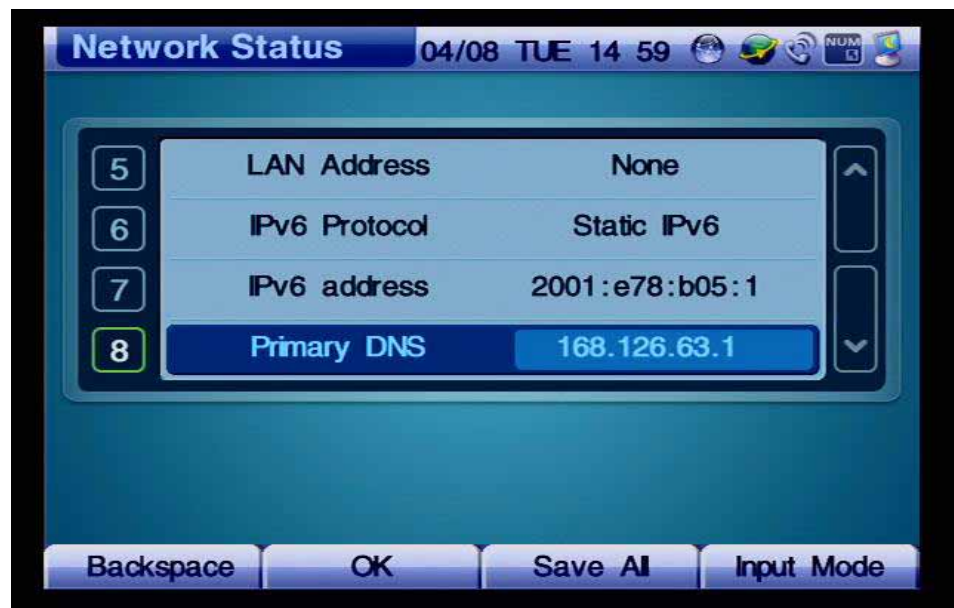
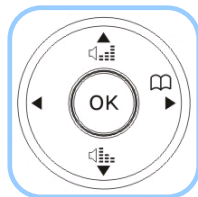

(Figure 4-161) Network Status Menu Details

Network & Call - VoIP Setup

VoIP Setup menu is used for interoperating with SIP Server or gatekeeper or making adjustment of E.164 and QoS on SIP and H.323 basis.



(Figure 4-162) VoIP Setup Menu Details

- Signaling Setup



(Figure 4-163) Menu >> Network & Call >> VoIP Setup

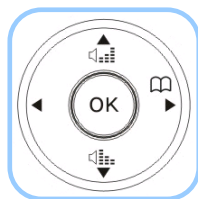

(Figure 4-164) VoIP Setup Menu Details



(Figure 4-165) Signaling Setup Menu Options

Figure 4-179 shows the setting details after you select SIP Protocol.



(Figure 4-166) SIP Protocol Menu Options

[Table 4-22] Description of SIP Protocol Menu Options

Option	Description
User Name	For registration to SIP server
Password	For registration to SIP server
Primary Server	Enter an IP address or a domain of the primary SIP sever
Secondary Server	Enter an IP address or a domain of the secondary SIP sever
Phone Number	Enter the user's E.164 Number
e.164 Registration	Register E.164 number

The following figures present an example for entering the setting values for internetworking with SIP server:



(Figure 4-167) Entering SIP User Name



(Figure 4-168) Entering SIP User Password

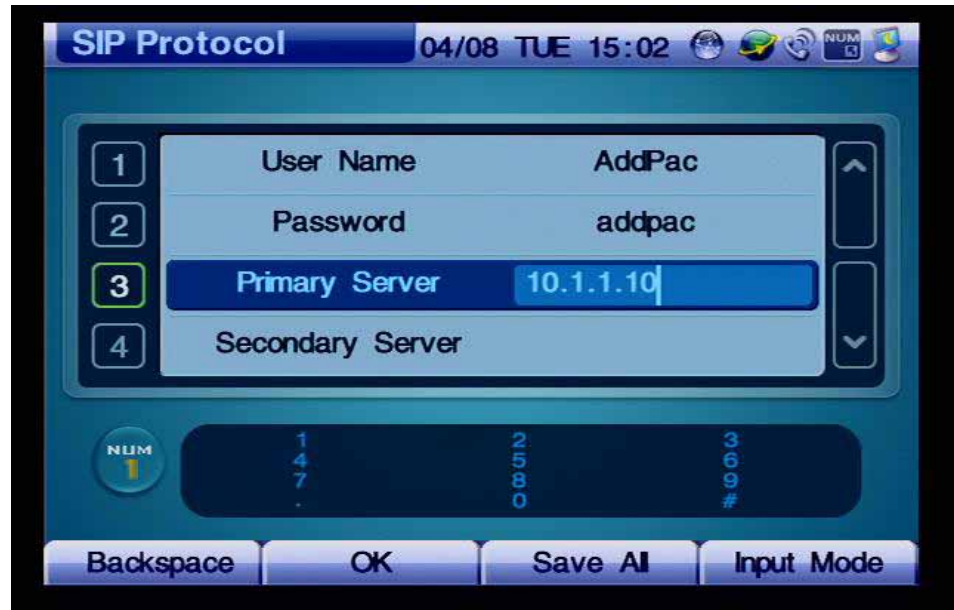

(Figure 4-169) Enter the IP address of SIP Primary Server



(Figure 4-170) Select the option for setting 'Register E.164' to 'On' and press F2 to save and then enter Phone Number

The following exhibits the screen after H.323 is selected.



(Figure 4-171) H.323 Protocol Menu Details

[Table 4-23] Description of H.323 Protocol Menu Details

Item	Description
H.323 ID	Enter H.323 ID for a gatekeeper registration
H.323 Password	Enter a password for authentication when to register the gatekeeper
Primary GK	Enter an IP address of the primary gatekeeper to be used first
Secondary GK	Enter an IP address of the secondary gatekeeper
Phone number	Enter the user's e.164 number
Register GK	Register a gatekeeper

The following figures show the example for entering the setting values for internetworking with a gatekeeper.



(Figure 4-172) Entering H.323 ID



(Figure 4-173) Entering the Password for Registering the Gatekeeper

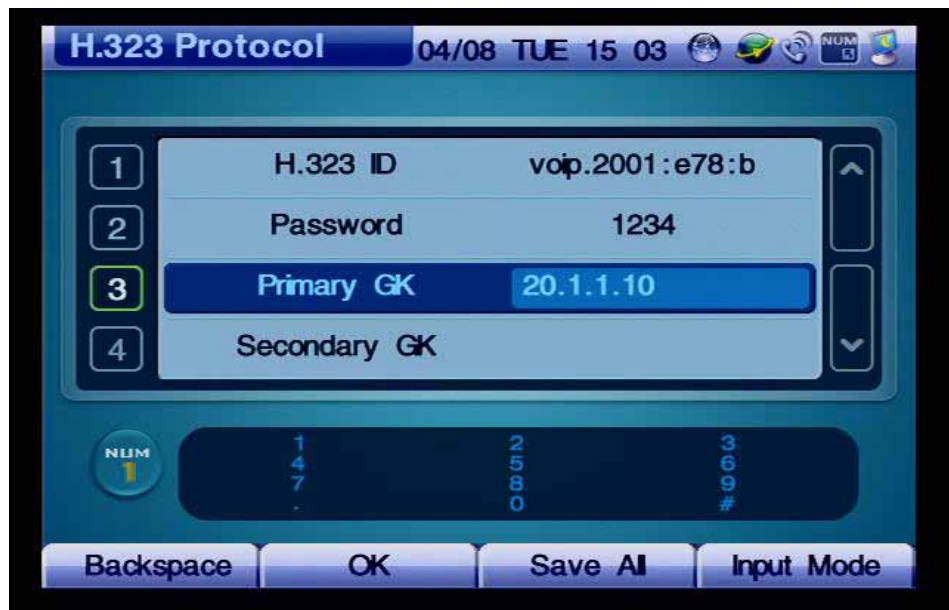

(Figure 4-174) Entering the IP address of the Primary Gatekeeper.

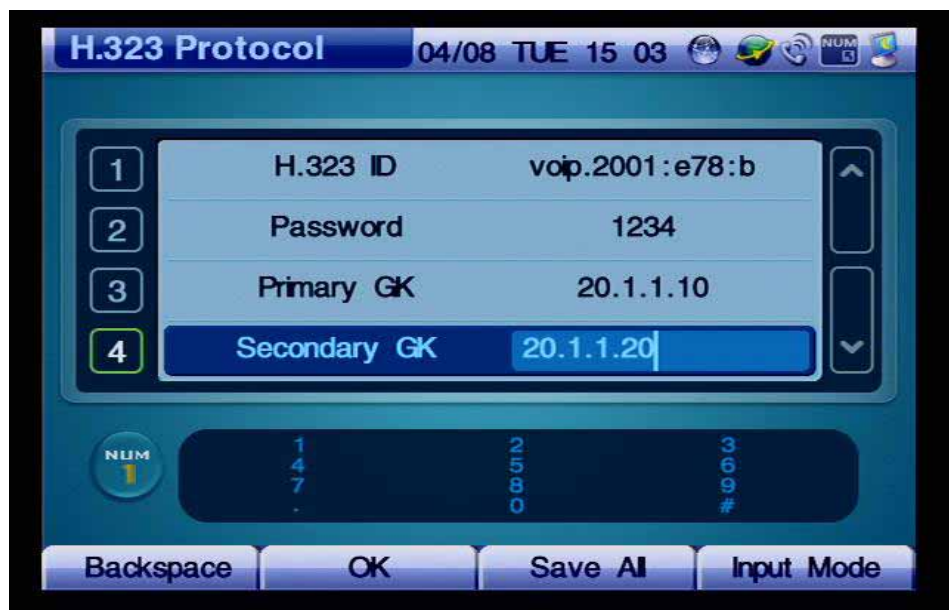

(Figure 4-175) Entering the IP Address of the Secondary Gatekeeper



(Figure 4-176) Entering E.164 phone number

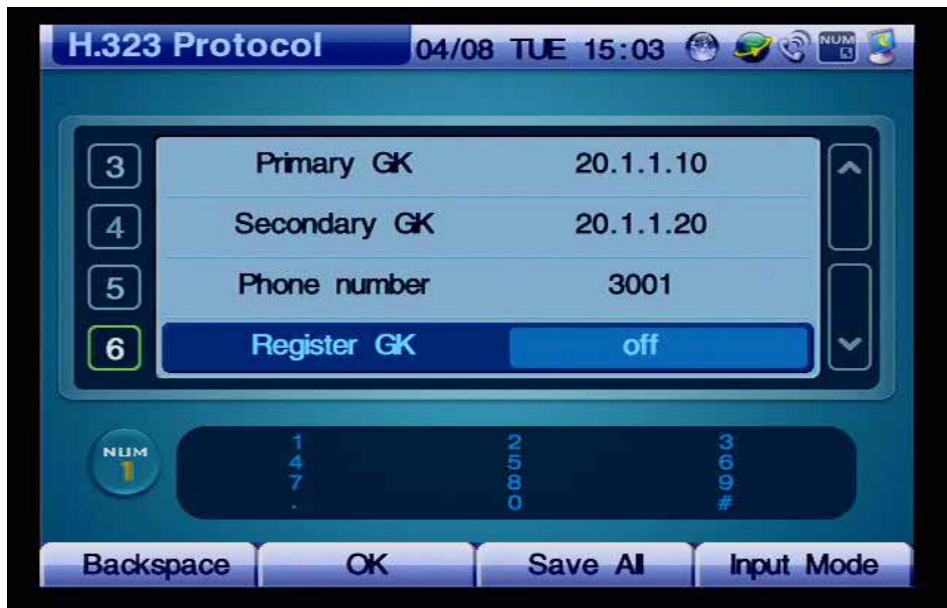

(Figure 4-177) Selecting the Option for Registering the Gatekeeper then Pressing F2 to Save

- QoS (Quality of Service)

The AP-VP120 Video Phone transmits the video compression format of MPEG-4 or H.263 and the voice compression format of VoIP. A high video quality video stream such as MPEG-4 is affected very largely by a network status. Thus, when the network is not in a good condition, the video transmission to the other party can be problematic.

QoS limits transmitting the video and voice packet under the guaranteed bandwidth. The user should calculate the required bandwidth for the video codec and voice packet and then apply that bandwidth to QoS.



(Figure 4-178) QoS Menu Options

[Table 4-24] Description of QoS Menu Options

Option	Description
QoS Disable	Disables QoS
QoS Enable	Enbles QoS
QoS Control with Bandwidth	This setting is for WAN interface and ranges from 48Kbps to 4Mbps

This QoS feature is applied to the WAN interface and does not apply to the LAN. The setting ranges from 48Kbps to 4Mbps. Enter the summation of the bandwidths for the video codec and voice packet.

For example, the bandwidth of MPEG4/QVGA requires 512Kbps. If G.711 is voice codec, the total bandwidth required for the WAN interface is 600Kbps, then enter '600'.



(Figure 4-179) Menu >> Network & Call >> VoIP Setup



(Figure 4-180) Selecting QoS

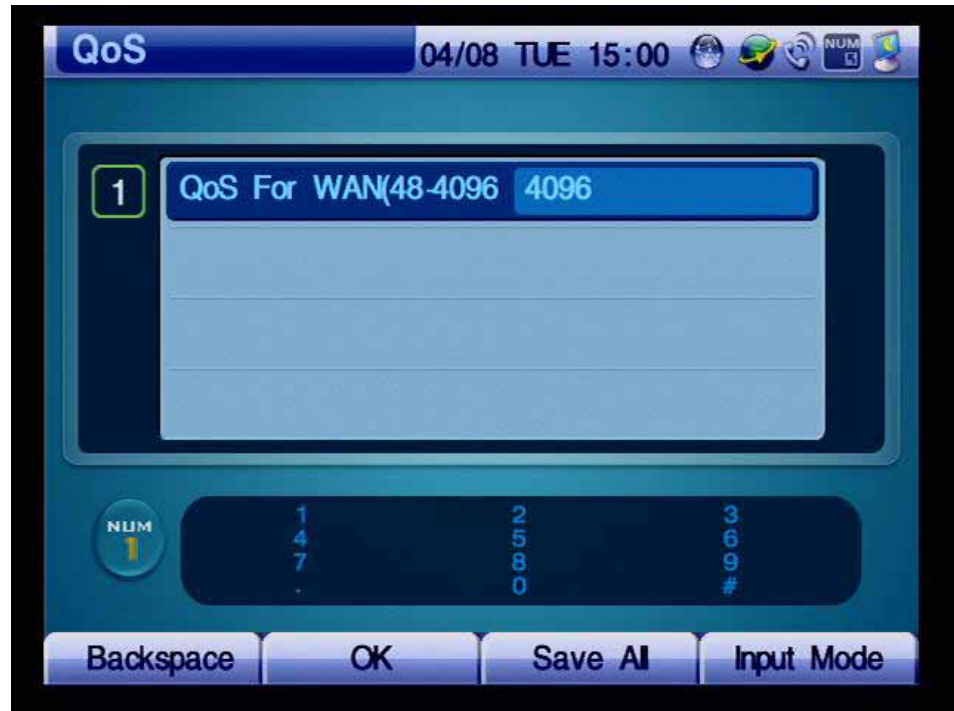
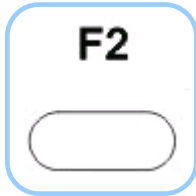

(Figure 4-181) QoS Menu Options

- SIP Options

This SIP Options correspond to the numerous supplementary features and options for SIP and H.323 protocols. These options are continually updated through APOS upgrade.



(Figure 4-182) SIP Menu Options

[Table 4-25] Description of SIP Menu Options

Menu Option	Description
Call transfer mode	Choose an option to determine the call-transfer-mode. The available options basic and attend.
Confer. Service Tag	Enter a VoIP tag for a conference
Confer. Service Name	Specify a name for conference service
Enable ping	For using the AP-VP120 in the NAT/Firewall configuration, enter a Firewall address to verify the actual public IP
Media Channel	Transmit a RTP Session to listen to the inband ringbacktone of PSTN in NAT/Firewall network configuration
Min se	Specify a setting for session timer
Retry Count	Assigns SIP UA retry count to the transmission count of SIP INVITE If the trying message for the INVITE does not come in a specified time due to a network failure, the AP-VP120 sends the next INVITE message. 10 is set at default and the general setting is 3.
The Other Party ID	When the user-name is not numeric, but textual, it is applied within the message.
Secondary Path	This is applied when the inbound call number is not numeric but textual.
Domain Setup	Transmit From/To field to SIP message to a specified domain instead of an IP address.
Signaling Port	5060 is set at default and this option is used to make a change
SIP Server	Choose an option to set SIP Server

- PSTN Prefix

This option specifies a set of numbers for accessing FXO (a call try through PSTN) and not used for a call accessing VoIP network. This option is useful for transferring a call to PSTN when VoIP communication in abnormal state caused by some exceptional cases, such as a network failure, the call can not be delivered.



(Figure 4-183) PSTN Prefix Menu Option

[Table 4-26] Description of PSTN Prefix Menu Option

Item	Description
Number Input	Specify a set of number for FXO access. In off-hook condition, the setting occupies FXO.

Network & Call - Additional Service

Additional Service menu includes the configuration settings of Call Forward, DoNotDisturb, Call Wait Setup, Auto Response.

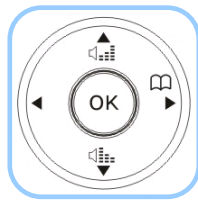

(Figure 4-184) Menu >> Network & Call >> Add. Service



(Figure 4-185) Additional Service Menu Details

- Call Forward

Call Forward menu configures the settings for forwarding an inbound call to the other number or voice mail when the phone user is busy on the line or not able to answer a call or need to forward a call unconditionally. The Call Forward has the 2 setting options for forwarding a call to a specific number or voice message. In case the Call Forward is set to the both, the call is forwarded to voice message.



(Figure 4-186) Call Forward Menu Section



(Figure 4-187) Forward Setup Menu Details

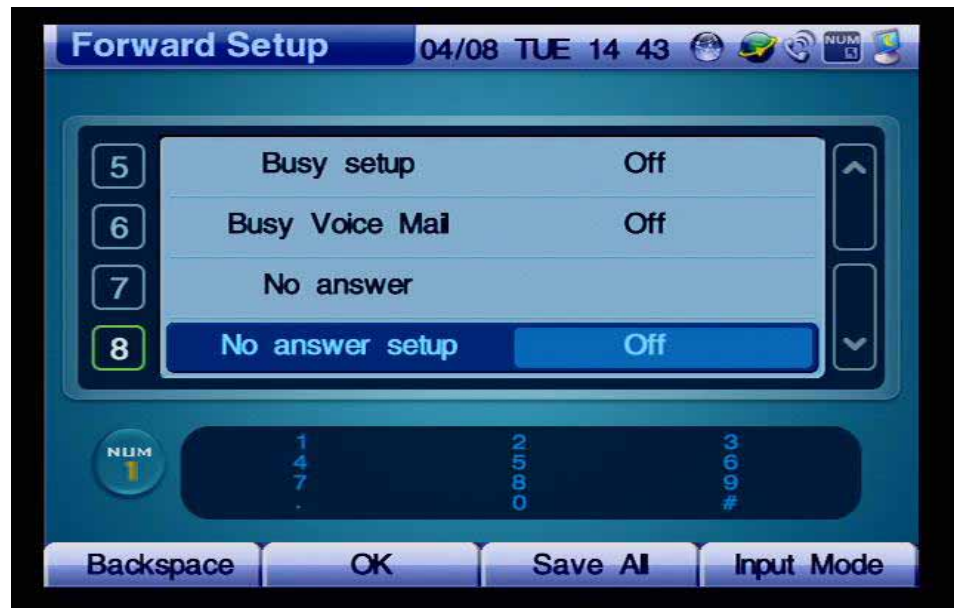

(Figure 4-188) Forward Setup Menu Details

[Table 4-27] Description of Call Forward Menu Options

Menu Option	Description
Unconditional	Enter a phone number to which all calls to be forwarded
Unconditional Setup	Select an option for enabling or disabling unconditional call forwarding (Default: Disabled)
Unconditional voice mail	Select an option for unconditional call forwarding to voice mail (Default: Disabled)
Busy	Enter a phone number to which a call to be forwarded if busy
Busy Setup	Select an option for enabling or disabling call forwarding if busy (Default: Disable)
Busy Voice Mail	Select an option for enabling/ disabling call forwarding if busy (Default : Disable)
No Answer	Enter a phone number to which a call to be forwarded if not answered
No Answer Setup	Select an option for enabling or disabling call forwarding if not answered (Default: Disable)
No Answer Voice Mail	Select an option for enabling or disabling call forward if not answered (Default : Disable)

- DND (DoNotDisturb)

This feature prevents calls from ringing on an extension (Ring Silence) or activates Call Reject (rejects an incoming call which is placed on Ring Silence) which can be enabled if Absence button pressed for more than 2 seconds DoNotDisturb (DND) is enabled (if it is already enabled, it becomes disabled afterwards). Call Reject is activated only by Smart Service Control Protocol (SSCP) interoperating with the AddPac Next PBX.



(Figure 4-189) Additional Service Menu Details



(Figure 4-190) DoNotDisturb Menu Options

[Table 4-28] Description of DND Menu Options

Option	Description
Call Reject	Rejects the calls sent from a calling party
Ring Silence	Prevents the calls from ringing which is sent from a calling party

- Call Wait Setup

This feature alerts the phone user to incoming call while the phone user is on another call. Call Waiting provides an audio alert and displays incoming information (visual alert) on the phone screen. While the phone user is busy on the line, any incoming call can be placed on hold. When the user ends the call, the call being placed on hold can be answered. The following figure shows the Call Waiting options (supported by SSCP) for the busy line.



(Figure 4-191) Additional Service Menu Details



(Figure 4-192) Call Wait Menu Options

[Table 4-29] Description of Call Wait Setup Menu Options

Option	Description
Call Wait Off	Disables Call Waiting
Call Wait On	Enables Call Waiting

- Auto Response

Automatic Response menu answers an incoming call automatically, so the phone user does not have to take the call directly. The user may set the time interval to answer the call automatically by 3 seconds, 5 seconds, 10 seconds and 15 seconds.



(Figure 4-193) Additional Service Menu Details

[Table 4-30] Description of Call Wait Setup Menu Options

Menu Option	Description
Direct Response	Connects incoming calls automatically after one ring
After 3 sec.	Connects incoming calls automatically after 3 seconds
After 5 sec.	Connects incoming calls automatically after 5 seconds
After 10 sec	Connects incoming calls automatically after 10 seconds
After 15 sec	Connects incoming calls automatically after 15 seconds
No Auto Response	Disables Auto Response

Network & Call - Multi Phone Number

If your phone is assigned with more than one number, this menu determines which number is to be assigned to outbound calls. The Phone can take inbound calls with many different numbers, but outbound calls can take only the selected number at default.



(Figure 4-194) Multi Phone Number Menu Option

[Table 4-31] Description of Multi Phone Number Menu Option

Multi Number	Description
	This example shows the phone number of 3009 which has been already assigned and selected at default



(Figure 4-195) Menu >> Network & Call >> Multi Number

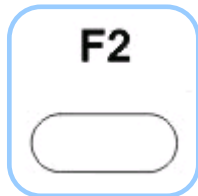
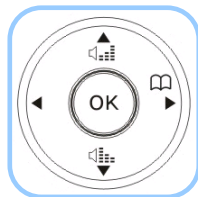

(Figure 4-196) Multi Phone Number Menu Option

Network & Call - Service Port Setup

This menu enables or disables FTP, TELNET, SNMP services and changes the TCP/UDP Port number of the relevant service.



(Figure 4-197) Service Port Setup Menu Details

These settings show a remote device which can access and control AP-VP120 through FTP which is set to the port number of 21, HTTP which is set to the port number of 80 and TFTP which is set to the port number of 69 at default.

The AP-VP120 can perform the role of SNMP Agent. By using SNMP of the remote device, you can access the AP-VP120 and use its SNMP (default: 161).

GUI EZ-Setup Program can be configured by using the console. Also remote configuration is possible by using TCP/IP. If you want to use GUI EZ-Setup Program to configure the video phone from a remote location, check this service option (default: 514).



(Figure 4-198) Menu >> Network & Call >> Service

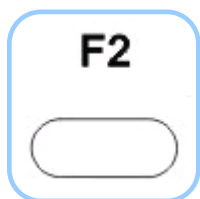

(Figure 4-199) Service Port Setup Menu Details

Network & Call - Auto Upgrade

If a new feature of the AP-VP120 is added, then the software (firmware) needs to be upgraded. One way of upgrading the software is using FTP manually. Another way is to configure the settings of the AP-VP120, so it can access a specific server automatically on periodic basis and compares its existing and configuration version, then upgrade the firmware automatically if the version is different.



(Figure 4-200) Auto-Upgrade Menu Details

[Table 4-32] Description for Composition of Auto Upgrade Menu Details

Menu Details	Description
URL	Enter the URL of Auto Upgrade Server Example: down.addpac.com/apos/VP120/packing.lst
Login Name	Enter the authentication ID for accessing Auto Upgrade Server Example: addpac
Login Password	Enter the authentication password for accessing Auto Upgrade Server Example: addpac
Interval Success (Day)	Set the time interval for retry in case of auto-upgrade success. 30-day is set at default
Interval Retry (Min)	Set the time interval for retry in case of auto-upgrade failure. 30-day is set at default
Server Port	Enter the port number of Auto Upgrade Server. 80 is set at default
Reboot after upgrade	Select the option for rebooting after auto-upgrade Example: On/Off (Press the keypad to change the setting from On to Off or Off to On)



(Figure 4-201) Menu >> Network & Call >> Auto Upgrade



(Figure 4-202) Auto Upgrade Menu

Network & Call - SSCP Setup

Smart Service Control Protocol (SSCP) is the AddPac proprietary protocol operates between the IP Next PBX and IP terminals. SSCP enables the AddPac IP terminal to take the soft key for each of its status from the IPNext PBX and receive a wide range of services from the IPNext PBX. The call features supported by SSCP are Redial, GroupPark, GroupPickup, NewCall, CCBS, Park, Pickup, Transfer, Hold, Add-Party, Conference and more.



(Figure 4-203) SSCP Setup Menu Details

[Table 4-33] Description of SSCP Menu Details

Menu Option	Description
SSCP Setup	Select the option for enabling or disabling SSCP mode
Call-manager 1 ~ 5	Call Manager Server Configuration List: Up to 5 servers can be set. In case of redundancy configuration, Call-Manager 1, 2 are configured



(Figure 4-204) Menu >> Network & Call >> SSCP Setup



(Figure 4-205) SSCP Setup Menu Details





Application Menu

Applications menu is composed of VoD Browser, File Browser, Short Message Service (SMS), Conferencing, Digital Video Recorder (DVR), Voice Mail and Remote Broadcasting Communication. More diversified features of this menu can be supported through the software updates.



(Figure 4-206) Application Menu

[Table 4-34] Composition of Application Menu Categories

Menu Category	Description
	<p><u>Voice Mail</u> Receives/ Saves voice messages. Press Play key to verify the message. To listen to the messages, you should know the password registered to the AddPac IP Next PBX.</p>
	<p><u>Conference Room</u> Shows a list of the conference calls which are available for connection at the present. Press the Call button to participate in the conference.</p>
	<p><u>VoD Browser</u> Enters the relevant VoD server address in the related menu settings to find the VoD details</p>
	<p><u>File Browser</u> Provides the file details after connecting a USB memory stick to the port on the back of the AP-VP120</p>
	<p><u>App. Setup</u> Configures the settings of VoD Browser, DVR and Document Sharing.</p>

Application - Voice Mail

This menu category displays received and saved voice messages and plays the messages to be listened. Use the user password registered to the AddPac IPNext PBX to listen to the messages.



(Figure 4-207) Screen Layout for Voice Mail Menu Sections

[Table 4-35] Description of Voice Mail Menu Section

Option	Description
Voice Msg. Inbox	The box for storing the received messages
Saved Voice Msg.	The box for storing the saved messages which have been received



(Figure 4-208) Menu >> Applications>> Voice Mail



(Figure 4-209) Voice Mail Menu Sections

Application - Conference Room

This menu displays a list of conference rooms which is available at the present and you may press the Call button to participate in one of the available conference rooms.

The available methods of conference are Ad Hoc, Dial-Out, Ad Hoc Dial-Out and Meet-Me and the user rank can be categorized as Ad Hoc, Dial-Out, Ad Hoc Dial-Out and Meet-Me.



(Figure 4-210) Screen Layout of Conference Room



(Figure 4-211) Menu >> Applications >> Conference Room

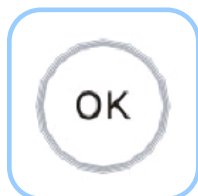

(Figure 4-212) Conference Room Menu Details

Application - VoD Browser

This feature can be used only when the AP-VP120 is connected with the AddPac VoD Server and provides the VoD video image and information supported by the server.



(Figure 4-213) Screen Layout of VoD Browser Menu Section



(Figure 4-214) Menu >> Application >> VoD Browser



(Figure 4-215) Connecting to VoD Server

Application - File Browser

This menu displays the file information in the USB device which is connected to the USB connector of the AP-VP120.

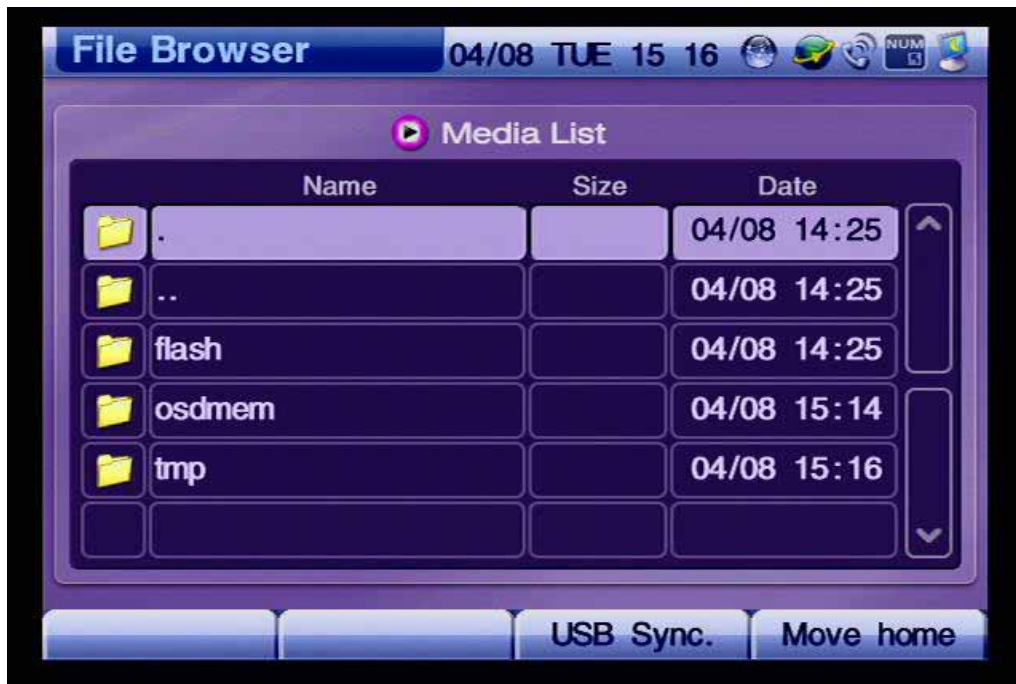

(Figure 4-216) Screen Layout of File Browser Menu Section



(Figure 4-217) Menu >> Applications>> App. Setup

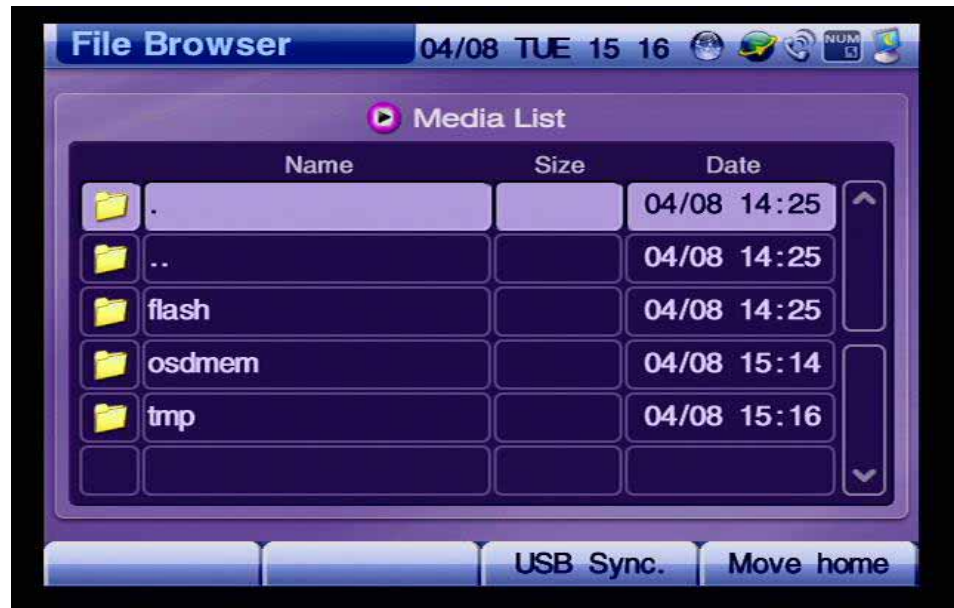

(Figure 4-218) Screen Layout of File Browser Menu Section

Application - Application Setup

This menu configures the settings for the VoD Browser server address, Document Share port and Window Size.

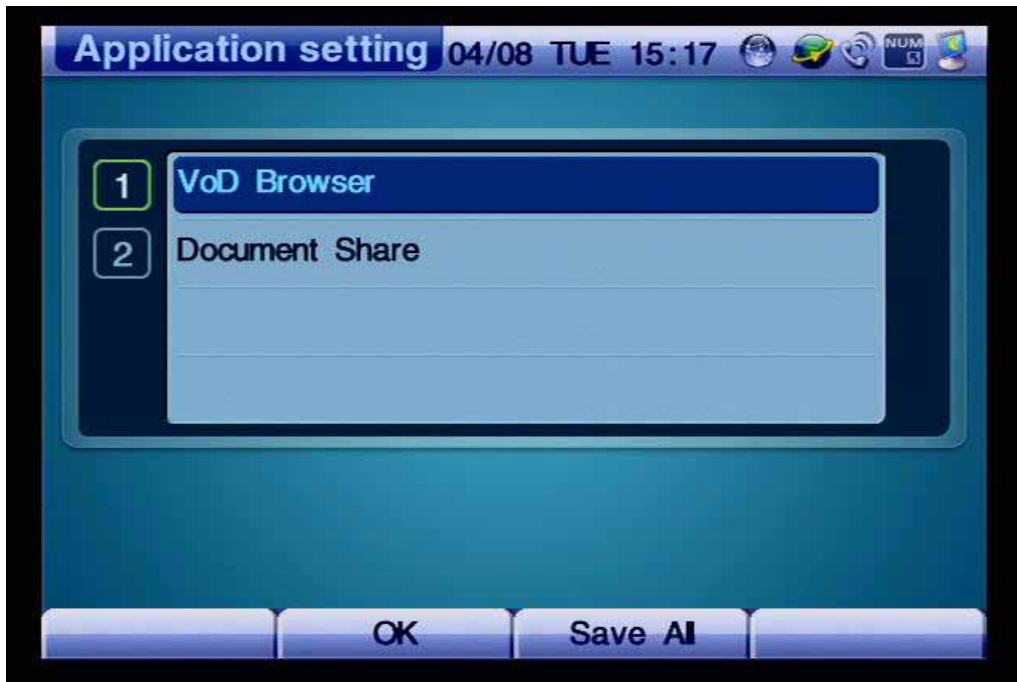

(Figure 4-219) Screen Layout of Application Setup Menu Section



(Figure 4-220) Menu >> Applications>> App. Setup



(Figure 4-221) Application Setup Menu

- VoD Browser

This menu detail specifies the address of VoD sever.



(Figure 4-222) Menu >> Applications>> App. Setup >> VoD Browser

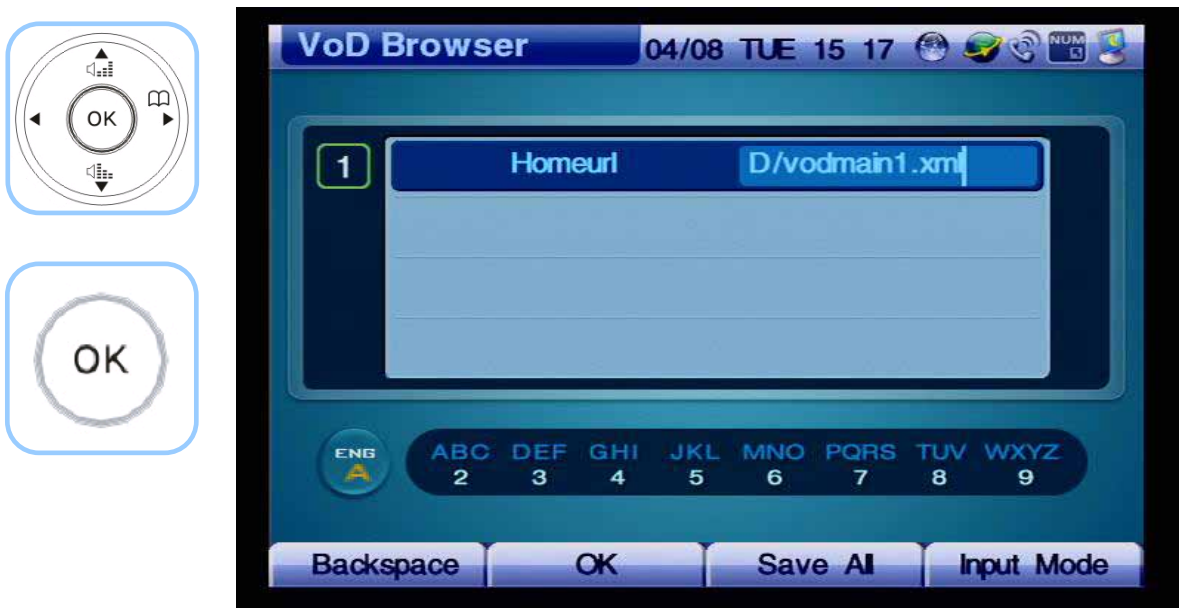

(Figure 4-223) Specifying VoD Server Address

- Document Share

This menu section sets the port for Document Share and Window Size



(Figure 4-224) Menu >> Applications >> Application Settings >> Document Share

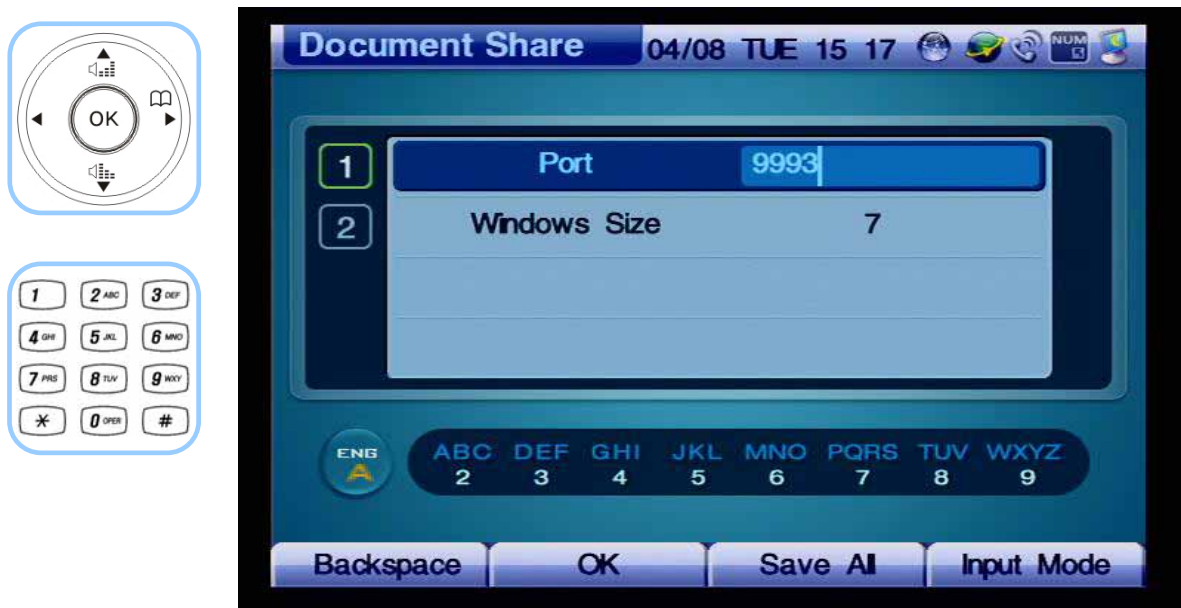

(Figure 4-225) Document Share Menu Details

Application - Message

You can use this feature only if the AP-VP120 interworks with the AddPac IPNext PBX through Smart Service Control Protocol (SSCP). You can send and check a short form of text message between the AddPac IP terminals using SSCP. You can send a message up to 9 receivers simultaneously and when you receive a message on the phone and you can be notified by a displayed note window.



(Figure 4-226) Screen Layout of Message Menu Details

[Table 4-36] Description of Message Menu Details

Menu Detail	Description
Write Text Message	Writes and sends a message
Received Message	The message box for the message that have been received
Saved Message	The message box for the messages that have been saved
Sent Message	The message box for the messages that have been sent



(Figure 4-227) Menu >> Applications>> SMS



(Figure 4-228) Message Menu Details

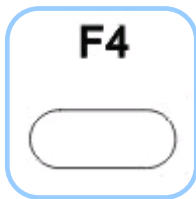

(Figure 4-229) Write Message

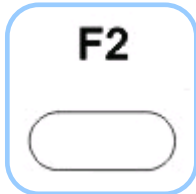

(Figure 4-230) Send the message



Remote Setup Menu

Remote Setup menu adjusts the settings for the other party’s Bandwidth, Frame Rate and Reject Remote. This menu can be used only between the AddPac IP terminals.

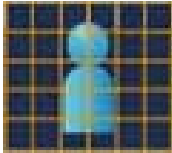

(Figure 4-231) Screen Layout of Remote Setup Menu Category

[Table 4-37] Description for Composition of Remote Setup Menu Sections

Menu Section	Description
	Sets the bandwidth of the other party’s AddPac IP terminal remotely, ranging from 128Kbps to 4160Kbps.
	Sets the resolutions and frame rate of the other party’s Addpac IP terminal remotely.
	Not allowing the other party to change the settings, by using one’s AddPac IP terminal, for the bandwidth and screen size of my AP-VP120 remotely.

Remote Setup - Bandwidth Remote



(Figure 4-232) Screen Layout of Bandwidth Remote Menu Details

The following figure shows an example for setting the bandwidth for video of the other party's AddPac video phone remotely:



(Figure 4-233) Menu >> Remote Setup



(Figure 4-234) Remote Setup >>Bandwidth



(Figure 4-235) Bandwidth Remote Menu Details

Remote Setup - VCodec Remote

This menu determines the Image Size and Frame Rate to be used by the other party's AddPac Video IP Phone. QVGA, HalfVGA and VGA are the available Image Size for MPEG-4 and QCIF, QVGA, CIF, HVGA, VGA are available for H.263. H.264 supports the Image Size of QVGA. You can select the Image Size (resolution) and Frame Rate on OSD.



(Figure 4-236) Video Codec Remote Menu Details

The following figure shows an example for selecting a video codec.



(Figure 4-237) Menu >> Remote Setup



(Figure 4-238) Remote Setup >> Video Codec

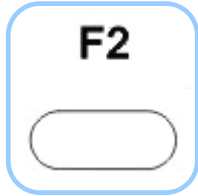

(Figure 4-239) Selecting the Image Size of QVGA at the Frame Rate of 30fps

Remote Setup - Reject Remote Control

This menu allows you to permit or reject the other party to access your VP120 remotely and adjust the image size, frame rate and bandwidth. Remote Controls Permit is set at default.



(Figure 4-240) Menu >> Remote Setup

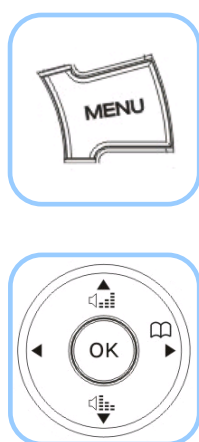

(Figure 4-241) Remote Setup >> Reject Remote



(Figure 4-242) Remote Setup >> Reject Remote



(Figure 4-243) Select the option to permit or reject remote control

Chapter 5. Using Console Commands

Basic Commands for Configuring Network Settings

* Commands for Verifying the Configured Settings

```
VideoPhone# show running-config
Building configuration...

Current configuration:
!
version 8.47.024
!
hostname VideoPhone
!
username root password router administrator
!
!
interface Loopback0
 ip address 127.0.0.1 255.0.0.0
!
interface FastEthernet0/0
 ip address 172.17.115.53 255.255.0.0
 ip nat outside
 speed auto
 qos-control 4096
!
interface FastEthernet0/1
 ip address 192.168.10.1 255.255.255.0
 ip nat inside
 speed auto
 no qos-control
!
ip route 0.0.0.0 0.0.0.0 172.17.1.1
!
access-list 100 permit ip 192.168.10.0 0.0.0.255 any
```

!

* Configuring IP, Default Route Settings

```
VideoPhone# configure terminal
VideoPhone(config)# interface fastethernet 0/0 → Fast Ethernet Interface Port 0
VideoPhone(config-if)# ip address 172.17.201.232 255.255.0.0 → IP Address Setting
VOIP_INTERFACE_DOWN
VOIP_INTERFACE_UP : (172.17.201.232)
VideoPhone(config-if)# exit
VideoPhone(config)# ip route 0.0.0.0 0.0.0.0 172.17.1.1 → Default Route Setting
VideoPhone(config)# end → Go to General Mode
VideoPhone#
VideoPhone# write → Save Settings
Proceed with write? [confirm]
Building configuration...
[OK] Configuration saved to flash:/apos.cfg
```

* Performing Ping Test to the Default Router

```
VideoPhone# ping 172.17.201.232
PING 172.17.201.232 (172.17.201.232): 56 data bytes
64 bytes from 172.17.201.232: icmp_seq=0 ttl=64 time=5 ms
64 bytes from 172.17.201.232: icmp_seq=1 ttl=64 time=5 ms
64 bytes from 172.17.201.232: icmp_seq=2 ttl=64 time=5 ms
64 bytes from 172.17.201.232: icmp_seq=3 ttl=64 time=5 ms
64 bytes from 172.17.201.232: icmp_seq=4 ttl=64 time=5 ms
64 bytes from 172.17.201.232: icmp_seq=5 ttl=64 time=5 ms
64 bytes from 172.17.201.232: icmp_seq=6 ttl=64 time=5 ms

--- 172.17.201.232 ping statistics ---
7 packets transmitted, 7 packets received, 0% packet loss'
round-trip min/avg/max = 5/5/5 ms
VideoPhone#
```

If the result of the ping test is good, the command entry for console to make a video call is completed.

Video Mode Command List

The basic video/audio configuration settings of your AP-VP120 can be changed by using the menu options of OSD. You can also change the setting by using Telnet depending on circumstance.

* Enter Video Mode

```
VideoPhone#  
VideoPhone# configure terminal  
VideoPhone(config)# video 0/0  
VideoPhone(config-video0/0)#  
VideoPhone(config-video0/0)#
```

[Table 5-1] Video Mode Command LIST

Command	Description	Default
audio-in	Audio input select	mic
audio-in-gain	Audio line input gain adjust	23
audio-mic-boost	Audio microphone boost 20dB	on
audio-out	Audio output select	Head
audio-out-gain	Audio headphone output gain adjust	121
video-in-bright	Video input brightness adjust	128
video-in-contrast	Video input contrast adjust	64
video-in-saturation	Video input saturation adjust	68
video-in-h-offset	Video input horizontal offset adjust	8
video-in-v-offset	Video input vertical offset adjust	19
video-out-bright	Video output brightness adjust	31
video-out-blue-gain	Video output blue gain adjust	128
video-out-red-gain	Video output red gain adjust	128
no	Set to default mode	

Selecting External Audio Input Port Mode

This command allows you to select line input or microphone input as mode of the external audio input port (Default: Microphone).

```
VideoPhone(config-video0/0)# audio-in ? => Enter ? to display a list of commands.  
line      Line input          => Line Input  
mic       Microphone input    => Microphone Input  
VideoPhone(config-video0/0)# audio-in line  
VideoPhone(config-video0/0)#  
VideoPhone(config-video0/0)# audio-in mic  
VideoPhone(config-video0/0)#
```

Adjusting Gain Value of External Audio Input Port

This command allows you to adjust the gain value of the external audio input port (Default: 23).

```
VideoPhone(config-video0/0)#  
VideoPhone(config-video0/0)# audio-in-gain ?  
Gain      [0 - 31]           => Setting Range  
VideoPhone(config-video0/0)# audio-in-gain 23  
VideoPhone(config-video0/0)#
```

Amplifying Microphone of External Audio Input Port

This command allows you to amplify the microphone of the external audio input port in microphone mode (Default: off).

```
VideoPhone(config-video0/0)#  
VideoPhone(config-video0/0)# audio-mic-boost ?  
on        Enable  
off       Disable  
VideoPhone(config-video0/0)# audio-mic-boost off  
VideoPhone(config-video0/0)#
```

Selecting External Audio Output Port Mode

This command allows you to change mode of the external audio output port on CLI (Default: headphone).

```
VideoPhone(config-video0/0)#  
VideoPhone(config-video0/0)# audio-out ?  
  line          Line output  
  head         Headphone output  
VideoPhone(config-video0/0)# audio-out head  
VideoPhone(config-video0/0)#
```

Adjusting Gain Value of External Audio Output Port

This command allows you to adjust the gain value of the external audio output port (Default: 121).

```
VideoPhone(config-video0/0)#  
VideoPhone(config-video0/0)# audio-out-gain ?  
  Gain         [0 - 127]  
VideoPhone(config-video0/0)# audio-out-gain 121  
VideoPhone(config-video0/0)#
```

Adjusting Video Input Brightness

This command allows you to adjust the brightness of the internal camera and composite input port (Default: 128).

```
VideoPhone(config-video0/0)#  
VideoPhone(config-video0/0)# video-in-bright ?  
  Brightness   [0 - 255]  
VideoPhone(config-video0/0)# video-in-bright 128  
VideoPhone(config-video0/0)#
```

Adjusting Video Input Sharpness

This command allows you to adjust the sharpness of the internal camera and composite input port (Default: 64).

```
VideoPhone(config-video0/0)#  
VideoPhone(config-video0/0)# video-in-contrast ?  
Contrast          [0 - 127]  
VideoPhone(config-video0/0)# video-in-contrast 64  
VideoPhone(config-video0/0)#
```

Adjusting Video Input Saturation

This command allows you to adjust the saturation of the internal camera and composite input port
(Default: 68).

```
VideoPhone(config-video0/0)#  
VideoPhone(config-video0/0)# video-in-saturation ?  
Saturation        [0 - 127]  
VideoPhone(config-video0/0)# video-in-saturation 68  
VideoPhone(config-video0/0)#
```

Adjusting Horizontal Video Input Offset

This command allows you to adjust the horizontal offset of the internal camera and composite
input port. This command is used to connect the external video devices of the DVD player, if
required **(Default: 8).**

```
VideoPhone(config-video0/0)#  
VideoPhone(config-video0/0)# video-in-h-offset ?  
H-offset          [2 - 254]  
VideoPhone(config-video0/0)# video-in-h-offset 8  
VideoPhone(config-video0/0)#
```

Adjusting Vertical Video Input Offset Value

This command allows you to adjust the vertical offset of the internal camera and composite input port. This command is used to connect the external video devices of the DVD player, if required
(Default: 19).

```
VideoPhone(config-video0/0)#  
VideoPhone(config-video0/0)# video-in-v-offset ?  
V-offset      [1 - 255]  
VideoPhone(config-video0/0)# video-in-v-offset 19  
VideoPhone(config-video0/0)#
```

Adjusting the Brightness of External Video Output Port

This command allows you to adjust the brightness of the internal LCD display and composite/S-VIDEO output port **(Default: 31).**

```
VideoPhone(config-video0/0)#  
VideoPhone(config-video0/0)# video-out-bright ?  
Brightness    [0 - 31]  
VideoPhone(config-video0/0)# video-out-bright 31  
VideoPhone(config-video0/0)#
```

Adjusting Color of External Video Output Port (Blue / Red)

This command allows you to adjust the color of the internal LCD display and composite/S-VIDEO output port. The colors are blue and red **(Default: 128).**

```
VideoPhone(config-video0/0)#  
VideoPhone(config-video0/0)# video-out-blue ?  
Gain          [0 - 255]  
VideoPhone(config-video0/0)# video-out-blue 128  
VideoPhone(config-video0/0)#  
VideoPhone(config-video0/0)# video-out-red ?  
Gain          [0 - 255]  
VideoPhone(config-video0/0)# video-out-red 128  
VideoPhone(config-video0/0)#
```

Chapter 6. Appendix

This Appendix describes the pin specification of the cables used for AP-VP120.

- Console port signal and pin-out (RJ-45 to DB9)
- Pin-out of the UTP cable (RJ-45 to RJ-45)

Console Port Signal and Pin-Out

The built-in RJ-45 to DB9 (female DTE connector) cable is used to connect the console port of this product to the PC where the terminal emulator software operates.

[Table 6-1] Console Port Pin-Out

Console Port (DTE)	RJ-45	DB-9	Console Device (PC)
Signal	RJ-45 Pin	DB-9 Pin	Signal
RTS	1	8	CTS
DTR	2	6	DSR
TxD	3	2	RxD
GND	4	5	GND
GND	5	5	GND
RxD	6	3	TxD
DSR	7	4	DTR
CTS	8	7	RTS

Pin-Out of UTP Cable (RJ-45 to RJ-45)

The RJ-45 to RJ-45 Ethernet cable is used to connect AP-VP300 to another device (typically hub). The pin sequence of the RJ-45 connector is shown in Figure 7-1. For the signals and specification, refer to Table 7-2, “Signals and Pin-Out of Serial Ethernet Cable”.

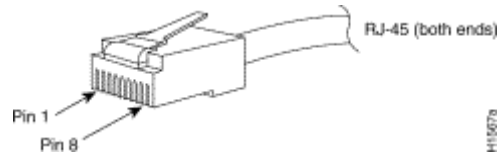

(Figure 6-1) 100Base-TX RJ-45 Connector

[Table 6-2] Signals and Pin-Out of Serial Ethernet Cable

RJ-45	Signal	Direction	RJ-45 Pin
1	Tx +	→	1
2	Tx -	→	2
3	Rx +	←	3
4	-	-	4
5	-	-	5
6	Rx -	←	6
7	-	-	7
8	-	-	8

- This specification is about the serial cable that connects AP-VP500 to the hub.
- Use a cross cable to connect AP-VP500 to either another AP-VP500 or a PC.

Abbreviation and Glossary

Glossary and Abbreviation	Definition
ADSL	Stands for Asymmetric Digital Subscriber Line. If you use ADSL, the central office will be connected to each home directly in a 1:1 method. In a down-link where data is transferred downward from the central office to the users, high-speed data communications of at least 1.5 Mb can be made. On the contrary, in an up-link from the users to the central office, communications are made very slowly. Thus, this service is called an asymmetrical service not a symmetrical service.
AP-VPMS	Stands for VoIP Plug & Play Management Software. This integrated management software developed by AddPac Technology enables VoIP products to be installed in a GUI environment, be monitored in real-time, or to be upgraded. This software also enables network administration.
API	Stands for Application Programming Interface. API is a function call legend standard that defines service interfaces.
APOS	Stands for AddPac Internetworking Operation System. This is an operating system that supports the network products developed by AddPac Technology.
ATM	Stands for Asynchronous Transfer Mode. This is an international cell relay standard for providing a variety of services such as voice, video, and data in the form of a cell of a fixed length (53 bytes). If you use a fixed-length cell, cell processing will be performed in the hardware; thus, transmission delay can be reduced. ATM is designed to make use of high-speed transmission media such as E3, SONET, and T3.
ATM High-Speed National Network	This network has been commercialized by the Korean government since 1993. The high-speed national network designed for governmental offices provides data services (transport network services) and Internet services. Data services are categorized into ATM, dedicated lines, packet exchange, and frame relay services. Internet services are categorized into Internet multi-services provided through ATM connection circuits and simple Internet services.
ATM Forum	This is an international organization founded by Cisco Systems, NET/ADAPTIVE, Northern Telecom, and Sprint in 1991 to reach the agreement of a standard for ATM technologies. ATM Forum expands the formal standards developed by ANSI and ITU-T and the agreements on the implementation of technologies.
Authentication	Operation of verifying the identification of a person or a process. This is a security feature.
BNC Connector	This is a standard connector used to connect IEEE 802.3 10Base-2 coaxial cables to

	Media Access Unit (MAU).
Boot Loader	This is a chip installed into a printed circuit board used to send executable boot commands to a network device.
Bps	Stands Bits per second. Typically called bps. Reference: Bit Rate.
Cable Modem	This device converts analog signals to digital signals in order to enable the Internet through a cable network. Since telephone networks are made of copper wires and cable networks are made of coaxial and optical cables, the bandwidth of cable networks are much wider than that of telephone networks. However, the modulation/demodulation technology, which converts digital to analog and vice versa, is required for cable networks when data is transferred.
Call Center	Call Center is a central place where calls from customers and other people are processed systematically. Computer automation is implemented in Call Center to some degree. Typically, Call Center processes many calls simultaneously, categorizes calls, connects the calls to personnel, and records calling logs automatically. Call Center is typically used for mail order catalog firms, telemarketing firms, customer centers for PC products, and large enterprises that sell products or provide services.
Caller ID	Caller ID is a call service that enables the phone number of the caller to be sent to the recipient. To see the phone number, a digital reader should be installed into the phone.
Category 5 cabling	One of the five-level UTP cable connection methods specified by the EIA/TIA-586 standard. Category 5 cabling enables data to be transferred at a rate of up to 100Mbps.
CBR	Stands for Constant Bit Rate. The ATM network QoS class CBR defined by ATM Forum is used for a connection device that is based on a precise clock processing method to ensure untwisted data transfer.
CES	Stands for Circuit Emulation Service. This service allows you to multiplex multiple line emulation streams for voice and video with packet data through a single high-speed ATM link without using a separate ATM access multiplexer.
Checksum	This is a method for checking the integrity of transferred data. Checksum is an integer calculated from the octet sequence obtained by a series of operations. This value is calculated by the recipient again for verification.
Coaxial cable	This coaxial cable is made of an external cylinder-type conductor that wraps an internal wire conductor. Examples of the coaxial cables used for LAN include 50Ω cables used for digital signal processing and 75Ω cables used for high-speed digital signal processing.
CODEC	Stands for COder-DECoder. CODEC is: 1. A built-in circuit device that converts analog signals to digital bit streams and vice versa based on a pulse code modulation method; 2.

	A DSP software algorithm that compresses or decompresses voice or audio signals over Voice over IP, Voice over Frame Relay, or Voice over ATM.
Console	A DTE interface through which a command enters a host
	Stands for Class of Service. CoS refers to the standard method that enables a higher-level protocol to make a lower-level protocol process messages. For the SNA lower-level area routing, CoS is used to determine the optional path for lower-level area nodes to set a given session. CoS consists of a virtual path number and a transmission priority field. Also called ToS
CoS	
	Decryption means restoring data to the original non-encrypted state by applying the encryption algorithm to the encrypted data in reverse.
Decryption	
	Stands for Dynamic Host Configuration Protocol. DHCP has a mechanism that reassigns an IP address dynamically in order for the host to recycle unnecessary IP addresses.
DHCP	
	Stands for Domain Name Server. This is a server system used for the Internet to convert the name of a network node name to an address.
DNS	
	Stands for Digital Signal level 3. This is a frame processing standard used to transmit digital signals at a rate of T3 (44.736Mbps).
DS-3	
	Stands for Digital Signal Processor. This is a dedicated processor that processes only digital signals. DSP is used as a sub-processor for voice processing in NEXT.
DSP	
	Stands for Dual Tone MultiFrequency. Two voice-band tones are simultaneously used for dialing (just like touch tones).
DTMF	
	Stands for either receive and transmit or Ear and Mouth. Typically, this is a trunking device used for switch-to-switch or switch-to-network two-way communications. The analog E&M interface of Cisco is a RJ-48 connector for PBX trunk lines. E&M is available for E1/T1 digital interfaces.
E&M	
	This is a wide area digital transmission technique used mainly in Europe. E1 enables data transfer at a rate of 2,048Mbps. E1 can be lent by regular service providers for a private use.
E1	
	Encryption means that a specific algorithm is applied to data in order to convert data to a form that unauthorized users cannot identify.
Encryption	
	Baseband LAN standard initiated by Xerox Corporation and co-developed by Xerox, Intel, and DEC. CSMA/CD is used for Ethernet networks, which operate through a variety of cables at a rate of 10Mbps. Ethernet is similar to the IEEE 802.3 standard. Reference: 10Base-2, 10Base5, 10Base-F, 10Base-T, 10Broad-36, Fast Ethernet, and IEEE 802.3.
Ethernet	
	Abbreviation of Facsimile. FAX refers to the transmission of scanned texts or images to
FAX	

	<p>a printer or an output device connected to another phone number by using a telephone line. Once the original document is read by a facsimile, the facsimile treats the document as a fixed graphic image, and converts it to bitmap. In this digital form, data is transferred in the form of an electrical signal through a phone system. The receiving facsimile restores the data to a encoded image, and prints it on a sheet of paper.</p> <p>Logical group of data transferred to a data link layer unit through a transmission medium. From frames, the header and trailer that include user data are important. Headers and trailers are used for synchronization and error control. Cells, datagrams, messages, packets, and segments are used to describe logical data groups in various layers of OSI or based on various technologies.</p>
Frame	<p>This is an industry-standard switching-type data link layer protocol that processes multiple virtual lines in inter-connected devices by using the HDLC encapsulation. Frame-Relay is more efficient than X.25.</p>
Frame-Relay	<p>Stands for File Transfer Protocol. FTP, which is an application protocol, is part of the TCP/IP protocol stack used for file transfer between network nodes. FTP is defined in RFC 959.</p>
FTP	<p>Stands for Foreign Exchange Office. The FXO interface is connected to the switching center of Public Switched Telephone Network (PSTN), and is provided by a regular phone. The FXO interface of Cisco is a station interface of the switching center or PBX on PSTN, and is a RJ-11 connector for analog connection devices.</p>
FXO	<p>Stands for Foreign Exchange Station. The FXS interface is directly connected to a standard phone, and provides a ring-back tone, voltage, and a dial tone. The FXS interface of Cisco is a RJ-11 connector for basic telephone service devices, keyset, and PBX.</p>
FXS	<p>This specifies the PCM voice coding technique of 64Kbps. Voice is encoded under G.711 in an appropriate format that enables digital voice transmission over either PSTN or PBX. G.711 is specified under the ITU-T standard of G-series recommendation.</p>
G.711	<p>This is one of the H.324 standards, and specifies a compression technique that enables voice or audio signal elements to be compressed at a very low bit transmission rate. This CODEC is related to the bit transmission rates of 5.3Kpbs and 6.3Kpbs. The high bit transmission rate is based on the MLMLQ technology, and provides high quality sounds. The low bit transmission rate is based on CELP, and ensures high flexibility for system designers. This standard is specified under the G-series ITU-T standard.</p>
G.723.1	<p>This standard specifies ADPCM coding performed at a rate of 40Kbps, 32Kbps, 24Kbps, or 16Kbps. If the PBX network is configured to support ADPCM, you can exchange</p>
G.726	

G.728	<p>ADPCM encoding voice with packet voice networks, PSTN, or PBX networks. This standard is specified under the ITU-T standard of G-series recommendation.</p> <p>This standard specifies variations that ensure low delay of CELP voice compression performed at 16Kbps. The CELP voice coding should be converted to a public telephony format for transmission over either PSTN or PSTN. This standard is specified under the ITU-T standard of G-series recommendation, and defines the CELP compression that encodes G.729 voice to a stream of 8Kbps. G.728 has two variations (G.729 and G.729 Annex A), and the variations are different in terms of calculation complexity. The two variations have voice quality similar to ADPCM of 32Kbps. G.728 is specified under the ITU-T standard of G-series recommendation.</p>
Gatekeeper	<p>This is the component of the H.323 video conference system that analyzes a caller ID, controls access authorization, and manages the subnet bandwidth. A gatekeeper is H.323 entity that provides the features that enable address conversion and LAN access control to the H.323 terminal and gateway on LAN. Gatekeepers can provide other services such as bandwidth control and search for a gateway to the H.323 terminal and gateway. This device manages a device registry on a multimedia network. The devices are registered with the gatekeeper, and they request the gatekeeper to authorize a call.</p>
H.225	<p>This ITU standard is applied to the session setting and packetization of H.225.0. H.225.0 specifies a variety of protocols such as RAS, Q.931, and RTP.</p>
H.245	<p>This ITU standard is applied to H.245 endpoints control.</p>
H.323	<p>This standard is an extension of the ITU-T standard H.320 that enables voice conferences over LAN or another packet switching network as well as video transmission over the Internet.</p>
HBD3	<p>This is a type of line codes used for E1.</p>
HDLC	<p>Stands for High-Level Data Link Control. HDLC is a transmission protocol used in the data link layer, which is the second layer of the 7-layer OSI model. HDLC is used in the X.25 packet switching network. Data consists of frames in HDLC, and frames are transmitted through a network. The destination verifies if the frames have been successfully transmitted. The HDLC protocol includes data for controlling data flow and troubleshooting errors in a data frame.</p>
Hookflash	<p>This is a short on-hook duration of a device such as phones during a call. Hookflash means that a phone attempts to make a dial tone recall through PBX. This is usually used to perform call transfer.</p>
HTTP	<p>Stands for Hypertext Transfer Protocol. This protocol enables a Web browser or a Web server to transfer files such as text files and graphic files.</p>

IPSec

Stands for Internet Protocol Security protocol. IPSec is a still developing standard for the security of networks or the packet processing layer of network communications. In the previous security techniques, security has been included in the application layers of a communication model. IPSec is particularly useful for the implementation of remote user access through dial-up access to Virtual Private Networks (VPN) and regular private networks. The main advantage of IPSec is that security can be ensured without replacing an individual user PC with a new one. Cisco takes the initiative of suggesting IPSec as the standard, and has embedded support to this feature into its network router.

IPv6

IPv6 is the latest IP, and has been embedded into part of IP support into many products including the operating systems of PC. IPv6 is called IP Next Generation (IPng), that is the next-generation IP. IPv6 is the formal IETF standard. IPv6 is designed as an evolutionary version of the currently used IP version 4. Network hosts or intermediate nodes that adopt either IPv4 or IPv6 can process any packets formulated by either IPv4 or IPv6; thus, the users and service providers can upgrade their IP to IPv6 individually without collaboration.

ISP

Stands for Internet Service Provider. ISP refers to service providers that provide Internet access services, Web site construction and Web hosting services to individuals or enterprises. ISP has devices and communication lines required for Internet access, and large ISPs have their own high-speed dedicated lines in order to provide services that have better quality and are less dependent on telephone network service providers to their customers. The large nationwide ISPs of the U.S. are AT&T WorldNet, IBM Global Network, MCI, Netcom, UUNet, and PSINet. Those of Korea are INet, Channeli, Netsgo, and Netian. The users access the Internet through online service providers. The main online service providers of the U.S. are America Online and Compuserve, and those of Korea are Chollian, Unitel, and Hitel.

ITU-T

Stands for International Telecommunication Union Telecommunication Standardization Sector. This is an international organization that develops global standards on communication technologies. ITU-T performs the previous tasks of CCITT.

IVR

Stands for Interactive Voice Response. IVR refers to a system that provides data in the form of recorded messages through phone lines as a response to user input in the form of human voice or mainly DTMF signal processing. Examples are banks that allow you to check balance by using a phone or automated stock quotations system.

LAN

Stands for Local Area Network. This is a low-error, high-speed data network that covers relatively small geographical areas of up to several thousand meters. LAN inter-connects workstations, peripherals, terminals, and other devices in a building or a geographically

	<p>limited area. The LAN standard specifies a cable connection and signal processing method in the physical layer and data link layer of the OSI model. Reference: MAN, WAN.</p>
Link	<p>This is a network communication channel configured with lines or a transmission path between the transmitter and receiver and related devices. A link mainly refers to WAN connections, and is sometimes called a line or a transmission link.</p>
Loopback Test	<p>This test is performed as follows: Transmit a signal or return it to the transmitter at a location on the communication path. This loopback test is usually performed to test the availability of network interfaces.</p>
MAC Address	<p>Stands for Media Access Control Address. This is a standard data link layer address required for any and all ports and devices connected to LAN. Other devices on a network use this address to locate a specific port within the network and to create or update a routing table and data structure. A MAC address is 6 bytes long, and is managed by IEEE. A MAC address is called as a hardware address, a MAC-layer address, or a physical address. Compare to: Network Address</p>
MAN	<p>Stands for Metropolitan-Area Network. This network covers the entire area of a large city. The operation area of MAN is geographically larger than that of LAN; however, is smaller than that of WAN. Compare to: LAN, WAN.</p>
MGCP	<p>MGCP, which is also known as H.248 or Megaco, is a standard protocol required to operate signals required during a multimedia conference or to manage sessions. This protocol defines a method of communications between the media gateway that converts the data format required for a circuit switching network to the one required for a packet switching network and the media gateway control device. MGCP may be used to set up, manage, and complete calls among multiple endpoints. Megaco and H.248 are the improved version of MGCP.</p>
NAT	<p>Stands for Network Address Translation. NAT is a mechanism for reducing the need for globally unique IP addresses. NAT allows you to access the Internet as an organization whose address is not globally unique converts the address to an address space where the address can be globally routed. NAT is also called Network Address Translator.</p>
NTP	<p>Stands for Network Time Protocol. NTP, which is built based on TCP, sets a local time accurately based on a wireless clock and an atomic clock on the Internet. NTP can synchronize a distributed clock in the unit of milliseconds for a long time.</p>
PABX	<p>Stands for Private Automatic Branch eXchange. PABX is a switch for phones used at enterprises. PABX is used in Europe, while PBX is used in the U.S.</p>
Packet	<p>A packet is a group of logical data that contains user data and a header where control</p>

	data is contained. A packet mainly refers to the unit of network layer data.
PBX	Stands for Private Branch eXchange. PBX, which is located in a subscriber building, is a digital or analog phone switchboard used to connect private networks to public phone networks.
PING	Stands for Packet INternet Groper. ICMP echo-processes a response between messages. PING is used for an IP network to test the accessibility of network devices.
Point to Point Connection	One of the two basic connection types. In ATM, the point to point connection may be either a one-way connection or a two-way connection between two ATM end systems.
Pont to Multipoint Connection	One of the two basic connection types. In ATM, the point to multipoint connection is a one-way connection method that enables a transmitting end-system (root node) to be connected to multiple receiving end-systems (riff). Compare to: Point to Point Connection
POTS	Stands for Plain Old Telephone Service. Reference: PSTN.
PPP	Stands for Point-to-Point Protocol. This protocol is the advanced version of SLIP that enables a router-to-router connection or a host-to-network connection through synchronous or asynchronous lines. SLIP is designed to be used on an IP, while PPP is used along with network layer protocols such as IP, IPX, and ARA. PPP has a bulletin board security mechanism such as CHAP and PAP. PPP has two sub-protocols, LCP and NCP. Reference: CHAP, LCP, NCP, PAP, and SLIP
Protocol Stack	This is a collection of communication protocols that inter-work with one another and that process communications in part or all of the seven layers of the OSI reference model. All protocol stacks are not related to each layer of the OSI model, and one protocol of a stack can process multiple layers at one time. TCP/IP is a typical protocol stack.
PSTN	Stands for Public Switched Telephone Network. PSTN is a general term that refers to various telephone networks and services used worldwide. PSTN is also called POTS.
PVC	Stands for either Permanent Virtual Circuit or Permanent Virtual Connection. PVC is a virtual circuit installed permanently. PVC allows you to reduce a bandwidth for setting up or releasing a circuit when a specific virtual circuit must always exist. As an ATM term, PVC is called Permanent Virtual Connection.
Q.931 Signaling	This is an ITU standard that specifies ISDN signal processing methods. The H.225.0 standard uses a variation of Q.931 to set up or disconnect the session of H.323.
QoS	Stands for Quality of Service. QoS is the criterion of measuring the performance (e.g. transmission quality and service availability) of a transmission system.
RAM	Stands for Random-Access Memory. RAM is a volatile memory that can be read or written by a microprocessor.

RAS

RAS refers to a protocol for registration, connect acknowledgement, and status protocol. RAS is used for H.323 to find or have a conversation with a gateway.

RISC

Stands for Reduced Instruction Set Computing.

Router

This is a network layer device that determines the optional route to which network traffic is delivered by using one or more metrics. A router forwards packets from a network to another network based on the network layer information. A router is sometimes called a gateway. (A gateway in this meaning is getting older.) Compare to: Gateway; Reference: Relay

RS-232

This is a frequently used physical layer interface, and is known as EIA/TIA-232 nowadays.

RTCP

Stands for RTP Control Protocol. This protocol monitors the QoS of IPv6 RTP connections, and transfers data on sessions in operation. Reference: Real-Time Transport Protocol (RTP)

RTP

1. Stands for Routing Table Protocol. This VINES routing protocol based on RIP distributes network topology data, and helps the VINES server that searches for adjoining clients, servers, and routers. A delay time is used as a routing metric. Reference: SRTP

2. Stands for Rapid Transport Protocol. RTP provides facing and error recovery services to the APPN data when the data passes the APPN network. RTP allows you to check error recovery and flow control synthetically. RTP does not recover but prevents traffic congestion.

3. Stands for Real-Time Transport Protocol. This is one of the IPv6 protocols. RTP is designed to enable the synthetic network transmission feature in the application that transfers real-time data such as audio, video, and simulation data through multicast or unicast network services. RTP enables the real-time application to identify a payload type, specify a sequence number, perform time-stamping, and to monitor a transmission procedure.

SIP

Stands for Session Initiation Protocol. SIP is an application layer control protocol based on very simple texts, and allows more than one user to make, correct, or complete a session. Examples of sessions include remote conferences, phones, meetings, event notifications, and instant messaging on the Internet. SIP is independent to lower-level packet protocols (e.g. TCP, UDP, ATM, and X.25).

SmartViewer

This is software that allows you to monitor AP-GK1000, AP-GK2000, and AP-GK3000, which are the gatekeeper series of AddPac Technology, in a Graphical User Environment (GUI) environment in real-time and to search or manage statistical data.

SNMP

Stands for Simple Network Management Protocol. This is a network management protocol almost dedicated to TCP/IP networks. SNMP monitors and controls network devices, and manages setup, collection of statistical data, operation performance, and security features. Reference: SGMP and SNMP2

T1

This is the facility of a digital WAN service provider. T1 uses the AMI or B8ZS coding method to transfer DS-1 format data at a rate of 1.544Mbps over a phone switching network. Compare to: E1; Reference: AMI, B8ZS, DS-1

TCP/IP

Stands for Transmission Control Protocol/Internet Protocol. TCP/IP is a general name of the protocol suites developed in the seventies by DoD of the U.S. to help build a global inter-network. TCP and IP are two of the best known protocol suites. Reference: IP and TCAP

Telco

Stands for Telephone Company. Telco refers to a telephone service provider. Typically, Telco means individual local telephone service providers such as Bell, and sometimes includes long distance telephone service providers.

Telnet

This is a standard terminal emulation protocol included in the TCP/IP protocol stacks. Telnet is used to connect remote terminals. Telnet allows you to log into a remote system and to use the resources like they are connected to a local system. Telnet is defined in RFC 854.

VCI

Stands for Virtual Channel Identifier. VCI refers to a 16-bit field in the header of an ATM cell. VCI as well as VPI allows you to identify the next receiver of a cell while the cell is being delivered to the receiver through a series of ATM switches. The ATM switches use the VPI/VCI field to identify the next network VCI that the cell should pass to reach the receiver, which is the final destination. The features of VCI are similar to those of DLCI.

VDSL

Stands for Very-high-data-rate Digital Subscriber Line. VDSL is one of the four DSL technologies. VDSL provides downstream of 13 Mbps to 52 Mbps and upstream of 1.5Mbps to 2.3Mbps through a pair of twisted copper wires. The operation range of VDSL is limited to 1,000ft to 4,500ft (304.8m to 1,372m). Compare to: ADSL, HDSL, and SDSL

VoATM

Stands for Voice Over ATM. VoATM enables a router to deliver voice traffic (e.g. phone calling or facsimile) over an ATM network. Voice traffic is encapsulated in a specific AAL encapsulation method for multiplexed voice when voice traffic is sent in ATM.

VoFR

Stands for Voice Over Frame Relay. VoFR enables a router to deliver voice traffic (e.g. phone calling or facsimile) over a frame relay network. When voice traffic is sent through frame relay, the voice traffic is encapsulated after being decomposed into segments by using the FRF.12 encapsulation technique to pass the frame relay network.

VoHDLC

Stands for Voice over HDLC. Voice over HDLC enables a router to deliver live voice traffic (e.g. phone calling and facsimile) to another router through a serial line.

VoIP

Stands for Voice over IP. VoIP is a capability that enables normal telephony voice of the same features, reliability, and voice quality as POTS to deliver over the IP-based Internet. VoIP enables a router to deliver voice traffic (e.g. phone calling and facsimile) over an IP network. Over VoIP, DSP decomposes voice signals into frames, and a pair of the decomposed frames is grouped. Then, the grouped frames are saved in a voice packet. The voice packet is forwarded by using an IP under the ITU-T standard, H.323.

VPN

Stands for Virtual Private Network. VPN allows you to encrypt entire traffic that moves from a network to another network so that IP traffic can safely move over a public TCP/IP network. On VPN, all data is encrypted in an IP level by using the 'tunneling' technique.

WAN

Stands for Wide-Area Network. WAN is a data communication network that provides services to the users in a wide area and that uses transmission services provided by regular service providers. Examples of WAN include frame relay, SMDS, and X.25.

Compare to: LAN and MAN

AddPac



AddPac Technology Co., Ltd.
Floors # 2 and 3, Jeong Am Bldg., 769-
12, Yoksam-dong, Kangnam-ku, Seoul
Phone (02) 568-3848 (Rep.)
Facsimile (02) 568-3847
E-mail Address: info@addpac.com
<http://www.addpac.com>