

R&S®NGP800

Power Supply Series

User Manual



This manual describes the following R&S®NGP800 models with firmware version 1.00 or higher:

- R&S®NGP802 Two-channel 32V/20A Power Supply 400 W (5601.4007.05)
- R&S®NGP822 Two-channel 64V/10A Power Supply 400 W (5601.4007.06)
- R&S®NGP804 Four-channel 32V/20A Power Supply 800 W (5601.4007.02)
- R&S®NGP824 Four-channel 64V/10A Power Supply 800 W (5601.4007.03)
- R&S®NGP814 Four-channel 32V/20A & 64V/10A Power Supply 800 W (5601.4007.04)

In addition to the base unit, the following options are described:

- R&S®NG-B105 Option IEEE-488 (GPIB) Interface (5601.6000.02)
- R&S®NGP-K102 Option Wireless LAN (5601.6400.03)
- R&S®NGP-K103 Option Digital I/O (5601.6300.03)
- R&S®NGP-K107 Option Analog Input (5601.6200.03)

© 2020 Rohde & Schwarz GmbH & Co. KG

Mühlhofstr. 15, 81671 München, Germany

Phone: +49 89 41 29 - 0

Fax: +49 89 41 29 12 164

Email: info@rohde-schwarz.com

Internet: www.rohde-schwarz.com

Subject to change – Data without tolerance limits is not binding.

R&S® is a registered trademark of Rohde & Schwarz GmbH & Co. KG.

Trade names are trademarks of the owners.

5601.5610.02 | Version 03 | R&S®NGP800

Throughout this manual, products from Rohde & Schwarz are indicated without the ® symbol, e.g. R&S®NGP800 is indicated as R&S NGP800.

Safety Instructions

Instrucciones de seguridad

Sicherheitshinweise

Consignes de sécurité

WARNING

Risk of injury and instrument damage

The instrument must be used in an appropriate manner to prevent electric shock, fire, personal injury or instrument damage.

- Do not open the instrument casing.
 - Read and observe the "Basic Safety Instructions" delivered as printed brochure with the instrument.
 - Read and observe the safety instructions in the following sections. Note that the data sheet may specify additional operating conditions.
 - Keep the "Basic Safety Instructions" and the product documentation in a safe place and pass them on to the subsequent users.
-

ADVERTENCIA

Riesgo de lesiones y daños en el instrumento

El instrumento se debe usar de manera adecuada para prevenir descargas eléctricas, incendios, lesiones o daños materiales.

- No abrir la carcasa del instrumento.
 - Lea y cumpla las "Instrucciones de seguridad elementales" suministradas con el instrumento como folleto impreso.
 - Lea y cumpla las instrucciones de seguridad incluidas en las siguientes secciones. Se debe tener en cuenta que las especificaciones técnicas pueden contener condiciones adicionales para su uso.
 - Guarde bien las instrucciones de seguridad elementales, así como la documentación del producto, y entréguelas a usuarios posteriores.
-

⚠️ WARNUNG**Gefahr von Verletzungen und Schäden am Gerät**

Betreiben Sie das Gerät immer ordnungsgemäß, um elektrischen Schlag, Brand, Verletzungen von Personen oder Geräteschäden zu verhindern.

- Öffnen Sie das Gerätegehäuse nicht.
 - Lesen und beachten Sie die "Grundlegenden Sicherheitshinweise", die als gedruckte Broschüre dem Gerät beiliegen.
 - Lesen und beachten Sie die Sicherheitshinweise in den folgenden Abschnitten; möglicherweise enthält das Datenblatt weitere Hinweise zu speziellen Betriebsbedingungen.
 - Bewahren Sie die "Grundlegenden Sicherheitshinweise" und die Produktdokumentation gut auf und geben Sie diese an weitere Benutzer des Produkts weiter.
-

⚠️ AVERTISSEMENT**Risque de blessures et d'endommagement de l'appareil**

L'appareil doit être utilisé conformément aux prescriptions afin d'éviter les électrocutions, incendies, dommages corporels et matériels.

- N'ouvrez pas le boîtier de l'appareil.
 - Lisez et respectez les "consignes de sécurité fondamentales" fournies avec l'appareil sous forme de brochure imprimée.
 - Lisez et respectez les instructions de sécurité dans les sections suivantes. Il ne faut pas oublier que la fiche technique peut indiquer des conditions d'exploitation supplémentaires.
 - Gardez les consignes de sécurité fondamentales et la documentation produit dans un lieu sûr et transmettez ces documents aux autres utilisateurs.
-

Customer Support

Technical support – where and when you need it

For quick, expert help with any Rohde & Schwarz equipment, contact one of our Customer Support Centers. A team of highly qualified engineers provides telephone support and will work with you to find a solution to your query on any aspect of the operation, programming or applications of Rohde & Schwarz equipment.

Up-to-date information and upgrades

To keep your instrument up-to-date and to be informed about new application notes related to your instrument, please send an e-mail to the Customer Support Center stating your instrument and your wish. We will take care that you will get the right information.

Europe, Africa, Middle East

Phone +49 89 4129 12345
customersupport@rohde-schwarz.com

North America

Phone 1-888-TEST-RSA (1-888-837-8772)
customer.support@rsa.rohde-schwarz.com

Latin America

Phone +1-410-910-7988
customersupport.la@rohde-schwarz.com

Asia/Pacific

Phone +65 65 13 04 88
customersupport.asia@rohde-schwarz.com

China

Phone +86-800-810-8228 /
+86-400-650-5896
customersupport.china@rohde-schwarz.com



Contents

1	Documentation Overview.....	7
2	Welcome to R&S NGP800.....	9
3	Important Notes.....	11
3.1	Symbols.....	11
3.2	Ambient Conditions.....	11
3.3	Measurement Categories.....	12
3.4	Mains Voltage.....	12
3.5	Limits.....	13
4	Getting Started.....	14
4.1	Putting into Operation.....	14
4.1.1	Safety.....	15
4.1.2	Intended Operation.....	16
4.1.3	Unpacking and Checking the Instrument.....	17
4.1.4	Setting Up the Instrument.....	18
4.1.4.1	Bench Operation.....	19
4.1.4.2	Rack Mounting.....	19
4.2	Instrument Tour.....	20
4.2.1	Overview of Controls.....	20
4.2.1.1	Front Panel.....	20
4.2.1.2	Rear Panel.....	22
4.2.2	Switching On the Instrument.....	24
4.3	Trying Out the Instrument.....	24
4.3.1	Setting the Output Voltage and Current Limit.....	24
4.3.2	Activating the Channels Output.....	26
4.4	Maintenance.....	27
5	Operating Basics.....	29
5.1	Display Overview.....	29
5.1.1	Status Bar Information.....	29
5.1.2	Channel Display Area.....	32
5.2	Using the Touchscreen.....	33

5.2.1	Using Gestures.....	33
5.2.2	Accessing Functionality in the Home Window.....	34
5.2.2.1	Settings Button.....	34
5.2.2.2	Voltage and Current Inputs.....	35
5.2.2.3	Expand/Collapse Button.....	35
5.2.3	Input Data.....	36
5.3	Front Panel Keys.....	37
5.3.1	Menu Controls.....	37
5.3.1.1	Home Key.....	37
5.3.1.2	Settings Key.....	37
5.3.1.3	User Key.....	40
5.3.2	Navigation Controls.....	40
5.3.3	Output and Channel Controls.....	41
5.4	Output Power Auto Ranging.....	41
5.5	Operation Modes.....	42
6	Instrument Functions.....	43
6.1	Setting the Channels Voltage and Current.....	43
6.2	Activating the Channels Output.....	44
6.2.1	Output.....	45
6.2.1.1	Delay.....	45
6.2.1.2	Remote Sense.....	47
6.3	Analog Input.....	48
6.4	Protection.....	49
6.4.1	Over Current Protection (OCP).....	50
6.4.2	Over Voltage Protection (OVP).....	50
6.4.3	Over Power Protection (OPP).....	51
6.4.4	Safety Limits.....	52
6.5	Tracking Function.....	53
6.6	Digital Trigger I/O.....	54
6.7	Advanced Features.....	57
6.7.1	QuickArb.....	57
6.7.2	EasyRamp.....	60
6.8	User Key.....	61

6.9 Screenshot	62
6.10 Data Logging	63
6.11 CSV Settings	65
6.12 File Manager	66
6.13 Store and Recall	67
6.14 Interfaces	69
6.14.1 Network Connection.....	70
6.14.1.1 LAN Connection.....	71
6.14.1.2 Wireless LAN Connection.....	73
6.14.2 USB Connection.....	74
6.14.3 GPIB Address.....	75
6.15 General Instrument Settings	76
6.15.1 Licenses Management.....	76
6.15.2 Appearance Settings.....	77
6.15.3 Sound Settings.....	78
6.15.4 Date and Time.....	79
6.15.5 Device Information.....	79
6.15.6 Update Device.....	80
6.16 Adjustment	81
6.16.1 Analog In Adjustment.....	82
6.16.2 Channel Adjustment.....	84
7 Remote Control Commands	88
7.1 Common Setting Commands	88
7.2 System Settings Commands	91
7.3 Display Commands	96
7.4 Trigger Commands	97
7.5 Configuration Commands	101
7.5.1 Channel Selection.....	101
7.5.2 Safety Limit Setting.....	103
7.5.3 Remote Sense Setting.....	105
7.5.4 Voltage Setting.....	106
7.5.5 Current Setting.....	109
7.5.6 Combined Setting of Voltage and Current Settings.....	112

7.5.7	Output Setting.....	113
7.5.8	OCP Setting.....	116
7.5.9	OVP Setting.....	120
7.5.10	OPP Setting.....	123
7.5.11	Reset Protection Tripped State.....	126
7.5.12	Tracking Setting.....	126
7.6	Measurement Commands.....	127
7.7	Advanced Operating Commands.....	130
7.7.1	Arbitrary.....	130
7.7.2	EasyRamp.....	137
7.7.3	Analog Input.....	138
7.7.4	Adjustment.....	139
7.8	Data and File Management Commands.....	143
7.9	Status Reporting Commands.....	149
7.9.1	STATus:OPERation Registers.....	149
7.9.2	STATus:QUESTionable Registers.....	151
	Annex.....	154
A	Additional Basics on Remote Control.....	154
A.1	Messages and Command Structure.....	154
A.1.1	Messages.....	154
A.1.2	SCPI Command Structure.....	155
A.2	Command Sequence and Synchronization.....	159
A.2.1	Preventing Overlapping Execution.....	159
A.3	Status Reporting System.....	159
A.3.1	Structure of a SCPI Status Register.....	160
	List of Commands.....	165
	Index.....	169

1 Documentation Overview

This section provides an overview of the R&S NGP800 user documentation. You can find it on the product page at:

www.rohde-schwarz.com/product/ngp800

Getting Started

Introduces the R&S NGP800 power supply series and describes how to set up and start working with the instrument. The printed document is delivered with the instrument.

User manual

The user manual contains the description of all instrument modes and functions. It also provides an introduction to remote control, a complete description of the remote control commands with programming examples, and information on maintenance, instrument interfaces and error messages.

The online version (html format) of the user manual provides the complete contents for immediate display on the internet.

Service manual

Describes the performance test for checking the rated specifications, module replacement and repair, firmware update, troubleshooting and fault elimination, and contains mechanical drawings and spare part lists. The service manual is available for registered users on the global Rohde & Schwarz information system (GLORIS, <https://gloris.rohde-schwarz.com>).

Basic safety instructions

Contains safety instructions, operating conditions and further important information. The printed document is delivered with the instrument.

Datasheet

The datasheet contains the technical specifications of the R&S NGP800 power supply series. It also lists all options with their order numbers and accessories.

See www.rohde-schwarz.com/brochure-datasheet/ngp800

Calibration certificate

The document is available on <https://gloris.rohde-schwarz.com/calcert>. You need the device ID of your instrument, which you can find on a label on the rear panel.

Release notes and open source acknowledgment (OSA)

The release notes list new features, improvements and known issues of the current firmware version, and describe the firmware installation. The open source acknowledgment document provides verbatim license texts of the used open source software.

See www.rohde-schwarz.com/firmware/ngp800.

2 Welcome to R&S NGP800

The two or four-channel power supply series are based on a primary switched-mode regulator with power factor correction. This concept allows the instrument to achieve highest accuracy and lowest residual ripple.

The R&S NGP800 power supply series feature galvanically isolated, overload and short-circuit proof outputs. The outputs can be connected in parallel and serial to achieve higher currents or voltages.

Multi-purpose protection functions, such as overcurrent protection (OCP), overvoltage protection (OVP) and overpower protection (OPP) can be set separately for each channel. If the set limit is reached, the affected output channel is automatically turned off and an indicator icon (🔴, 🟡, 🟢) flashes on the display. The overcurrent protection can also be linked to the other channels. If the current exceeds the limit on the affected channel, all linked channels will be switched off.

The R&S NGP800 power supply series are also protected from overheating. Each channel is equipped with a temperature sensor that monitors the channel operating temperature for controlling the fan speed and overtemperature protection. If the safe limit is exceeded, the output of the affected channel is switched off. The channel must cool down to a defined threshold before the output can be switched on again. Operations of the other channels are not affected. Also, the actual operating speed of the fans is monitored. If a fan is not running, e.g. rotor locked condition, all the outputs will be switched off to prevent overheating.

The R&S QuickArb function allows freely definable voltage and current sequences with a timeframe as short as 1 ms, e.g. to simulate different charging conditions of a battery. The voltage and current points can also be grouped in different blocks which can be sequenced and repeated independently to achieve a flexible arbitrary function generation.

With the R&S EasyRamp function, the R&S NGP800 power supply provides the operating condition to ramp up the supply voltage within a defined timeframe up to 10 s with 1 ms step size and it can be set independently for each channel. Furthermore, the channels can be sequenced to ramp up the voltage output applied at different times. With different slew rates and delays between channel outputs, it is easy to test multi-voltage systems reliability. For the four-channel power supplies, the outputs can also be arranged into two independent subgroups.

The analog input and digital I/O interfaces at the rear panel can be activated with an option key. The analog input allows you to control the output directly using voltage signals (0 V to 5 V analog input corresponds to 0 to V_{max} or I_{max}) and can be set independently for each channel. The analog inputs are galvanically isolated from the channel outputs, making the connection simpler. The digital I/O provides an 8-bit control port for various control functions. Each pin can be configured as input or output port, to control any output channel, trigger an event, e.g. start arbitrary or to indicate various conditions, e.g. over current protections.







The R&S NGP800 power supplies are equipped with a color 800 x 480 5" TFT LCD touch screen and a USB and LAN interfaces to control the instrument remotely. With wireless LAN (WLAN) option, network connection can also be established wirelessly.

The R&S NGP800 power supplies can also be remote controlled using the GPIB option.

The user manual describes all instrument functionalities. The latest version is available for download from the product homepage (<http://www.rohde-schwarz.com/product/ngp800>).

3 Important Notes

3.1 Symbols

	Caution, general danger zone
	Ground
	PE terminal
	ON (supply voltage)
	OFF (supply voltage)
	Ground terminal

3.2 Ambient Conditions

The allowed operating temperature ranges from +5 °C to +40 °C (pollution category 2). The maximum relative humidity (without condensation) is at 80 %.

During storage and transport, the temperature must be between -20 °C and +70 °C. In case of condensation during transportation or storage, the instrument requires approximately two hours to dry and reach the appropriate temperature prior to operation. The instrument is designed for use in a clean and dry indoor environment. Do not operate with high dust and humidity levels, if danger of explosion exists or with aggressive chemical agents.

Any operating position may be used; however adequate air circulation must be maintained. For continuous operation, a horizontal or inclined position (integrated stand) is preferable.

Specifications with tolerance data apply after a warm up period of at least 30 minutes at a temperature of 23 °C (tolerance -3 °C / + 7 °C).

The heat produced inside the instrument is guided to the exterior via temperature-controlled fan. Each channel has multiple temperature sensors which check the heat generation in the instrument and control the fan speed.

It is necessary to ensure that there is sufficient space around the instrument sides for heat exchange. If the temperature inside the instrument increases more than the

allowed limit, overtemperature protection is triggered and the affected outputs is switched off automatically.

⚠ CAUTION**Air circulation**

Do not obstruct the ventilation holes!

3.3 Measurement Categories

This instrument is designed for supplying power on circuits that are only indirectly connected to the low voltage mains or not connected at all. The instrument is not intended for measurements within the measurement categories II, III or IV; the maximum potential against earth generated by the user must not exceed 250 V peak in this application.

The following information refers solely to user safety. Other aspects, such as the maximum voltage, are described in the technical data and must also be observed.

The measurement categories refer to transients that are superimposed on the mains voltage. Transients are short, very fast (steep) current and voltage variations which may occur periodically and non-periodically. The level of potential transients increases as the distance to the source of the low voltage installation decreases.

- Measurement CAT IV: Measurements at the source of the low voltage installations (e.g. meters)
- Measurement CAT III: Measurements in building installations (e.g. power distribution installations, power switches, firmly installed sockets, firmly installed engines etc.)
- Measurement CAT II: Measurements on circuits electronically directly connected to the mains (e.g. household appliances, power tools, etc.)
- 0 (instruments without measured measurement category): Other circuits that are not connected directly to the mains

3.4 Mains Voltage

The instrument accepts worldwide mains voltage from 100 VAC to 240 VAC, 50 Hz / 60 Hz. No voltage selector switch is required. The instrument is protected by internal fuses which is not user accessible. If the instrument is not powering on, this may indicate an open fuse, the instrument must be sent for servicing. The instrument provides rocker switch at rear panel, which disconnects the AC input. A standby switch at the front panel toggles the instrument operation between normal mode and low consumption power down mode.

NOTICE**Safe operation**

If the instrument is not in use, it must be switched off at the mains switch for safety reasons.

3.5 Limits

The R&S NGP800 is equipped with a protective overload feature. The protective overload feature prevents damage to the instrument and is intended to protect against a possible electrical shock. The maximum values for the instrument must not be exceeded. The protection limits are listed on the front panel of the R&S NGP800 to ensure the safe operation of the instrument.

These protection limits must be adhered to:

Specification	Limits
Maximum output voltage	32 V module: 32 VDC 64 V module: 64 VDC
Maximum output current	32 V module: 20 ADC 64 V module: 10 ADC
Maximum voltage against earth	250 VDC
Maximum counter-voltage (same polarity)	32 V module: 35 VDC 64 V module: 70 VDC
Maximum reverse voltage (opposite polarity)	0.4 VDC
Maximum reverse Current (through protection diode, instrument must be operating)	20 A
AC input	100 VAC to 250 VAC, 50 Hz / 60 Hz
Maximum power output	400W for NGP802 & NGP822 800W for NGP804, NGP814 & NGP824

4 Getting Started

4.1 Putting into Operation

This chapter describes how to set up the R&S NGP800 power supply series for the first time.

WARNING

Risk of injury and instrument damage

The instrument must be used in an appropriate manner to prevent electric shock, fire, personal injury, or damage.

- Do not open the instrument casing
- Read and observe the "Basic Safety Instructions" delivered as a printed brochure with the instrument. Note that the basic safety instructions also contain information on operating conditions that prevent damage to the instrument

In addition, read and observe the safety instructions in the following sections.

Notice that the data sheet may specify additional operating conditions.

WARNING

Risk of radio interference

This instrument is compliant with Class A of CISPR 32. In a residential environment, this instrument may cause radio interference.

NOTICE

Risk of instrument damage during operation

An unsuitable operating site or test setup can cause damage to the instrument and the connected devices. Ensure the following operating conditions before you switch on the instrument:

- The instrument is dry and shows no sign of condensation
 - The instrument is positioned as described in [Chapter 4.1.4.1, "Bench Operation"](#), on page 19
 - The ambient temperature does not exceed the range specified in the data sheet
 - Signal levels at the input connectors are all within the specified ranges
 - Signal outputs are correctly connected and not overloaded
-



EMI impact on measurement results

Electromagnetic interference (EMI) may affect the measurement results.

To suppress the generated EMI:

- Use suitable shielded cables of high quality, for example, LAN cables
- Note the EMC classification in the data sheet

4.1.1 Safety

This instrument was built in compliance with DIN EN 61010-1 (VDE 0411 part 1), safety regulations for electrical instruments, control units and laboratory equipment.

It has been tested and shipped from the plant in safe condition. It is also in compliance with the regulations of the European standard EN 61010-1 and the international standard IEC 61010-1.

To maintain this condition and ensure safe operation, you must observe all instructions and warnings given in this user manual. Casing, chassis and all measuring ports are connected to a protective earth conductor. The instrument is designed in compliance with the regulations of protection class I.

For safety reasons, the instrument may only be operated with authorized safety sockets. The power cable must be plugged in before signal circuits may be connected.

Never use the product if the power cable is damaged. Check regularly if the power cables are in perfect condition. Choose suitable protective measures and installation types to ensure that the power cable cannot be damaged and that no harm is caused by tripping hazards or from electric shock, for instance.

DANGER

Risk of electric shock

It is prohibited to disconnect the earthed protective connection inside or outside of the instrument!

If it is assumed that a safe operation is no longer possible, the instrument must be shut down and secured against any unintended operation.

Safe operation can no longer be assumed when:

- Instrument shows visible damage
- Instrument includes loose parts
- Instrument no longer functions properly
 - After an extended period of storage under unfavorable conditions (e.g. outdoors or in damp rooms)
 - After rough handling during transport (e.g. packaging that does not meet the minimum requirements by post office, railway or forwarding agency)

⚠ DANGER**Exceeding the low voltage protection**

Use insulated wires and not bare wires for the terminal connection.

It is assumed that only qualified and trained personnel service the power supplies and the connected loads.

The universal AC input at the rear of the instrument accepts nominal line voltages in the range of 100 VAC to 250 VAC. Line frequency can be either 50 Hz or 60 Hz.

Fuses

The instrument contains internal fuses, which are not user accessible.

4.1.2 Intended Operation

The instrument is intended only for use by personnel familiar with the potential risks of measuring electrical quantities.

For safety reasons, the instrument may only be connected to properly installed wall outlets. Separating the ground is prohibited.

The power cable must be inserted before signal circuits may be connected.



Use only the power cable included in the delivery package. See "[Delivery package](#)" on page 18.

Before each measurement, measuring cables must be inspected for damage and replaced if necessary. Damaged or worn components can damage the instrument or cause injury.

The instrument may be operated only under the operating conditions and in the positions specified by the manufacturer, without the product's ventilation being obstructed. If the manufacturer's specifications are not observed, this can result in electric shock, fire and/or serious personal injury, and in some cases, death.

Provide adequate airflow

Do not block the air intake at the front and side of the instrument or the exhaust at the rear. Install the instrument on a location that allows sufficient space for air circulation at the air intake and exhaust. Recommended spacing to non-heat producing surface is at least 2.5 inches (63.5 mm) from the ventilation holes.

Applicable local or national safety regulations and rules for the prevention of accidents must be observed in all work performed.

The instrument is designed for use in the following sectors: Industrial, residential, business and commercial areas and small businesses.

The instrument is designed for indoor use only. Before each measurement, you need to verify at a known source if the instrument functions properly.



To disconnect from the mains, unplug the IEC socket on the back panel.

See [Table 4-1](#) for the general data on the instrument specification. For more information, see the instrument datasheet (P/N: 3609.1927.32).

Table 4-1: General data on instrument specification

General data		
Mains nominal voltage	100 VAC to 250 VAC 50 Hz / 60 Hz	
Maximum input power	650 W for 2 channels 1125 W for 4 channels	
Mains fuses	Internal 16 A 250 V IEC 60127-2/7 fast-acting Not user accessible	
Operating temperature range	+5 °C to +40 °C	
Storage temperature range	-20 °C to +70 °C	
Humidity noncondensing	5 % to 95 %	
Display	TFT 5" 800 pixels x 480 pixels WVGA Touch	
Rack installation	R&S ZZA-GE23 rack adapter 2U (P/N: 5601.4059.00)	
Dimensions (W x H x D)	362 mm x 100 mm x 451 mm (14.25" x 3.94" x 17.76")	
Weight	R&S NGP802/822 (2-channel)	7.5 kg (16.5 lb)
	R&S NGP804/814/824 (4-channel)	8.0 kg (17.6 lb)

4.1.3 Unpacking and Checking the Instrument

Unpack the R&S NGP800 power supply carefully and check the content of the package.

- Check the equipment for completeness using the delivery note and package contents list for the various items.
- Check the instrument for any damage and loose parts. If there is any damage, immediately contact the carrier who delivered the instrument.



Packing material

Retain the original packing material. If the instrument needs to be transported or shipped later, you can use the material to protect the control elements and connectors.

NOTICE**Risk of damage during transportation and shipment**

Insufficient protection against mechanical and electrostatic effects during transportation and shipment can damage the instrument.

- Always ensure that sufficient mechanical and electrostatic protections are provided
- When shipping an instrument, the original packaging should be used. If you do not have the original packaging, use sufficient padding to prevent the instrument from moving around inside the box. Pack the instrument in antistatic wrap to protect it from electrostatic charging
- Secure the instrument to prevent any movement and other mechanical effects during transportation

Delivery package

The package contents contain the following items:

- R&S NGP800 power supply
- Four power cables
- Two 8-pin terminal block plug for output connections
- Two 8-pin plug for analog Input and digital I/O port connections
- One printed Getting Started manual
- One document folder containing a Basic Safety Instructions guide, calibration certificate, KC and CE certificate

4.1.4 Setting Up the Instrument

The R&S NGP800 power supply series are designed for benchtop and rackmount operation.

NOTICE**Risk of instrument damage due to high temperature**

Operate R&S NGP800 power supply in an area where the ambient temperature is within +5 °C to +40 °C.

The R&S NGP800 power supply is fan-cooled and must be installed with sufficient space on the sides to allow proper air circulation. Ensure that fan openings are unobstructed and airflow vents are unimpeded.

Operating the instrument with insufficient airflow or outside the allowable ambient temperature can disrupt the operation and even cause damage.

4.1.4.1 Bench Operation

On a benchtop, the R&S NGP800 power supply can either lie flat or stand on its feet. As shown in [Figure 4-1](#), feet on the bottom can be folded out to set the instrument in an inclined position.



Figure 4-1: Inclined position

NOTICE

Positioning of instrument

The instrument must be positioned in a manner that allows you to disconnect the unit from the mains at any time and without restrictions.

⚠ WARNING

Risk of injury if feet are folded out

The feet can fold in if they are not folded out completely or if the instrument is shifted. Collapsing feet can cause injury or damage the instrument.

- Fold the feet completely in or out to ensure stability of the instrument. Never shift the instrument when the feet are folded out.
 - When the feet are folded out, do not work under the instrument or place anything underneath.
 - The feet can break if they are overloaded. The overall load on the folded-out feet must not exceed 250 N.
-

4.1.4.2 Rack Mounting

The instrument can be installed in 19" rack using the rack adapter R&S ZZA-GE23 (P/N 5601.4059.00). Proceed according to the installation instructions supplied with the rack adapter.

4.2 Instrument Tour

This chapter provides an overview of all the controls available in the R&S NGP800 power supply series and steps to switch on the instrument for the first time.

- [Overview of Controls](#).....20
- [Switching On the Instrument](#).....24

4.2.1 Overview of Controls

4.2.1.1 Front Panel

The front panel of the R&S NGP800 power supply is shown in [Figure 4-2](#). The function keys and navigation controls are located beside the display. The various connectors are located at the right of the display.

The following power supply models are available:

Table 4-2: Power supply models

Models	Number of output channels
NGP802, NGP822	2
NGP804, NGP814, NGP824	4

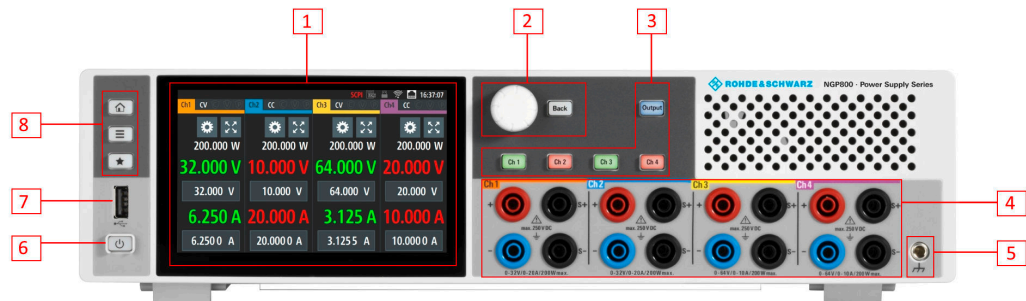

Figure 4-2: Front panel of R&S NGP800 power supply

- 1 = Display with touch screen
- 2 = Rotary knob and back key
- 3 = Output and channel keys
- 4 = Output terminals (see [Table 4-2](#))
- 5 = Chassis ground terminal (4mm socket)
- 6 = Standby button
- 7 = USB connector
- 8 = Menu control keys

Display (1)

The display is a color TFT touch screen. Depending on the instrument models, up to four channels are shown on the display. The respective measurement settings and menu settings are displayed in the individual channel display area.

Two information status bars, providing the overall device operating mode and channel settings of the instrument are located respectively at the device level (top-right hand corner of the display area) and channel level (on top of individual channel display area) of the instrument.

For a detailed description on-screen layout, see section "Display Overview" in the User Manual.

Rotary knob and back key (2)

The rotary knob and back key are used for menu navigation and value adjustment in the instrument.

For a detailed description on navigation, see section "Rotary Knob and Back Key" in the User Manual.

Output and channel keys (3)

Depending on the instrument models, up to four channels and one output key are provided to select individual channel and enable/disable the output(s).

Output terminals (4)

Two-channel instruments: NGP802 and NGP822 are equipped with 8 terminals for outputs and remote sense connections. Four-channel instruments: NGP804, NGP814 and NGP824 are equipped with 16 terminals for outputs and remote sense connections.

For 32 V models, each output is capable to source 200 W of power at 0 V to 32 V and maximum current of 20 A.

For 64 V models, each output is capable to source 200 W of power at 0 V to 64 V and maximum current of 10A.

Chassis ground terminal (5)

A 4 mm socket is provided for the user to connect to earth ground through the instrument ground/chassis.

Standby button (6)

The [Power] key toggles the instrument between standby state and normal state. In standby state, the key is illuminated in red and the instrument internal circuits are operated in powered down state. In normal state, all the internal modules are powered up and the instrument will startup to operate normally. The LED illumination is turned off in this state.

USB connector (7)

USB Type-A connector is provided for connecting a USB flash drive to perform software update, store logging data or screen captures. It can also be used for an external USB mouse connector.

Menu control keys (8)

The menu control keys allow you to access the home window, main menu window and user button key in the instrument.

For a detailed description on menu control keys, see section "Menu Controls" in the User Manual.

4.2.1.2 Rear Panel

Figure 4-3 shows the rear panel of the R&S NGP800 power supply with its connectors.

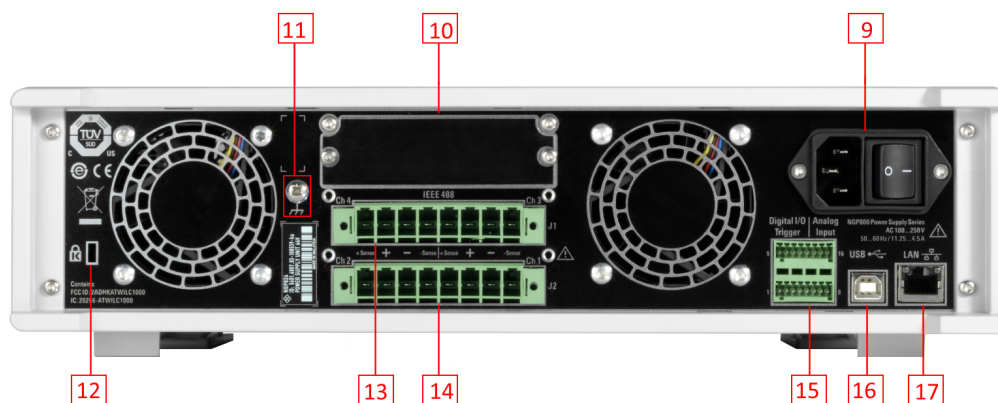

Figure 4-3: Rear panel of R&S NGP800 power supply

- 9 = AC inlet with integrated 2-pole rocker switch
- 10 = Optional IEEE-488 (GPIB) interface
- 11 = Ground terminal
- 12 = Kensington lock
- 13 = Channel 3 and 4 rear panel connector (for NGP804, NGP814 and NGP824 models only)
- 14 = Channel 1 and 2 rear panel connector
- 15 = Analog input and digital I/O connector
- 16 = USB-B connector (device)
- 17 = Ethernet (LAN) connector

AC inlet with integrated 2-pole rocker switch (9)



Main supply cable

Use only the power cable that was supplied with the instrument. Using other types, which might have inadequate rating can cause overheating of the power cable, resulting in fire.

The power cable provides the earth ground connection through the third ground conductor. Operate the instrument only on authorized safety sockets which provide earth connection.

The power cable must be plugged in before signal circuits can be connected. Never use the product if the power cable is damaged.

The built-in 2-pole rocker switch is the main power switch of the instrument which connects/disconnects it from the AC supply.

Option IEEE-488 (GPIB) interface (10)

Option R&S NG-B105 provides an IEEE-488 (GPIB) bus interface.

Ground terminal (11)

M4 screw provides connection to earth ground through the instrument ground/chassis.

Kensington security slot (12)

A Kensington lock can be anchored to the R&S NGP800 power supply housing to secure it to a workstation mechanically.

Channel connectors (13, 14)

NOTICE

Output terminals

Either the channel output terminals at the front panel or rear panel can be used. Using both terminals at the same time can cause instrument malfunction.

The channel terminal blocks contain connections to both outputs (“+”, “-”) and remote sense (“+Sense”, “-Sense”). Terminal block for channel 3 and channel 4 are only available for a 4-channel instrument.

Digital I/O & analog input connector (15)

A 16-pin terminal block provides connection to both digital I/O (option NGP-K103) and analog input (option NGP-K107). See [Figure 4-4](#) for pin assignment of the terminal block.

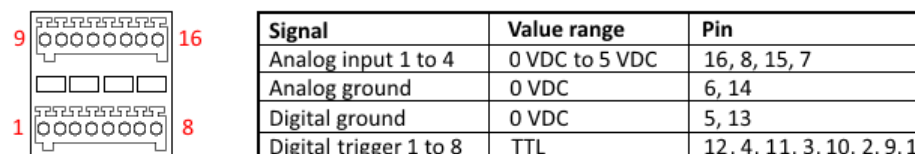

Figure 4-4: Digital I/O & analog input connector pin layout

USB connector (16)

USB Type-B connector provides remote control operation via USB.

Ethernet connector (17)

10/100 Ethernet port for remote control operation via the local area network.

4.2.2 Switching On the Instrument

Before switching on the instrument, check that all the instructions in the “Basic Safety Instruction” brochure and safety measures in previous sections are observed.

To switch on instrument:

1. Connect the power cable to the AC power connector at the rear panel of the R&S NGP800 power supply.
2. Connect the power cable to the socket outlet.
3. Toggle the power rocker switch at the rear panel to turn on the instrument.
The instrument performs a system check, boots the operating system, and starts the R&S NGP800 power supply firmware.

It takes a few seconds for the power supply to complete the initialization before it is ready for use. If the instrument does not turn on, verify that the power cord is securely plugged-in and power is available at the outlet. Check if the standby power is lit at the [Power] key on the front panel. If the standby power is lit, press the [Power] key to initiate the start-up sequence.

To switch off instrument:

1. Press the [Power] key.
The R&S NGP800 power supply initializes the power down sequence and enters into standby mode. The R&S NGP800 operates at low power.
2. Toggle the rocker switch at the rear panel to turn off the instrument completely.
3. Disconnect the AC power cable from the socket outlet.

4.3 Trying Out the Instrument

This chapter describes some basic functions that you can perform with the R&S NGP800 power supply series.

4.3.1 Setting the Output Voltage and Current Limit

1. Press [Home]  key.
The R&S NGP800 power supply displays the home window.

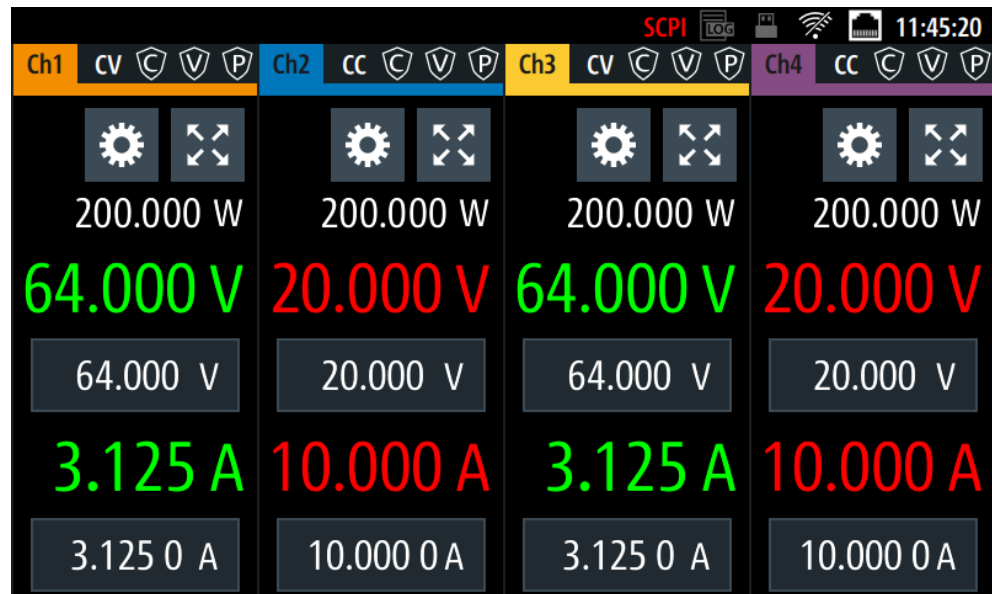

- Select voltage or current parameter of the desired channel.
The R&S NGP800 power supply displays an on-screen keypad to set the value.

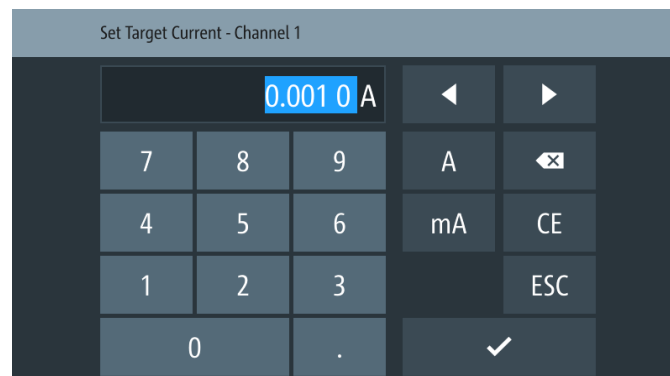

- Enter the required value.
- Confirm value with either a unit key or enter key .
The home window shows the updated voltage and current settings (See changes of voltage and current values in channel 1).

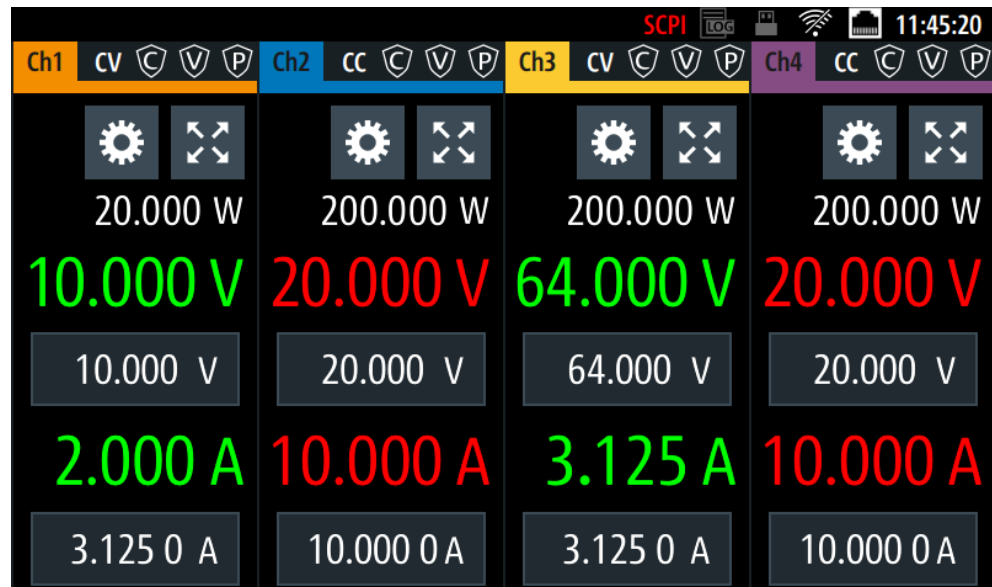

5. Repeat for other channel if desired.

4.3.2 Activating the Channels Output

The output voltages can be switched on or off regardless of the instrument's operating mode.

To activate the channel output, press the [Output] key on the front panel followed by the desired channel key or vice versa.

The R&S NGP800 power supply displays the actual voltage on the output channel and the actual current drawn by the load connected to the output. The display font color of the selected channel changes depending on the operating mode of the instrument.

- Constant voltage (CV)
 - Voltage regulated, actual current is lesser than setpoint.
 - Font color of measured voltage and current is green.
- Constant current (CC)
 - Current regulated, current drawn by the circuit is limited to setpoint.
 - Font color of measured voltage and current is red.

When output is turned off, the display font color changes to white and the operating mode is not displayed.

See the highlighted areas in [Figure 4-5](#).

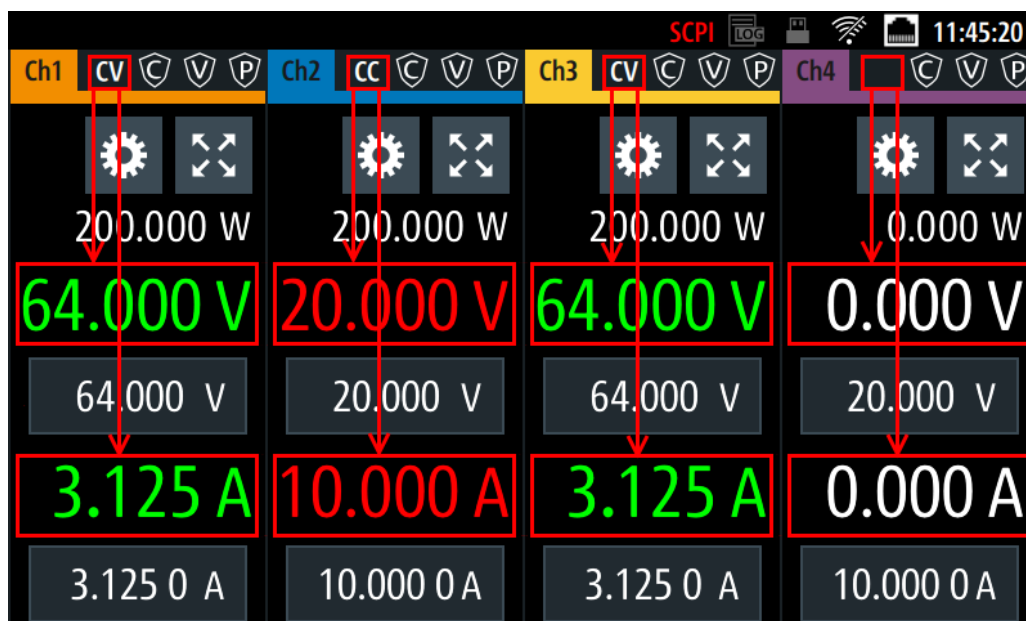

Figure 4-5: Font color in highlighted areas changes to green or red depending on the different operating modes of the instrument

4.4 Maintenance

Regular maintenance improves the life span of the instrument, the following chapter provides information on instrument maintenance.

Cleaning

Before cleaning the instrument, ensure that it has been switched off and the power cable is disconnected.

Clean the outer case of the instrument at regular intervals, using a soft, lint-free dust cloth.

NOTICE

Instrument damage caused by cleaning agents

Use a dry, lint-free cloth to clean the product. When cleaning, keep in mind that the casing is not waterproof. Do not use any liquids for cleaning.

Cleaning agents, solvents (thinners, acetone), acids and bases can damage the front panel labeling, plastic parts and display.

The display may only be cleaned with an appropriate glass cleaner. Rub the display with a dry, clean and lint-free cloth. Do not allow cleaning fluid to enter the instrument.

Internal battery replacement

An internal CR2032 coin cell battery powers the real-time clock circuit which provides continuous time stamp for the instrument. If the battery fails, the system clock and time stamp for the logging function are not available but other instrument functions are not affected.

Under normal usage at room temperature, the battery is expected to last up to 10 years. However, the battery life expectancy is reduced if the device is stored at temperature above 40°C for an extended period of time.



If the instrument cannot retain the date and time settings after turning off the AC input, the battery is discharged.

Contact your local service partner for battery replacement.

5 Operating Basics

5.1 Display Overview

The following displays the home window of R&S NGP800. It shows the output voltage and current level, status bar information and control settings of the instrument.

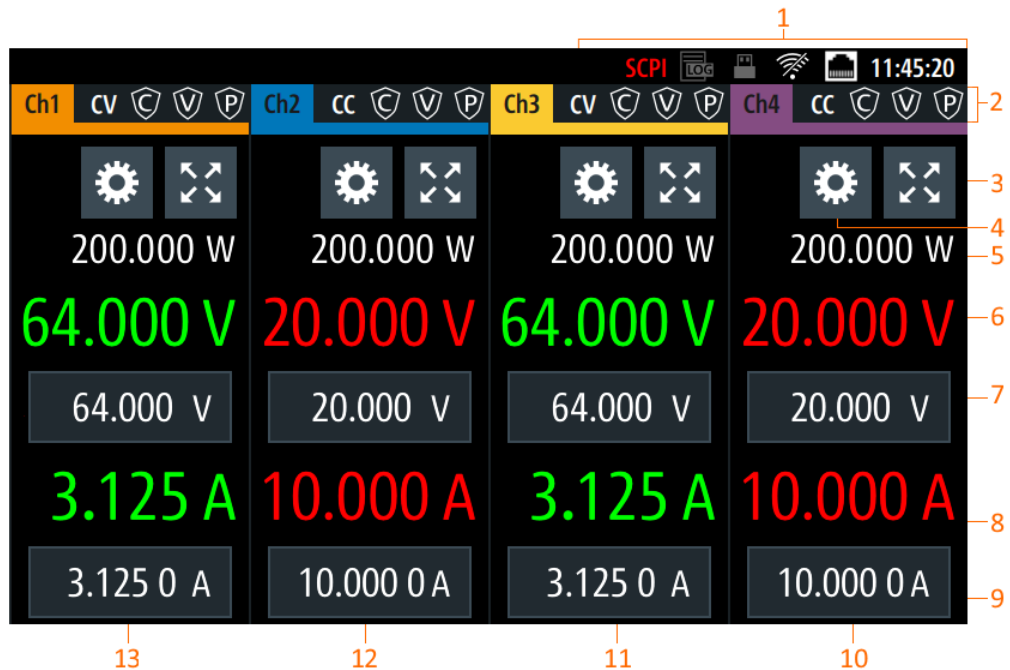

Figure 5-1: Home window of R&S NGP800 with 4 channels

- 1 = Device status bar
- 2 = Channel status bar
- 3 = "Expand/Collapse" channel button
- 4 = "Settings" button
- 5 = Measured output power
- 6 = Output voltage level
- 7 = Set output voltage
- 8 = Measured output current
- 9 = Set output current limit
- 10 = Channel display area of Ch4
- 11 = Channel display area of Ch3
- 12 = Channel display area of Ch2
- 13 = Channel display area of Ch1

5.1.1 Status Bar Information

There are two types of status bar. One shows device status information and the other one shows the individual channel status information.









Device status bar



Function	Description
Touchscreen	If touch input is disabled, the icon is displayed and highlighted in yellow. See Chapter 5.3.1.3, "User Key" , on page 40.
SCPI command	If a SCPI command is received successfully, the icon blinks once in white. If an error is in the SCPI error queue, the icon is highlighted in red. If no activity, icon is displayed in gray.
Trigger event	Icon blinks once in white when a trigger event occurs. See Chapter 6.6, "Digital Trigger I/O" , on page 54.
Data logging	If data logging is present, the icon is highlighted in white. If an error is present, the icon is highlighted in red. See Chapter 6.10, "Data Logging" , on page 63.
USB	If USB device is busy, the icon is highlighted in white. If USB device is idle, the icon is highlighted in gray.
WLAN	Only visible if software option Wireless LAN is active. If connection is present, the icon is highlighted in white. If both WLAN and LAN connection are present, the icon is highlighted with a line cross over. If no connection or WLAN is disabled, the icon is highlighted in gray. See Chapter 6.14.1.2, "Wireless LAN Connection" , on page 73.
LAN interface	If connected, the icon is highlighted in white. If no connection or an error is present in connection, the icon is highlighted in red. See Chapter 6.14, "Interfaces" , on page 69.
Time	Time displays in hh:mm:ss format. See Chapter 6.15.4, "Date and Time" , on page 79.

Channel status bar



Function	Description
Channel number	Channel number indication.
Operation mode	The R&S NGP800 has two operating modes: <ul style="list-style-type: none"> • CV: Constant voltage mode • CC: Constant current mode See Chapter 5.5, "Operation Modes" , on page 42.
OCP 	If enabled, the icon is highlighted in white. If triggered, the icon blinks. See Chapter 6.4.1, "Over Current Protection (OCP)" , on page 50.
OVP 	If enabled, the icon is highlighted in white. If triggered, the icon blinks. See Chapter 6.4.2, "Over Voltage Protection (OVP)" , on page 50.
OPP 	If enabled, the icon is highlighted in white. If triggered, the icon blinks. See Chapter 6.4.3, "Over Power Protection (OPP)" , on page 51.
Arbitrary mode 	If enabled, the icon is highlighted in white. If active, the icon blinks. See Chapter 6.7.1, "QuickArb" , on page 57.
Ramp mode 	If enabled, the icon is highlighted in white. If active, the icon blinks. See Chapter 6.7.2, "EasyRamp" , on page 60.
"Safety Limits" 	If enabled, the icon is highlighted in white. See Chapter 6.4.4, "Safety Limits" , on page 52.
"Output Delay" 	If enabled, the icon is highlighted in white. The delay is the time between activation of the output and applying voltage to the output. See Chapter 6.2.1, "Output" , on page 45.
Calibration mode 	If user adjustment is active, the icon is highlighted in red. See Chapter 6.16, "Adjustment" , on page 81.
Sense connection 	If sense connection is detected, the icon is highlighted in white. See Chapter 6.2.1, "Output" , on page 45.
Tracking 	If tracking is enabled, the icon is highlighted in white. See Chapter 6.5, "Tracking Function" , on page 53.

5.1.2 Channel Display Area

The R&S NGP800 displays four channels display area (Ch 1, Ch 2, Ch 3, Ch 4) for NGP804, NGP824, NGP814 and two channels display area (Ch 1, Ch 2) for NGP802, NGP822. The respective channel settings and functions are displayed for each channel.



Figure 5-2: Channel display area for 4-channel model

- 1 = Output power displays in watt
- 2 = "Settings" button opens instrument main menu window
- 3 = "Expand/Collapse" button toggles between home window and channel overview window
- 4 = Output voltage displays in volt. The display resolution for voltage is three digits after the decimal point
- 5 = Set voltage level.
- 6 = Output current displays in ampere. The display resolution for current is four digits after the decimal point
- 7 = Set current level.

Operating mode

Different font colors on the screen are used to differentiate the various output status and operating condition of the instrument. It is easy to know and confirm the different output status and operating conditions of the instrument by looking at the colors.

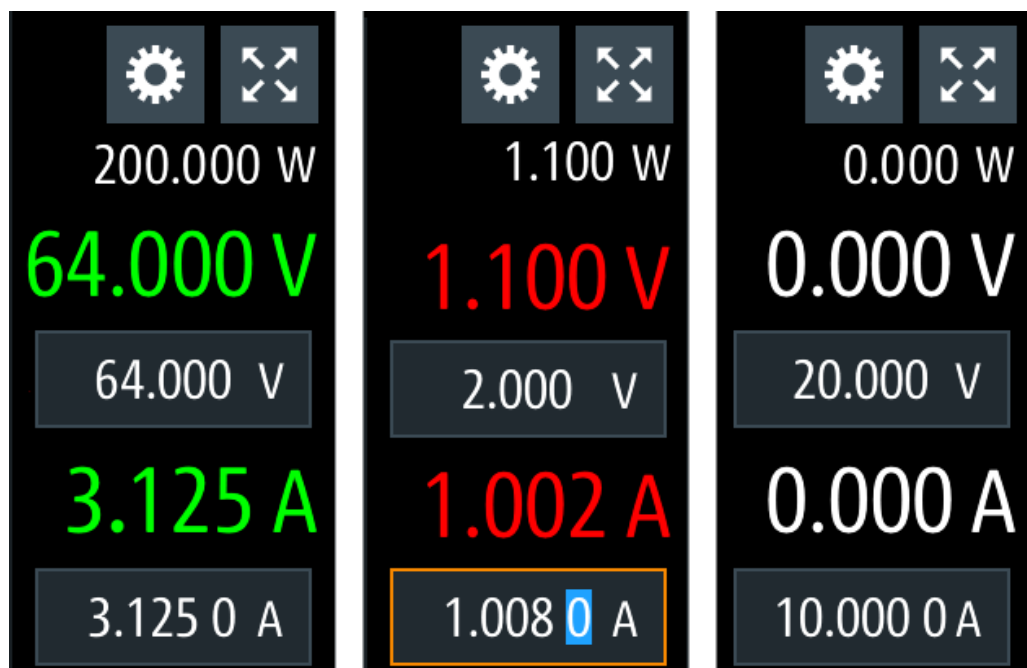

Figure 5-3: Color coding of operating conditions

Color	Operating mode	Description
□	OFF mode	Output is OFF
■	Editing mode	A solid blue cursor is shown when an item is selected.
■	CV mode	Active outputs are operated in a constant voltage mode.
■	CC mode	Active outputs are operated in a constant current mode.

5.2 Using the Touchscreen

The R&S NGP800 provides a touch-sensitive screen. Touch can be disabled (see [Chapter 6.8, "User Key"](#), on page 61) in the instrument settings. The following illustrates the touchscreen gestures and highlights the different touchscreen features that can be performed on the instrument.

5.2.1 Using Gestures



Tap

Tap on the screen to select or toggle the value.



Swipe up and down

Swipe up to scroll down, swipe down to scroll up in the menu.

5.2.2 Accessing Functionality in the Home Window

The following illustrates various ways of accessing functions in the home window.

5.2.2.1 Settings Button

The "Settings" button navigates to the device/channel menu window where you can set device or individual channel settings on the instrument.

1. Select the "Settings" button.
The R&S NGP800 displays device/channel menu window.
2. Select "Device" or respective channel tab ("Ch 1", "Ch 2", "Ch 3" or "Ch 4") to open the menu.
3. Swipe up or down for the available items in the menu.
4. Select the required item to configure the settings.
5. Select the back arrow key or press [Back] key to close the menu.



Figure 5-4: Navigation on home window > device/channel menu window

5.2.2.2 Voltage and Current Inputs

You can directly change the voltage and current level in the respective channel display area.

1. Select the voltage or current field in the channel display area to set value.
The R&S NGP800 displays the on-screen keypad to enter value.
2. Set the required value.
See [Chapter 5.2.3, "Input Data"](#), on page 36.
Note: The value is set within the value configured in the "Safety Limits" dialog.
3. Confirm value by selecting a unit key.
Alternatively, select the enter key  to confirm your value.

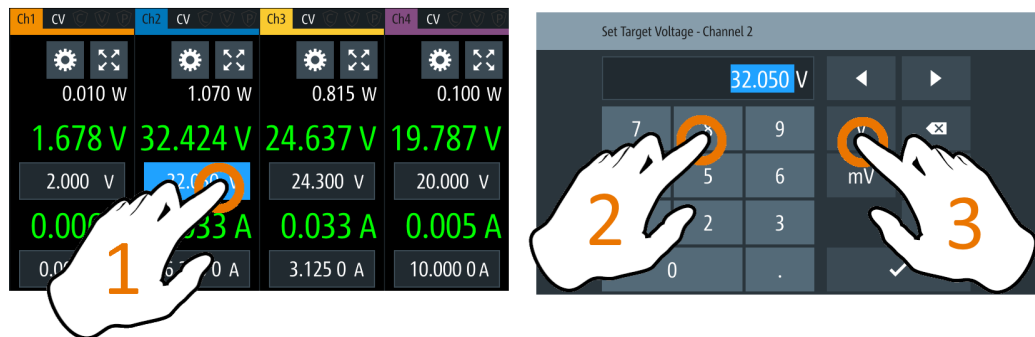

Figure 5-5: Set voltage and current in home window

5.2.2.3 Expand/Collapse Button

You can expand the selected channel window by using the "Expand/Collapse" button. The "Expand/Collapse" icon changed when toggled.

1. Select the "Expand/Collapse" button.
The R&S NGP800 expands the selected channel to the full screen.
2. Select the "Expand/Collapse" button to revert to the home window.

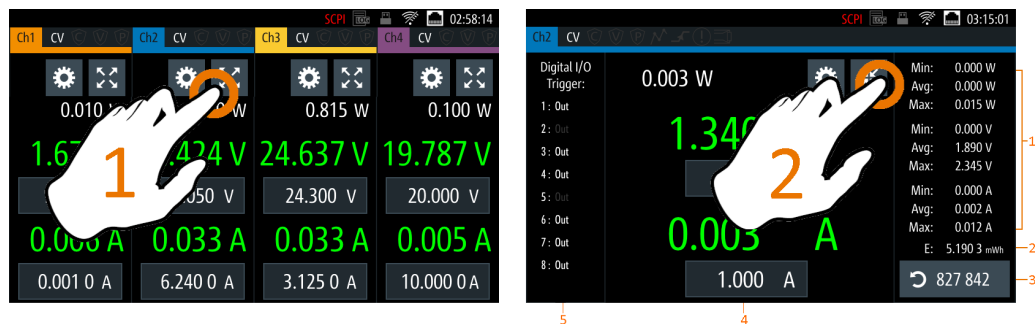



Figure 5-6: Display of channel overview window

- 1 = Minimum, maximum and average value for power, voltage and current
- 2 = Calculation of energy result
- 3 = Number of samples collected
- 4 = Channel display area of selected channel
- 5 = Digital I/O trigger of selected channel

5.2.3 Input Data

The R&S NGP800 provides an on-screen keypad for you to enter numerical values. Use the back key  on the on-screen keypad to cancel input of the numerical entries.

1. Select a menu item to enter the numeric value.
The R&S NGP800 displays the on-screen keypad.
2. Enter the required value.
3. Confirm value with the unit key.
Alternatively, select the enter key  to confirm your value.

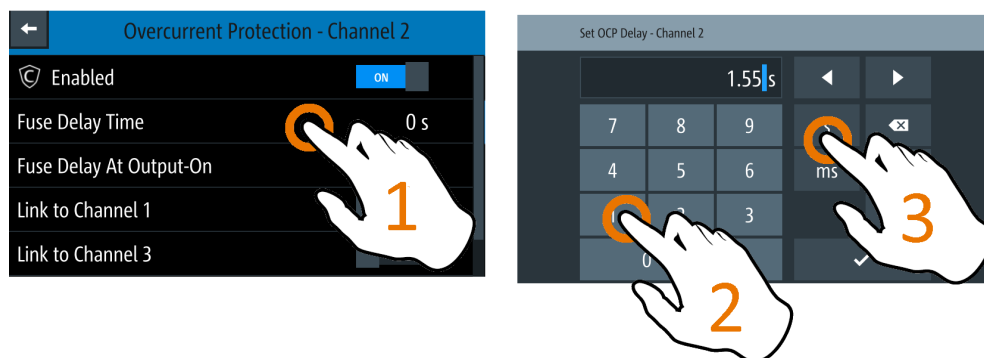



Figure 5-7: Enter numerical value and unit

For alphanumeric input, the on-screen keypad works the same way.

1. Select the "Caps Lock"  key to switch between capital letters and small letters.
The "Caps Lock" key is highlighted in blue.
2. Select "&123" or "ABC" key to switch between alphabet and numeric input data.

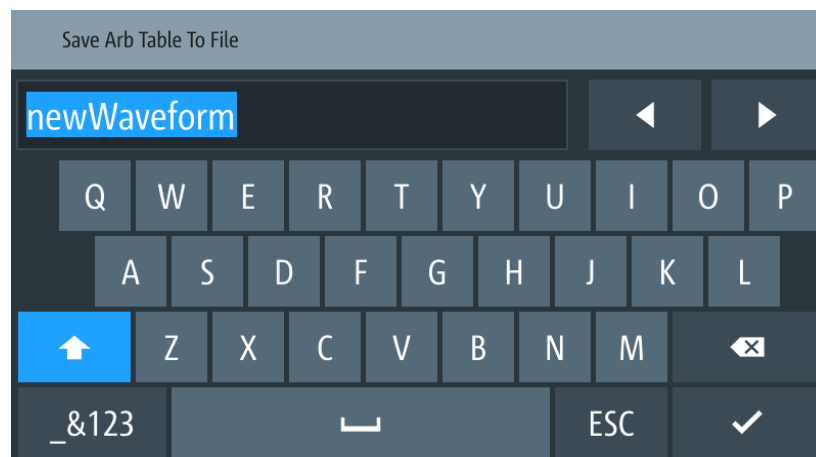

Figure 5-8: Alphanumeric input data

5.3 Front Panel Keys

For an overview of the front panel keys, see [Figure 4-2](#).

5.3.1 Menu Controls

The menu controls keys provide navigation on the available menus in the instrument.

5.3.1.1 Home Key



The [Home] key navigates to the instrument home window. See the display of the home window in [Figure 5-1](#).

5.3.1.2 Settings Key



The [Settings] key navigates to the device/channel menu window which consists of the "Device" menu and depending on the instrument variants, either two or four channels ("Channel 1", "Channel 2", "Channel 3", "Channel 4") menu.

Device menu

The "Device" menu provides access to general instrument settings, file arrangement and user key configuration. You can also obtain the instrument information via the menu.

1. Press [Home] key.
The R&S NGP800 displays the home window.
2. Select the "Settings" button on the required channel display area.

Alternatively, press [Settings] key.

3. Select the "Device" tab to access the device menu.

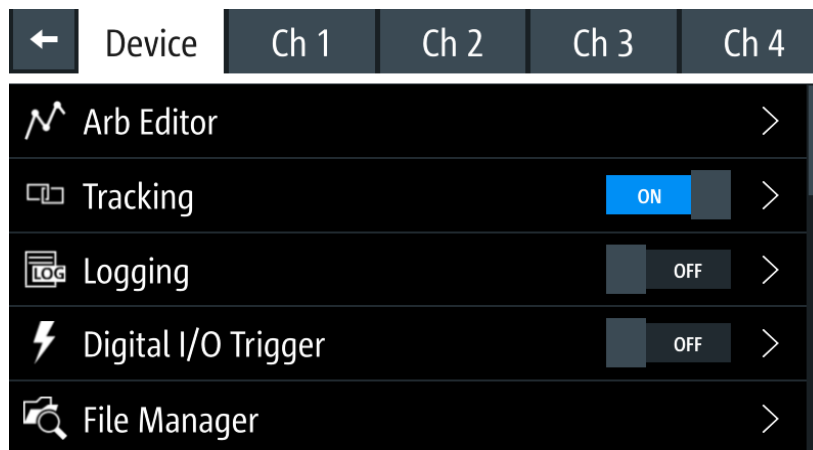

Figure 5-9: Device menu

Menu	Description
"Arb Editor"	Programs the waveform of voltage and current settings for the channel output.
"Tracking"	Changes made on voltage and current are applied to the tracked channels.
"Logging"	Data logging on the instrument timestamp, voltage, current and power.
"Digital I/O Trigger"	Available only with option R&S NGP-K103 Configures the digital I/O pins trigger modes and its associated settings.
"File Manager"	File transfer function between instrument internal memory and USB stick.
"Interfaces"	Wireless LAN is available only with option NGP-K102. IEEE-488 (GPIB) interface is available only with option NG-B105. Configures the network (WLAN, Wireless LAN), USB interface and GPIB address
"User Button"	Configures the shortcut key action (screenshot, trigger, toggle logging, reset statistics, toggle touch).
"Screenshot"	Captures screen image of the instrument.
"CSV Settings"	Configures the file formatting for CSV file.
"Data & Time"	Configures date, time and clock format of the instrument.
"Appearance"	Configures brightness level for screen display and frontpanel keys.
"Sound"	Enables/Disables sound when selected trigger events occur.

Menu	Description
"Licenses"	Displays license information and install license options.
"Device Information"	Displays instrument information.
"Update Device"	Performs firmware update on the instrument.
"Save/Recall Device Settings"	File management on the instrument settings. Resets instrument settings with factory default.
"Analog In Adjustment"	Available only with option NGP-K107. Provides user adjustment to the analog in connector (see "Digital I/O & analog input connector (15)" on page 23). Restore factory adjustment.

Channel menu

The "Ch 1", "Ch 2", "Ch 3" or "Ch 4" menu provides access to settings on channel output, channel trigger conditions and output limit settings.

1. Press [Home] key.
The R&S NGP800 displays the home window.
2. Select the "Settings" button on the selected channel display area.
Alternatively, press [Settings] key to access the required channel menu.

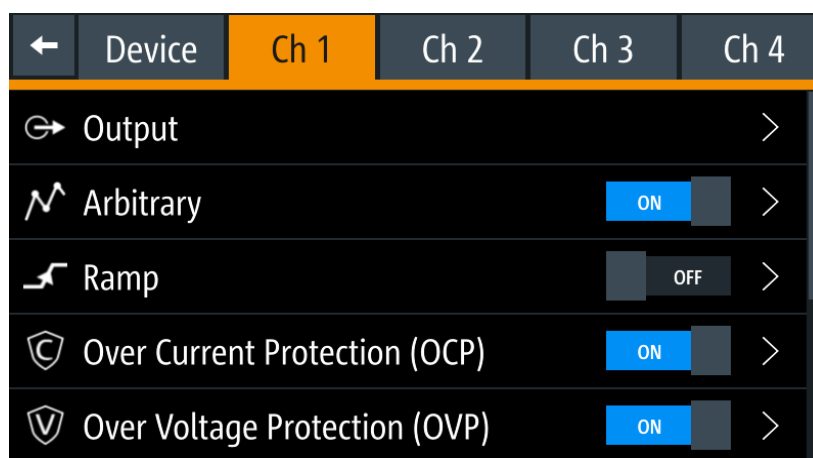

Figure 5-10: Channel 1 menu

Menus	Description
"Arbitrary"	Configures the arbitrary sequence, sequence repeatability response and the sequence ending behavior.
"Ramp"	Configures the ramping time applied on the channel output.
"Over Current Protection (OCP)"	Configures OCP protection settings ("Blowing Delay", "Initial Delay" and linking channel) for the instrument.
"Over Voltage Protection (OVP)"	Configures OVP protection settings (OVP level) for the instrument.

Menus	Description
"Over Power Protection (OPP)"	Configures OPP protection settings (OPP power) for the instrument.
"Analog Input"	Available only with option NGP-K107. Analog input voltage applied at the rear panel is used to regulate the output settings for voltage or current.
"Adjustment"	Available only with option NGP-K107. Perform channel adjustment. Restore factory adjustment.
"Safety Limits"	Configures the voltage and current limit of the channel output.

5.3.1.3 User Key



The [*] key provides a shortcut function to one of the followings:

- screenshot
- trigger
- data logging
- reset statistics
- toggle touchscreen input

The shortcut key is configurable in the "Device">"User Button" menu. See [Chapter 6.8, "User Key"](#), on page 61.

5.3.2 Navigation Controls

Navigation in the menu and setting of values can be done via rotary knob and [Back] key.

Rotary knob



The rotary knob has several functions:

- Increments (clockwise direction) or decrements (counter-clockwise direction) any kind of numeric value when in editing mode
- Navigates up (clockwise direction) or down (counterclock-wise direction) the menu or menu items when rotated
- When pressed and rotated, the rotary knob navigates along the set voltage or current position in the home window

[Back] key

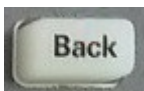

Using the [Back] key, you can do several things:

- Navigate to the previous menu window
- Close or discard changes made on the on-screen keypad
- Close the instrument pop-up messages

5.3.3 Output and Channel Controls

Depending on the instrument models, up to 4-channel keys control the channel output settings of the instrument.



Function keys	Description
[Ch 1], [Ch 2], [Ch 3], [Ch 4]	Selects the respective channel for output.
[Output]	Master output switch - it turns output for all selected channels on or off.

5.4 Output Power Auto Ranging

The R&S NGP800 power supply series provides a maximum output power of 200 W for each channel. Depending on the power supply models, up to 800 W of output power is provided for models with four identical channels with a continuous voltage range of 0 V to 32 V or 64 V.

Combination of the set voltage and current limit results in the following output performance graph.

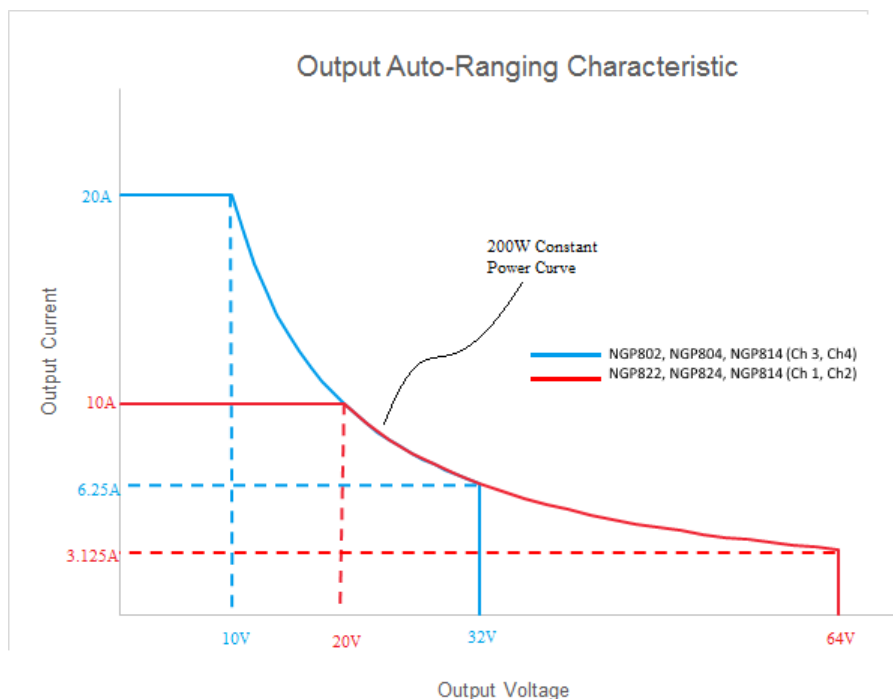

Figure 5-11: Output performance graph

According to the electrical basis formula for power ($P = I \times V$), the following results for the maximum power per channel:

- NGP802, NGP822: 200 W per channel (400 W max for the combination of two channels)

- NGP804, NGP824, NGP814: 200 W per channel (800 W max for the combination of four channels)

5.5 Operation Modes

The R&S NGP800 operates in two modes, i.e. CV and CC. The instrument switches automatically between CV and CC depending on the connected load.

CV mode

Figure 5-12 shows that if the instrument is in the range of voltage regulation, the output voltage V_{out} remains constant while the current may increase to its maximum value I_{max} when the connected load is increasing. In CV mode, the font text in the channel display area changes to green.

See Figure 5-3.

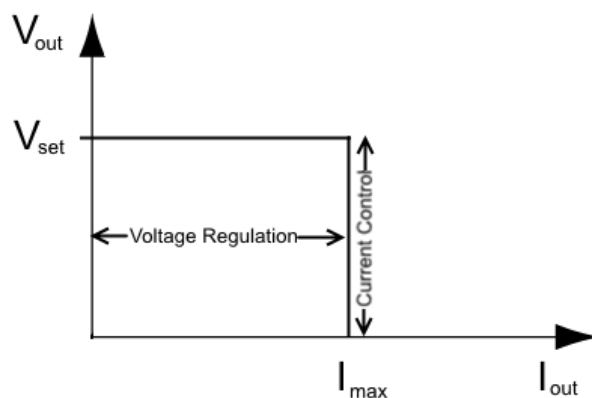

Figure 5-12: Current limit

CC mode

The current I_{max} corresponds to the current setting adjustable in the instrument.

If I_{out} reaches I_{max} , the instrument switches to CC mode, i.e. the output current remains constant and limited to I_{max} even if the load increases. Instead, the output voltage V_{out} decreases to almost zero with a short circuit. In CC mode, the font text in the channel display area changes to red.

See Figure 5-3.

6 Instrument Functions

6.1 Setting the Channels Voltage and Current

The R&S NGP800 comes with the following instrument models:

Models	Channels
NGP802, NGP822	Ch 1, Ch 2
NGP804, NGP824, NGP814	Ch 1, Ch 2, Ch 3, Ch 4

Toggle the respective channel key ([Ch 1], [Ch 2], [Ch 3], [Ch 4]) on the front panel to select these channels. When a channel is selected, the respective channel key illuminates.

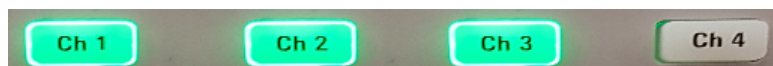

Figure 6-1: Ch 1, Ch 2, and Ch 3 key illuminates when selected

Set output voltage and current



Voltage, current settings

If "Analog input" on page 48 or "Channel settings" on page 57 function of a selected channel is enabled, the respective channel voltage or current setting is disabled.

See "Analog input" on page 48 and "Channel settings" on page 57.

Depending on the instrument models, the R&S NGP800 adjusts the following voltage and current values with a voltage step size of 1 mV and current step size of 0.5 mA.

Model	Voltage	Current
NGP802, NGP804, NGP814 (Ch 1, Ch 2)	0 V to 32.05 V	0 A to 20.01 A
NGP822, NGP824, NGP814 (Ch 3, Ch 4)	0V to 64.05 V	0 A to 10.01 A

The setting of current value corresponds to the I_{\max} of the respective channel. It is advisable to set the current limit before operating the instrument to prevent damage to the load and instrument in the case of malfunction such as a short-circuit.

1. Press [Home] key.
The R&S NGP800 displays the home window.
2. Set voltage or current in the home window.
The R&S NGP800 displays the on-screen keypad to set value.

3. Enter the required voltage or current value.
4. Confirm value with the unit key (V/mV or A/mA).
5. Press the required channel key ([Ch 1], [Ch 2], [Ch 3] or [Ch 4]) on the front panel. The selected channel key is illuminated. See [Figure 6-1](#).
6. Press the [Output] key on the front panel. The R&S NGP800 outputs the set voltage of the selected channel and displays the corresponding values in the home window. For more information on the operation modes, see [Chapter 5.5, "Operation Modes"](#), on page 42.

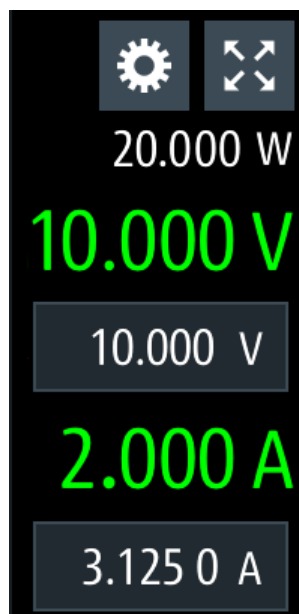

Figure 6-2: Voltage and current settings in the instrument

6.2 Activating the Channels Output

The outputs of all the channels (Ch 1, Ch 2, Ch 3, Ch 4) can be switched on or off by toggling the [Output] key on the front panel.

By default, the output is turned off when the instrument is switched on.

1. Press the required channel key. Selected channel key (Ch 1, Ch 2, Ch 3, Ch 4) illuminates.
2. Press [Output] key. The R&S NGP800 outputs the set voltage of the selected channel. Depending on the operating mode, the font text in the channel display area shows green in CV mode and red in CC mode. See [Chapter 5.5, "Operation Modes"](#), on page 42.

See also [Chapter 5.4, "Output Power Auto Ranging"](#), on page 41.

Multiple outputs can be turned on or off at the same time.

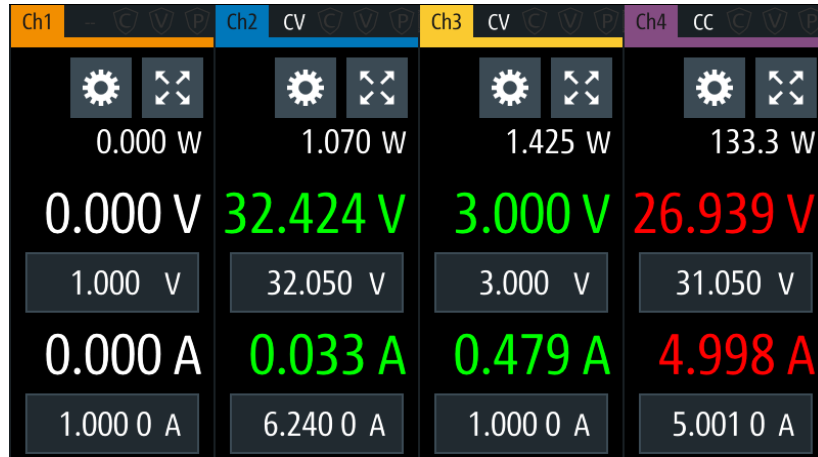

6.2.1 Output



The "Output" menu provides the settings for [output delay](#) and [remote sense](#) mode.

1. Press [Settings] key.
The R&S NGP800 displays the device/channel menu window.
2. Select the required channel tab to apply output delay.
The R&S NGP800 displays the selected channel menu.
3. Select the "Output" menu item.
The R&S NGP800 displays the "Output" dialog.



6.2.1.1 Delay

1. Select the "Delay" menu item to configure the required values.
The R&S NGP800 displays the "Output Delay" dialog.

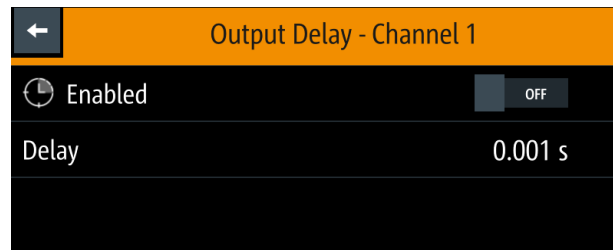

2. Set the required value.
The R&S NGP800 displays the onscreen keypad for entry.
3. Confirm value with the unit keys.

The output delay is the time between the "Output On" event and the available voltage at the output terminals. See [Figure 6-3](#).

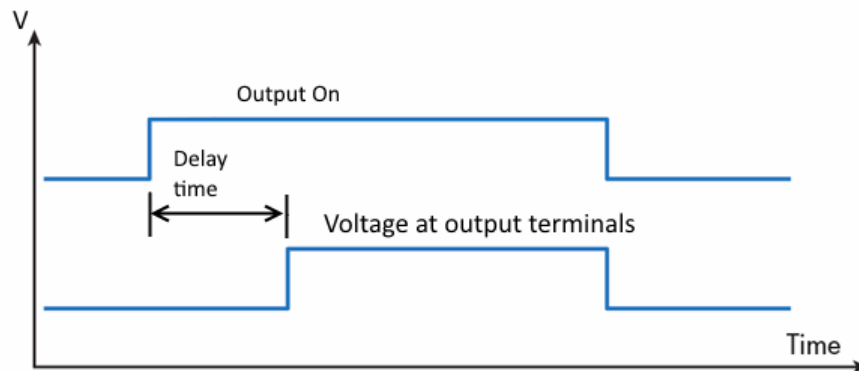

Figure 6-3: Output delay at the output terminals

When the instrument output delay is activated, the front panel of the respective channel key (i.e [Ch 1], [Ch 2], [Ch 3], [Ch 4]) blinks in green and a "DLY" red text is displayed at the channel display area of the respective channel. See [Figure 6-4](#).

These operating behaviors resume to normal after the delay time.



Figure 6-4: Delay text at channel display area

6.2.1.2 Remote Sense



For voltage setting < 1 V, setting of remote sense mode to "EXT" is recommended.

The "Remote Sense" is a mechanism used to monitor and compensate the voltage drops on the cables connected to the load.

1. Select "Remote Sense" menu item to configure the remote sense mode. The R&S NGP800 displays the "Remote Sense" dialog.

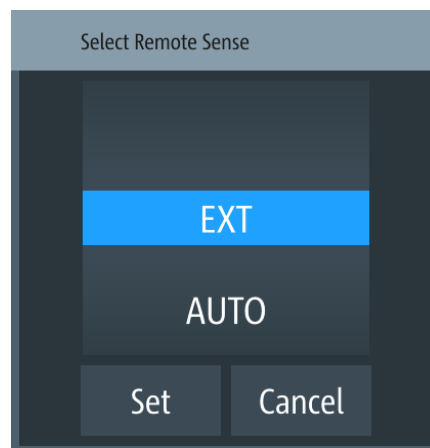

2. Select the required remote sense mode.
 - EXT: The internal voltage sense relay in the instrument is switched on and the connection of remote sense wires (S+, S-) to the input of the load become necessary. Failure to connect remote sense can cause overvoltage or unregu-

lated voltage output from the R&S NGP800. The voltage sense relay remains switched on even when output is turned off.

- AUTO : The detection and enabling of the voltage sense relay automatically kicks in when the connection of remote sense wires (S+, S-) to the input of the load is applied. The voltage sense relay is switched off when output is turned off in this case.

3. Select "Set" to configure the remote sense mode.

6.3 Analog Input



Instrument option

R&S NGP-K107 (P/N: 5601.6200.03) option is required for the "Analog Input".



Analog input

If "Analog Input" of a selected channel (voltage or current) is enabled, the respective channel voltage or current setting is disabled.

See [Chapter 6.1, "Setting the Channels Voltage and Current"](#), on page 43.

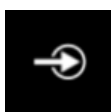

With "Analog Input", you can regulate the channel output (voltage or current) settings with an input voltage of 0 V to 5 V.

Analog input mode	NGP output for 64 V channels	NGP output for 32 V channels
Voltage mode	0 V to 64 V	0 V to 32 V
Current mode	0 A to 10 A	0 A to 20 A

1. Press [Settings] key.
The R&S NGP800 displays the device/channel menu window.
2. Select the required channel tab to configure the analog input mode.
The R&S NGP800 displays the selected channel menu.
3. Select "Analog Input" from the menu.
The R&S NGP800 displays the selected "Analog Input" dialog.

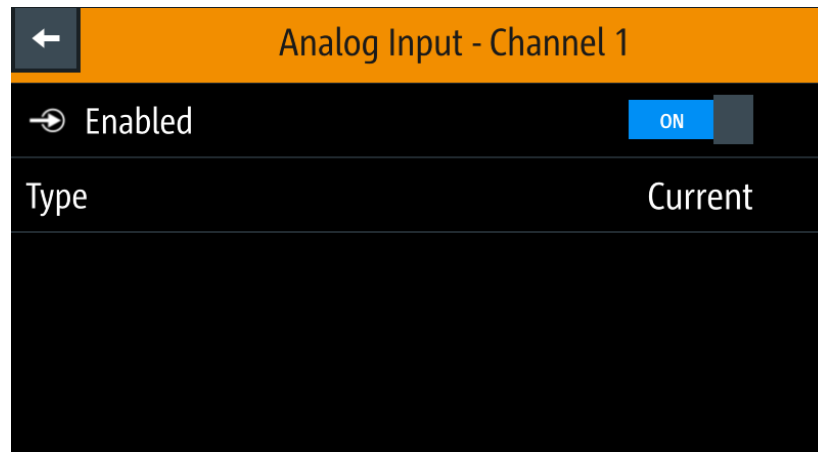

4. Select the required type to regulate the channel output setting.
The R&S NGP800 displays the "Select Analog Input Type" dialog.

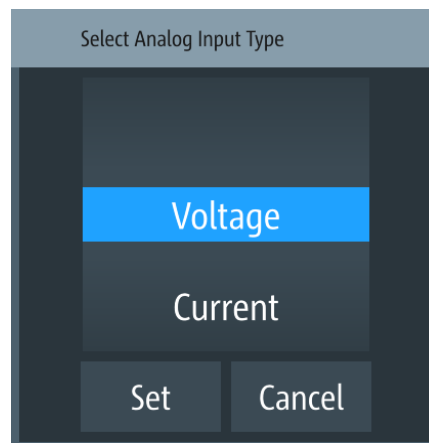

5. Activate the "Enabled" menu item.
The R&S NGP800 enables the "Analog in" input and disables the selected channel settings (voltage or current).

6.4 Protection

There are various ways in which the R&S NGP800 protects itself and the connected load from damage due to overvoltage, overcurrent and overpower drawn by the load during testing.

1. Press [Settings] key.
The R&S NGP800 displays the device/channel menu window.
2. Select the required channel tab to configure the various protection dialogs.
The R&S NGP800 displays the selected channel menu.

6.4.1 Over Current Protection (OCP)



When the drawn current exceeds the limit set for the respective channels, an alert is triggered and the affected channels are turned off according to the settings configured in the OCP dialog.

1. Select "Over Current Protection (OCP)" from the menu.
The R&S NGP800 displays the OCP dialog.

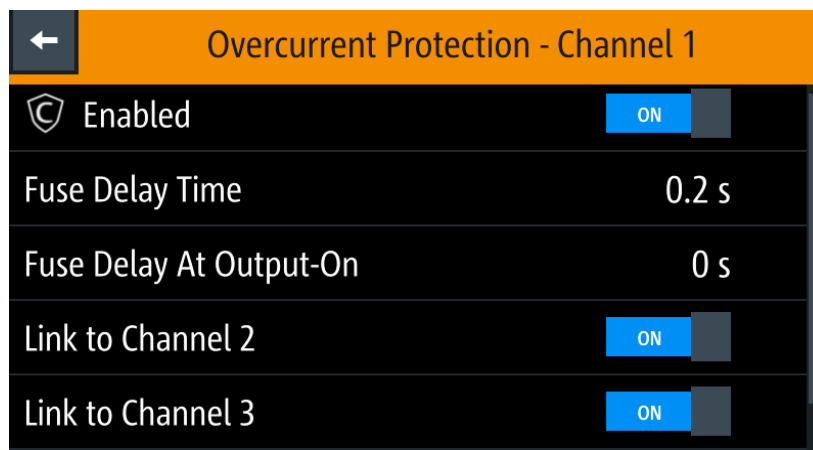

Figure 6-5: Overcurrent protection dialog

2. Activate the "Enabled" menu item.
The R&S NGP800 enables the OCP and displays the OCP icon on the selected channel status bar information.
3. Set the required "Fuse Delay Time" and "Fuse Delay At Output-On".
The R&S NGP800 displays the on-screen keypad to set the values.
 - "Fuse Delay Time": The time taken to turn off the affected channel after OCP is triggered.
 - "Fuse Delay At Output-On": The time taken after channel output is turned on before OCP is put into operation.
4. Confirm value with the unit key (ms or s).
5. Activate the required linked channels for over current protection.
 - ON: The linked channels are turned off when an OCP event is triggered.
 - OFF: The linked channels are not affected when an OCP event is triggered.

6.4.2 Over Voltage Protection (OVP)



When the output voltage exceeds the limit set for the respective channel, an alert is triggered and the affected channel is turned off according to the settings configured in the OVP dialog.

1. Select "Over Voltage Protection (OVP)" from the menu.

The R&S NGP800 displays the OVP dialog.

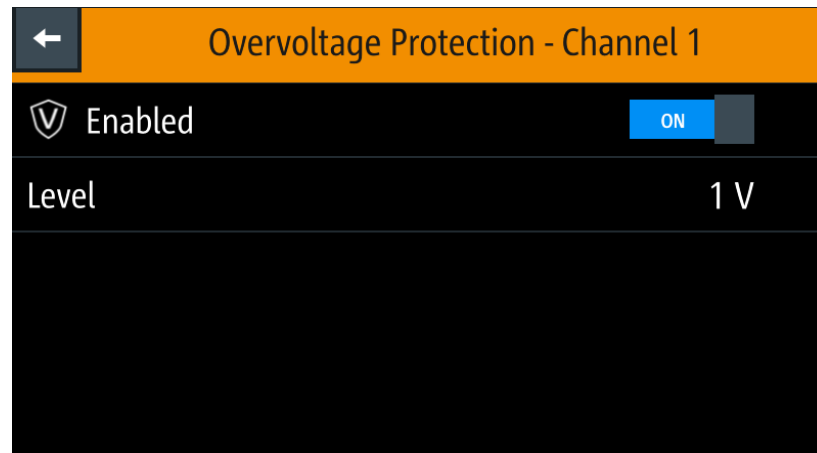

Figure 6-6: Overvoltage protection dialog

2. Activate the "Enabled" menu item.
The R&S NGP800 enables the OVP and displays the OVP icon on the selected channel status bar information.
3. Set the required level for OVP.
The R&S NGP800 displays the on-screen keypad to set the value.
4. Confirm value with the unit key (mV or V).

6.4.3 Over Power Protection (OPP)



When the output power exceeds the limit set for the respective channels, an alert is triggered and the affected channels are turned off according to the settings configured in the OPP dialog.

1. Select "Over Power Protection (OPP)" menu item.
The R&S NGP800 displays the OPP dialog.

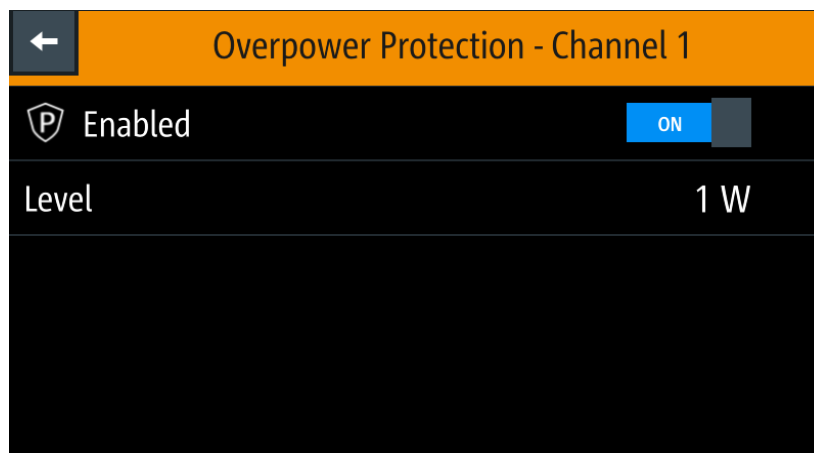
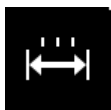

Figure 6-7: Overpower protection dialog

2. Activate the "Enabled" menu item.
The R&S NGP800 enables the OPP and displays the "Over Power Protection (OPP)" icon on the selected channel status bar information.
3. Set the required level for OPP.
The R&S NGP800 displays the on-screen keypad to set the value.
4. Confirm value with the unit key (mW or W).

6.4.4 Safety Limits



With safety limits set in the instrument, the range of the output voltage and/or output current can be limited. The safety limit prevents inadvertently setting values dangerous for the connected DUT.

1. Select "Safety Limits" menu item from the menu.
The R&S NGP800 displays the "Safety Limits" dialog.

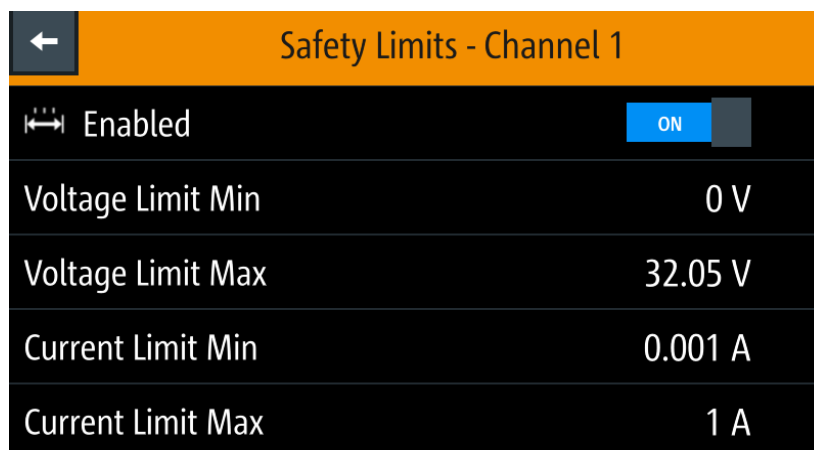

Figure 6-8: Safety limits dialog

2. Activate the "Enabled" menu item.
The R&S NGP800 limits the set voltage and current level and displays the "Safety Limits" icon on the selected channel status bar information.
3. Set the required minimum and maximum value for voltage and current level.
The R&S NGP800 displays an on-screen keypad to set the value.
4. Confirm value with the unit key.

6.5 Tracking Function

For power supplies with multiple channels, the channels can be linked such that changes made on one channel are applied to the tracked channel.

Example:

For example, the Ch 1 output supplies 6 V, intended for digital logic. The other two channels (Ch 2 & Ch 3) supply 20 V, which can be used with bipolar analog circuitry. The tracking adjustments are applied to the two 20 V supplies so that the + and - 20 V supplies can be adjusted together.

1. Press [Settings] key.
The R&S NGP800 displays the device/channel menu window.
2. Select the device tab to configure tracking.
The R&S NGP800 displays the "Tracking" dialog.

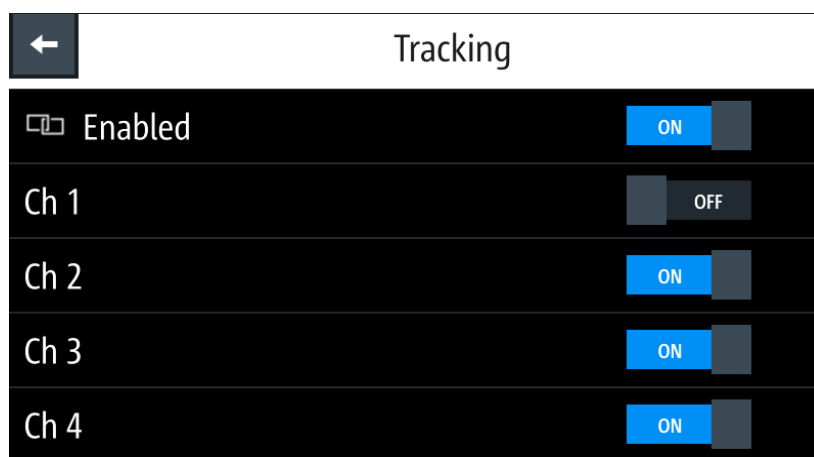

3. Activate the "Enabled" menu item to enable the tracking function.
4. Set the required channels to be tracked.
The R&S NGP800 tracks the voltage and/or current values to the selected tracked channels.

6.6 Digital Trigger I/O

CAUTION

Digital trigger I/O pins voltage rating

Do not exceed the maximum voltage rating of the digital I/O pins when supplying voltages to the pins.

For more information, see the instrument datasheet (P/N: 3609.1927.32).



Instrument option

R&S NGP-K103 (P/N: 5601.6300.03) option is required for the Digital I/O signals.



The eight data lines of the digital I/O interface are mutually independent and can be used as trigger input or trigger output separately. See [Figure 4-4](#) and also [Figure 6-9](#).

- **Trigger input**
The data lines of the digital I/O interface receive external trigger signal. The external trigger signal triggers the selected channel ("Ch 1", "Ch 2", "Ch 3", "Ch 4" or "All") with the set response when the trigger condition ("Active High" or "Active Low") is met.
- **Trigger output**
The data lines of the digital I/O interface output an "Active High" or "Active Low" signal when the trigger condition of the selected channel ("Ch 1", "Ch 2", "Ch 3", "Ch 4") is met.

Table 6-1: Trigger in parameters and conditions

Trigger in parameters	Trigger conditions	Description
Channel	"Ch 1", "Ch 2", "Ch 3", "Ch 4" or "All"	Target output channel selected for trigger response.
Mode	"Enable"	Selected channel output is turned on when the selected logic level is met.
	"Arb"	Selected channel QuickArb function is enabled when the selected logic level is met.
	"Ramp"	Selected channel EasyRamp function is enabled when the selected logic level is met.
	"Logging"	Selected channel logging function is enabled when the selected logic level is met.
	"Statistics"	Selected channel statistics function is enabled when the selected logic level is met.
	"AnalogIn"	Selected channel analog input is enabled when the selected logic level is met.

Trigger in parameters	Trigger conditions	Description
	"Inhibit"	<p>Selected channel output is inhibited when the selected logic level is met.</p> <p>If the selected channel output is put to inhibit state, manual or remote operation on selected channel output is no longer possible .</p> <p>To reverse the inhibit state, remove the source of the trigger signal. You can either disable the affected DIO interface or remove the source from the affected DIO interface at the rear panel.</p>
Active Level	High	Set the logic level of the trigger in signal.
	Low	

Table 6-2: Trigger out parameters and conditions

Trigger out parameters	Trigger conditions	Description	
Channel	"Ch 1", "Ch 2", "Ch 3", "Ch 4"	Output channel selected to monitor for trigger conditions.	
Mode	Output	Output the selected logic level when the output is turned on at the selected channel.	
	Fuse	<p>Output the selected logic level when a fuse tripped event occurs on the selected channel.</p> <p>See Chapter 6.4.1, "Over Current Protection (OCP)", on page 50 .</p>	
	Operation mode	<ul style="list-style-type: none"> "CC": Output the selected logic level when the selected channel operates in the CC mode. See "CC mode" on page 42. "CV": Output the selected logic level when the selected channel operates in the CV mode. See "CC mode" on page 42. 	
	Voltage Level, "Vset"	>= "set value"	Output the selected logic level when the voltage level of the selected channel is greater or equal to the set voltage level.
	Current Level, "Iset"	>= "set value"	Output the selected logic level when the current level of the selected channel is greater or equal to the set current level.
	Power Level, "Plevel"	>= "set value"	Output the selected logic level when the power level of the selected channel is greater or equal to the set power level.
	Critical event	"OVP" "OPP" "OTP"	Output the selected logic level when the selected critical event ("OVP", "OPP", "OTP") occurs on the selected channel. See Chapter 6.4, "Protection" , on page 49.

Trigger out parameters	Trigger conditions	Description
	"Logging"	Output the selected logic level when the logging is enabled.
Active Level	High	Set the logic level of the trigger out signal.
	Low	

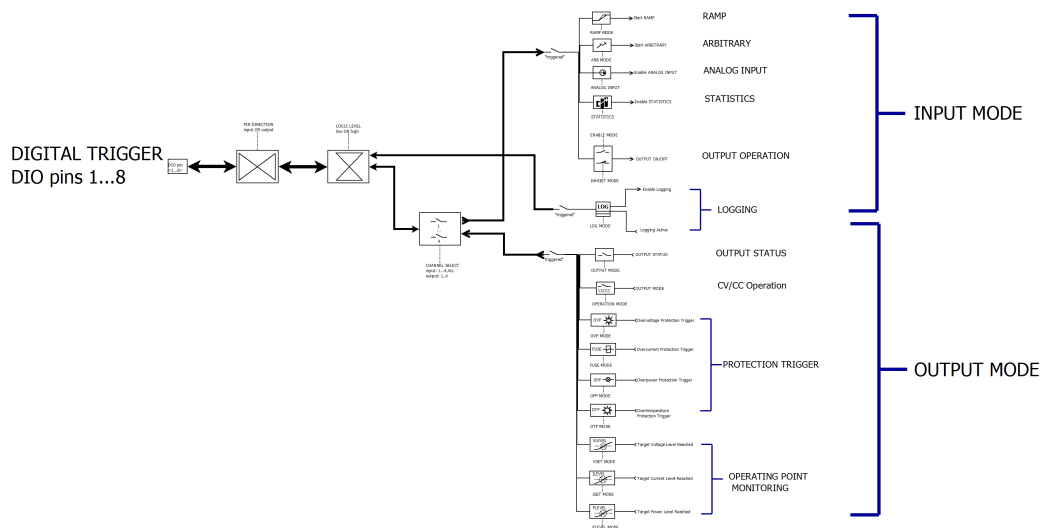

Figure 6-9: DIO trigger block diagram

1. Press [Settings] key.
The R&S NGP800 displays the device/channel menu window.
2. Select the device tab to configure digital I/O trigger.
The R&S NGP800 displays the "Digital Trigger Menu" dialog.

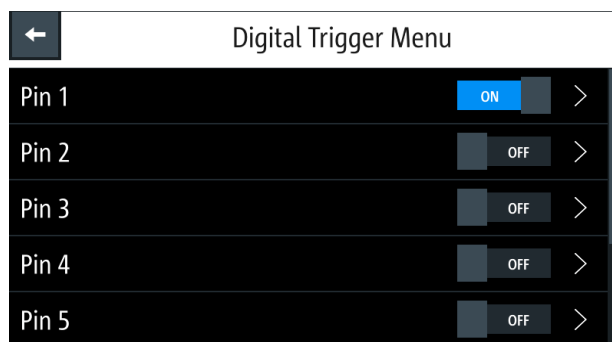

Figure 6-10: Digital trigger menu

3. Set the required pins to "ON" to enable the respective trigger settings for the selected pins.
4. Select the respective pins to configure the trigger settings.
The R&S NGP800 displays the respective pin dialog for configuration.

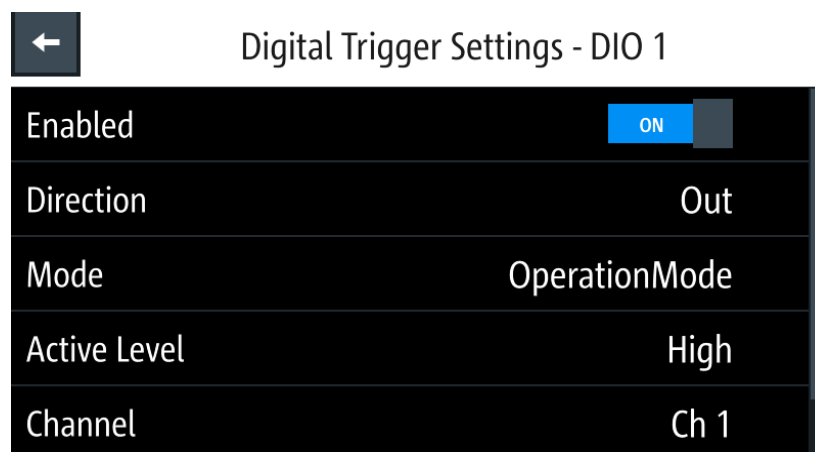

Figure 6-11: Digital trigger settings for pin 1

- Set the required pin "Direction".
Depending on the pin direction, different operating modes are available for trigger settings.
See [Table 6-1](#) and [Table 6-2](#).
- Set the required "Active Level " and "Channel" settings.
- Press the [Settings] key to return to device menu dialog.
- Set the "Digital I/O Trigger" to "ON" to enable the digital I/O trigger.
The R&S NGP800 monitors the digital I/O trigger conditions and feedback to the respective channels or pins.

6.7 Advanced Features



Channel settings

If QuickArb function of a selected channel is enabled, the respective channel voltage and current setting is disabled.

See [Chapter 6.1, "Setting the Channels Voltage and Current"](#), on page 43.

The QuickArb and EasyRamp are two functions which can be used to control the waveform of voltage and current output.

6.7.1 QuickArb



The QuickArb function allows you to generate freely programmable waveforms which can be reproduced within the [Safety Limits](#) for voltage and current.

- Press [Settings] key.

The R&S NGP800 displays the device/channel menu window.

2. Select the required channel tab to configure QuickArb function.
The R&S NGP800 displays the selected channel menu.
3. Select "Arbitrary" from the menu.
The R&S NGP800 displays the "Arbitrary" dialog.

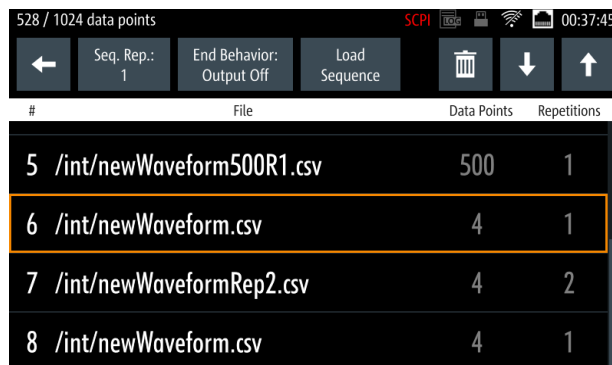

#	File	Data Points	Repetitions
5	/int/newWaveform500R1.csv	500	1
6	/int/newWaveform.csv	4	1
7	/int/newWaveformRep2.csv	4	2
8	/int/newWaveform.csv	4	1

4. Select any of the rows to load or change the arbitrary file in the arbitrary sequence.
Up to eight arbitrary files with a maximum of 1024 data points can be loaded.
The R&S NGP800 opens a dialog to select the source and file location.
5. Select the required source and file location.
6. Select "Select" to load the selected file.
The R&S NGP800 loads the selected arbitrary file.

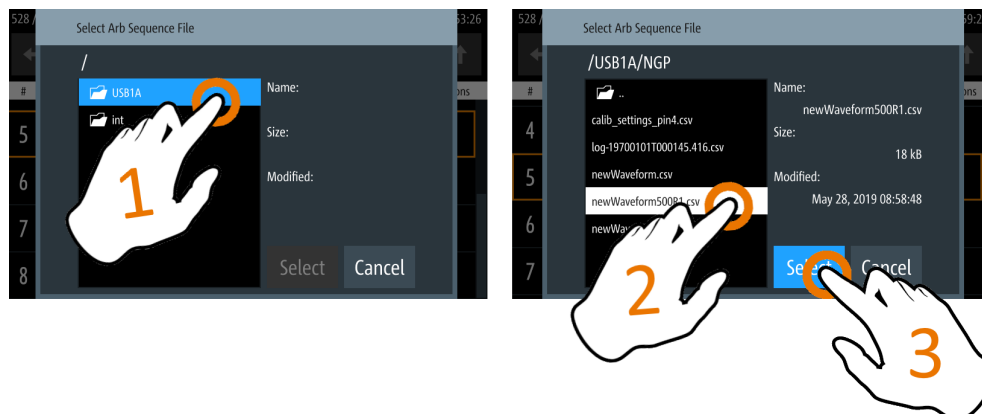

7. Select delete and up/down button  to navigate the arbitrary test sequence.
8. Select "Load Sequence" to load the arbitrary test sequence.
9. Set "Seq. Rep." and "End Behavior" to configure the arbitrary sequence behavior.
 - "Seq. Rep.": Repetition cycle for the arbitrary sequence
 - "End Behavior": End behavior of the automation of arbitrary function
 - "Off": Output of the selected channel is turned off after performing the arbitrary function.
 - "Hold": Last voltage and current values output at the instrument.

10. Select [Back] key to return to channel menu dialog.
11. Activate the "Arbitrary" menu item to enable the QuickArb function.
The R&S NGP800 enables the QuickArb function and displays the "Arbitrary" icon on the selected channel status bar information.

Arbitrary editor



The "Arb Editor" dialog allows you to edit the arbitrary profile ("Voltage", "Current", "Time", "Interpolate" status, "Rep." and "End Behavior"). To view or open the list of available arbitrary files, select  to open the arbitrary file.



#	Voltage	Current	Time	Interpolate
1	1.000 V	1.000 0 A	0.001 s	<input checked="" type="checkbox"/>
2	1.588 V	1.000 0 A	0.001 s	<input checked="" type="checkbox"/>
3	1.951 V	1.000 0 A	0.001 s	<input checked="" type="checkbox"/>
4	1.951 V	1.000 0 A	0.001 s	<input checked="" type="checkbox"/>

Figure 6-12: Arbitrary editor dialog

1. Configure the "Arb Editor" with the required voltage, current and duration.
The R&S NGP800 displays the on-screen keypad for data entry.
2. Confirm values with the unit keys.
3. Select the interpolation checkbox to toggle on/off the interpolation function on the arbitrary data.
4. Select the "Plus" or "Minus" icon to add or delete the arbitrary data from the dialog.
 - "+": A new row of arbitrary data is added to the end of the table. The new addition is a copy of the last arbitrary data in the table.
 - "-": To delete, select the row of arbitrary data for deletion follows by the "Minus" icon.
5. Set the "Rep" to configure repetition cycle for the arbitrary data.
By default, the repetition cycle is set to infinity.
6. Set the "End Behavior" to handle the way to end the automation of the arbitrary function.
 - "Off": The output of the selected channel is turned off after performing the arbitrary function.

- "Hold": The last voltage and current values remains at the output terminal of the instrument.
7. Select  (new file) or  (existing file) to save the arbitrary data. The R&S NGP800 displays a popup message to show that file saved successfully.

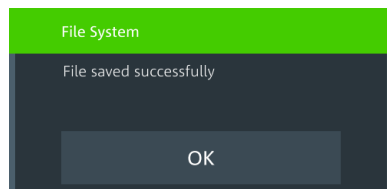

6.7.2 EasyRamp

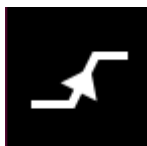

The EasyRamp function configures a constant rise of supply voltage within a set time frame. The output voltage can be increased continuously within a 10 ms to 10 s with 1 ms step size. Each channel has an independent ramp configuration. See [Figure 6-13](#).

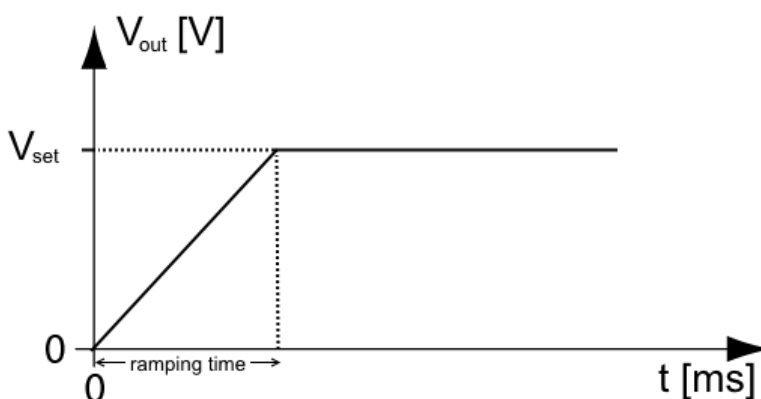

Figure 6-13: Ramping voltage output

1. Press [Settings] key.
The R&S NGP800 displays the device/channel menu window.
2. Select the required channel tab to configure EasyRamp function.
The R&S NGP800 displays the selected channel menu.
3. Select "Ramp" from the menu.
The R&S NGP800 displays the "Ramp" dialog.

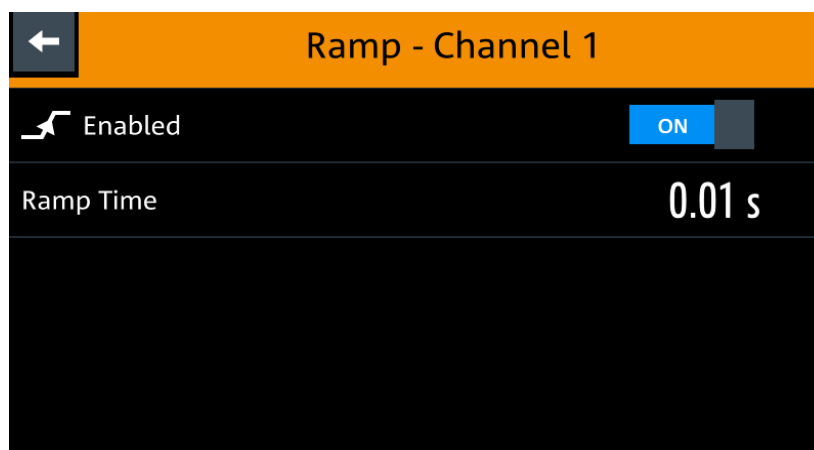

Figure 6-14: Ramp dialog

4. Activate the "Enabled" menu item.
The R&S NGP800 enables the EasyRamp function and displays the "Ramp" icon on the selected channel status bar information.
5. Set the required "Ramp Time".
The R&S NGP800 displays the on-screen keypad to set the value.
6. Confirm value with the unit key.

6.8 User Key



The R&S NGP800 allows you to configure the user action for one of the following functions:

- Screenshot image from instrument
 - Data logging
 - Reset statistic (see index 1, 2, 3 of [Figure 5-6](#))
 - Enable/Disable touchscreen function
1. Press [Settings] key.
The R&S NGP800 displays the device/channel menu window.
 2. Select the "Device" menu tab to configure user action.
The R&S NGP800 displays the device menu.
 3. Select "User Button" from the menu.
Alternatively, long pressed on the [*] key to configure the user button action.
The R&S NGP800 displays the "User Button" dialog.

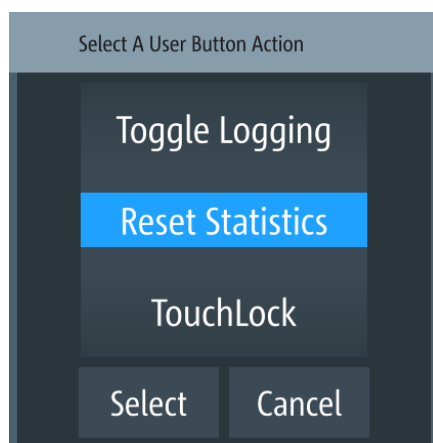

Figure 6-15: User button action

4. Select the "User Button Action" to configure the user action.
The R&S NGP800 displays a dialog to configure the user action.
5. Select the required user action.
 - "Screenshot": Capture the current screen image of the instrument
 - "Toggle Logging": Enable/Disable the data logger function
 - "Reset Statistics": Reset sample count, energy result, power, voltage and current values
 - "TouchLock": Enable/Disable the touchscreen function of the instrument
6. Select "Select" to confirm the action.

6.9 Screenshot



With screenshot, you can capture image easily from the instrument. The images can be stored in the USB stick or internal memory of the instrument. By default, the screen images are stored in the USB device under the target folder.

1. Press [Settings] key.
The R&S NGP800 displays the device/channel menu window.
2. Select the "Device" tab to configure screenshot file location.
The R&S NGP800 displays the device menu.
3. Select "Screenshot" from the menu.
The R&S NGP800 displays the "Screenshot" dialog.

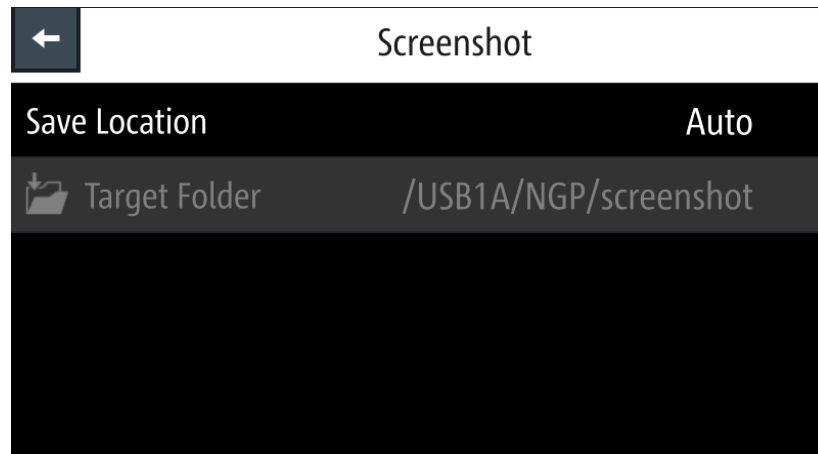

Figure 6-16: Screenshot dialog

4. Select the "Save Location" to configure the screenshot file location.
 - "Auto": Target folder is set to default file location:
 - With USB stick detected:
 - /USB1A/NGP/screenshot for NGP models
 - Without USB stick detected:
 - /int/screenshot
 - "Manual": Choice of target folder.
5. Select the required save location.

6.10 Data Logging



When data logging is activated, the R&S NGP800 records the voltage, current and power data and stores it in the predefined target folder. The measurement data can be stored on the USB stick or in the instrument internal memory location.

1. Press [Settings] key.
The R&S NGP800 displays the device/channel menu window.
2. Select the "Device" tab to configure data logger.
The R&S NGP800 displays the device menu.
3. Select "Logging" menu item from the menu.
The R&S NGP800 displays the "Logging" dialog.

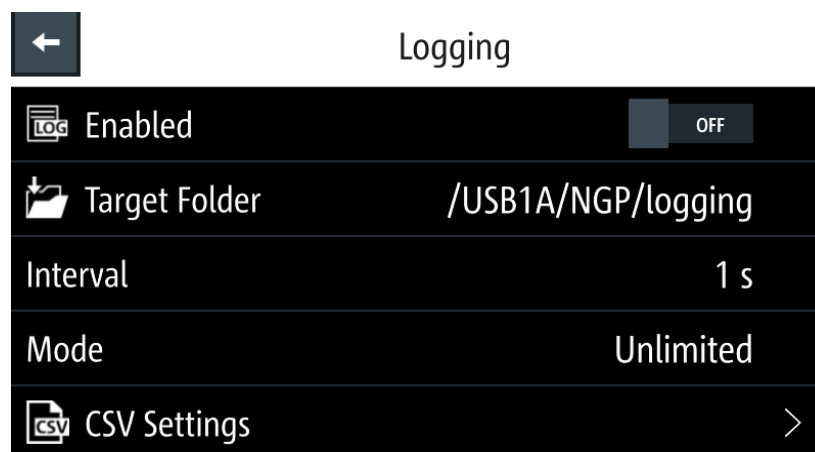

4. Select the "Target Folder" menu item to select the predefined target folder for data logger.
If no USB stick is detected, "Target Folder" is set to internal memory ("int") partition. By default, "USB1A" partition is selected if USB stick is detected.

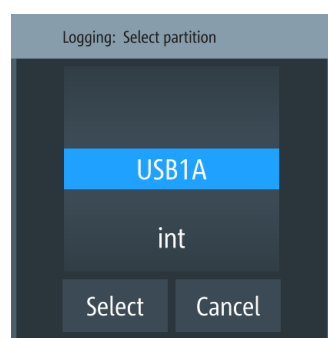

Figure 6-17: Target folder dialog

5. Set the required "Target Folder".
6. Select "Mode" to set logging duration.
 - "Duration": Time taken for data logging with duration and time interval setting.
 - "Span": Time taken for data logging with start time, time interval and duration setting
 - "Unlimited": Data logging with time interval setting. The data logging continuous until function is deactivated.
 - "Count": Data logging with number of counts and time interval setting
7. Depending on the selected mode, configure the required settings for the data logging duration.
8. Activate the "Enabled" menu item.
The R&S NGP800 activates the logging and disables the settings for file saved location and logging mode settings.
9. Configure the "CSV Settings".

See [Chapter 6.11, "CSV Settings"](#), on page 65.

6.11 CSV Settings



A CSV file stores tabular data (numbers and text) in plain text. Each line of the file is a data record and each record consists of one or more fields, separated by a file delimiter. The "CSV Settings" provides you ways to format the fields that are stored in the data logging. See [Figure 6-18](#).

#Device	NGP802						
#Calibration Ch1	factory						
#Calibration Ch2	factory						
Timestamp	U1[V]	I1[A]	P1[W]	U2[V]	I2[A]	P2[W]	
12:51.3	5.1801	0.00161	0.00835	11.0004	0.00059	0.00652
12:51.4	5.1801	0.0016	0.00831	11.0003	0.0006	0.00665
12:51.5	5.1801	0.00161	0.00836	11.0004	0.0006	0.00657
12:51.6	5.1801	0.0016	0.0083	11.0004	0.0006	0.00658
12:51.7	5.1801	0.00161	0.00832	11.0004	0.00062	0.00679
12:51.8	5.1801	0.00162	0.00838	11.0003	0.00062	0.00682
12:51.9	5.1801	0.00161	0.00836	11.0003	0.0006	0.00660
12:52.0	5.1801	0.00161	0.00835	11.0004	0.0006	0.00662
12:52.1	5.1801	0.00161	0.00834	11.0004	0.0006	0.00663
12:52.2	5.1801	0.00162	0.00837	11.0004	0.00062	0.00683
12:52.3	5.1801	0.00162	0.00838	11.0004	0.00062	0.00686
12:52.4	5.1801	0.00161	0.00836	11.0004	0.00063	0.00695
12:52.5	5.1801	0.00161	0.00836	11.0004	0.00062	0.00681
12:52.6	5.1801	0.00161	0.00834	11.0004	0.00062	0.00683
12:52.7	5.1801	0.00161	0.00833	11.0004	0.00062	0.00684
12:52.8	5.1801	0.0016	0.00829	11.0003	0.00062	0.00682
12:52.9	5.1801	0.00159	0.00825	11.0004	0.00062	0.00683
12:53.0	nan	nan	nan	nan	nan	nan	
12:53.1	nan	nan	nan	nan	nan	nan	
12:53.2	nan	nan	nan	nan	nan	nan	

Figure 6-18: Sample of data logging

1. Select "CSV Settings" from "Device" menu or "Logging" menu. The R&S NGP800 displays the "CSV Settings" dialog.

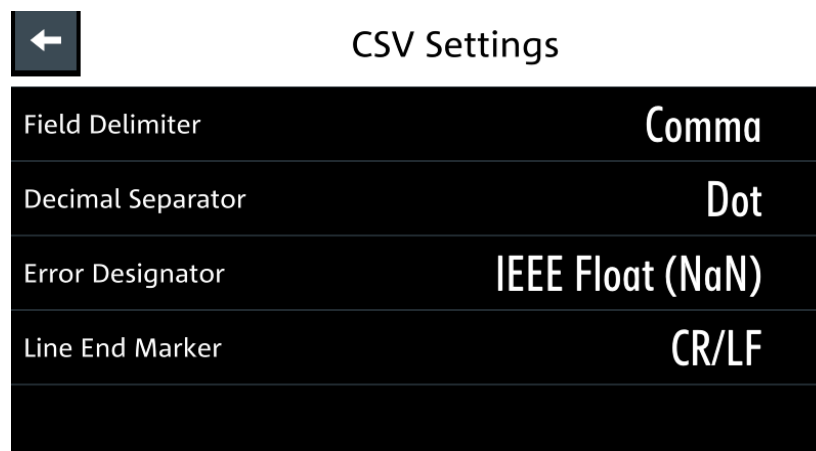

Figure 6-19: CSV settings dialog

- Set the required CSV parameters.
The R&S NGP800 displays the respective dialog to set the CSV parameters.
See [Table 6-3](#).
- Select "Set" to confirm the value.

Table 6-3: CSV settings

CSV Settings	Selective fields in the dialog
Field Delimiter	"Comma", "Semicolon"
Decimal Separator	"Dot", "Comma"
Error Designator	"IEE Float (NaN)", "Empty"
Line End Marker	"CR/LF", "LF"

6.12 File Manager



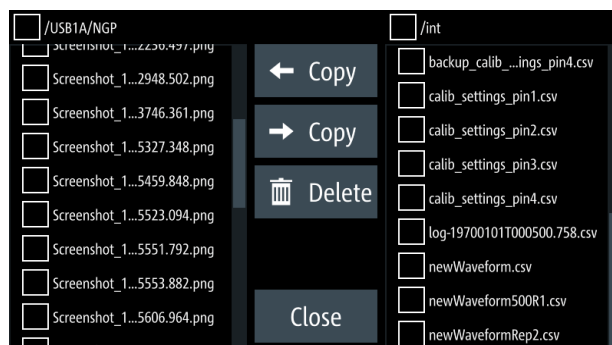

The "File Manager" provides file transfer functions between USB stick and internal memory of the instrument. You can copy and delete files in both USB stick and internal memory of the instrument.

- Press [Settings] key.
The R&S NGP800 displays the device/channel menu window.
- Select the "Device" tab to configure file settings for store and recall function.
The R&S NGP800 displays the device menu.
- Select "File Manager" from the menu.
The R&S NGP800 displays the file manager dialog.

**Figure 6-20: File manager dialog**

- Select the file that you want to copy or delete.
- Select the required action in the file manager dialog.
See [Table 6-4](#).

Table 6-4: File manager action

Action	Description
	Copy from internal memory to USB.
	Copy from USB to internal memory.
	Delete the selected file.

6.13 Store and Recall



Upon power-up, the instrument loads the last stored settings from internal memory location. Auto saved parameters are also applied during startup.

The R&S NGP800 output states of all channels (Ch 1, Ch 2, Ch 3, Ch 4) are disabled when the recall function is activated.



Auto saved instrument settings

Auto saved of the instrument settings is applied when any of the following parameters are changed:

- [Chapter 6.15, "General Instrument Settings"](#), on page 76
- USB connection mode
- Ethernet settings

In addition of the auto saved instrument settings, the following instrument settings are stored or recalled in the internal memory:

- [Set voltage and current level](#)
- [Settings in the Protection Function, Safety Limits](#)
- [Data Logging settings](#)

1. Press [Settings] key.
The R&S NGP800 displays the device/channel menu window.
2. Select the "Device" tab to configure file settings for store and recall function.
The R&S NGP800 displays the device menu.
3. Select "Save/Recall Device Settings".
The R&S NGP800 loads the "Save/Recall Device Settings" dialog.

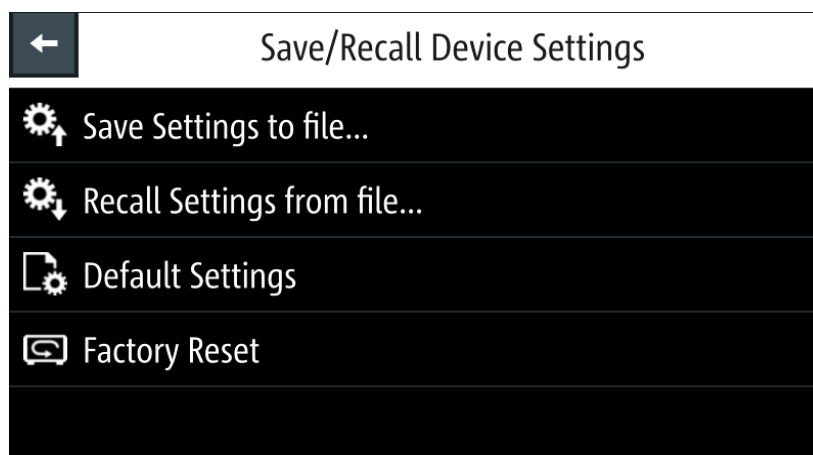
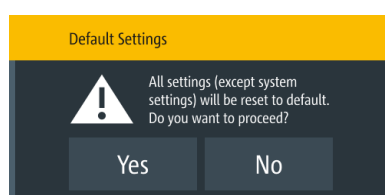

Figure 6-21: Save/Recall device settings dialog

4. Select "Save Settings to file" to save current instrument settings. The R&S NGP800 opens a dialog to select source and file location. You can save to existing file or create a file for saving.
5. Set the source and file location. The R&S NGP800 saves the current instrument settings.
6. Similar, you can select "Recall Settings from file" to load instrument settings. The R&S NGP800 opens a dialog to select source and file location.
7. Set the source and file location. The R&S NGP800 resets the instrument with the loaded instrument settings.

To reset the instrument settings to factory default:

1. Select "Default Settings" from the "Save/Recall Device Settings" dialog. The R&S NGP800 displays a popup message.



2. Select "Yes" to overwrite instrument settings to default. The R&S NGP800 resets current instrument settings to default.
3. The R&S NGP800 displays a popup message to show that all settings are reset to default.

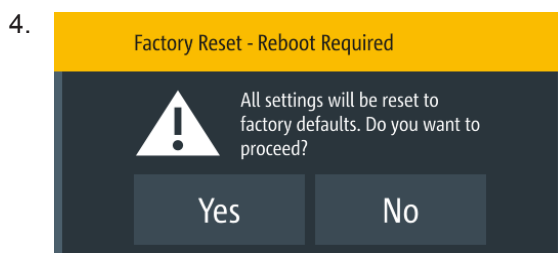
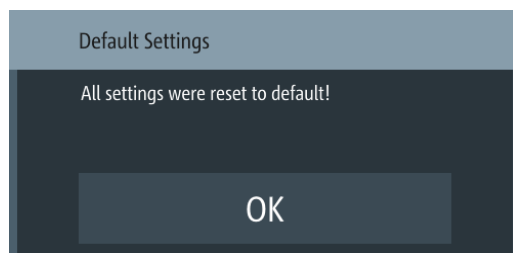

Select "Factory Reset" to proceed to reset instrument settings to factory default with a reboot.

5. Select "Yes" to proceed factory reset.

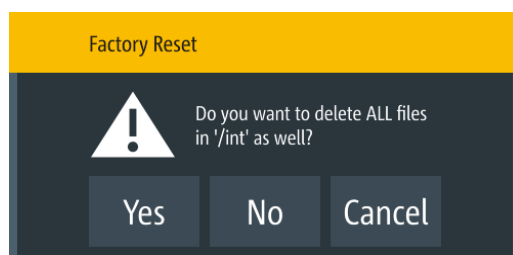

6. Select "No" to keep all files in the `/int` directory.
Select "Yes" to remove all files (arb, logging, screenshots, settings) except the files in the documentation folder under the `/int` directory.

6.14 Interfaces

There are various of ways how the R&S NGP800 can be remotely accessed and controlled.

1. Press [Settings] key.
The R&S NGP800 displays the device/channel menu window.
2. Select the "Device" tab to configure network connection.
The R&S NGP800 displays the device menu.
3. Select "Interfaces".
The R&S NGP800 displays the "Interfaces" dialog.

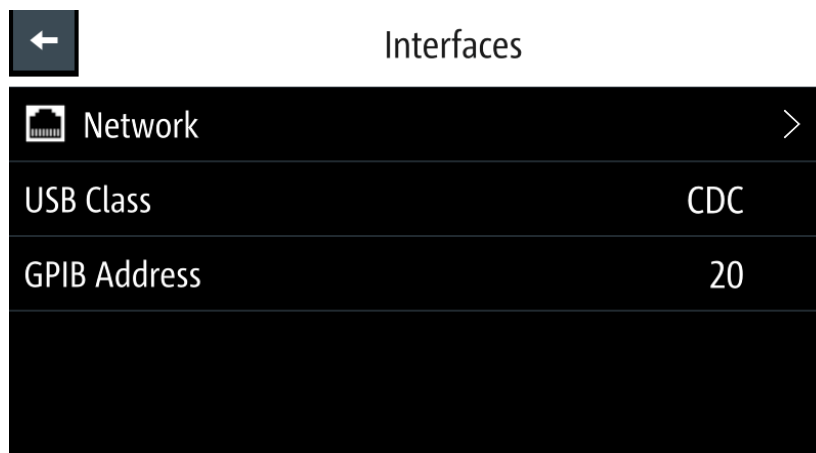

Figure 6-22: Interfaces dialog

4. Select the connected interface ([Network](#), [USB Class](#) or [GPIB Address](#)) to configure the necessary parameters required.

- [Network Connection](#).....70
- [USB Connection](#).....74
- [GPIB Address](#)..... 75

6.14.1 Network Connection



There are two methods to establish a local area network (LAN) connection with the R&S NGP800 for remote control operation.

- [LAN](#)
- [Wireless LAN](#)

1. Select "Network" from the [Figure 6-22](#).
The R&S NGP800 displays the "Network" dialog.

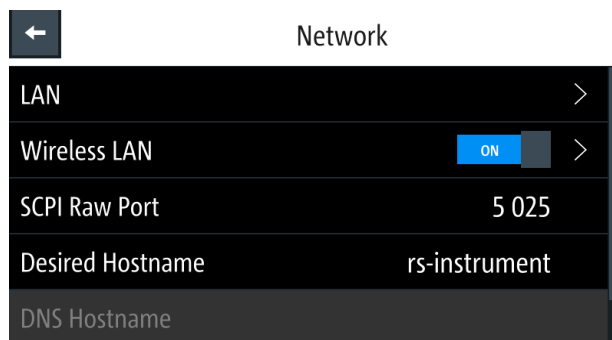

Figure 6-23: Network dialog

2. Set the required "SCPI Raw Port" and "Hostname".
The R&S NGP800 displays the on-screen keypad to enter the port number and hostname.

- "SCPI Raw Port": A port number used to open a raw TCP/IP connection to send raw SCPI commands to the instrument
- "Desired Hostname": The name assigned to the instrument used to identify it in the network
- "DNS Hostname","mDNS Hostname" : The name assigned to the domain name used to identify it in the network

When the connection is available, the network icon is highlighted in white on the device status bar information.

6.14.1.1 LAN Connection

The R&S NGP800 is equipped with a network interface and can be connected to an Ethernet LAN (local area network). A LAN connection is necessary for remote control of the instrument, and for access from a computer using a web browser.

NOTICE

Risk of network failure

Before connecting the instrument to the network or configuring the network, consult your network administrator. Errors may affect the entire network.



To establish a network connection, connect a commercial RJ-45 cable to the LAN port of the instrument and to a PC or network switch.

Depending on the network capacities, the TCP/IP address information for the instrument can be obtained in different ways.

- If the network supports dynamic TCP/IP configuration using the Dynamic Host Configuration Protocol (DHCP), and a DHCP server is available, all address information can be assigned automatically.
- Otherwise, the address must be set manually. Automatic Private IP Addressing (APIPA) is not supported.

By default, the instrument is configured to use dynamic TCP/IP configuration and obtain all address information automatically. This means that it is safe to establish a physical connection to the LAN without any previous instrument configuration.

NOTICE

Risk of network errors

Connection errors can affect the entire network. If your network does not support DHCP, or if you choose to disable dynamic TCP/IP configuration, you must assign valid address information before connecting the instrument to the LAN. Contact your network administrator to obtain a valid IP address.

1. Connect the LAN cable to the LAN connector at the rear panel of the instrument.
2. Select "LAN" to set LAN connection.
The R&S NGP800 displays the "LAN" dialog.
Note: The "MAC Address" is fixed.

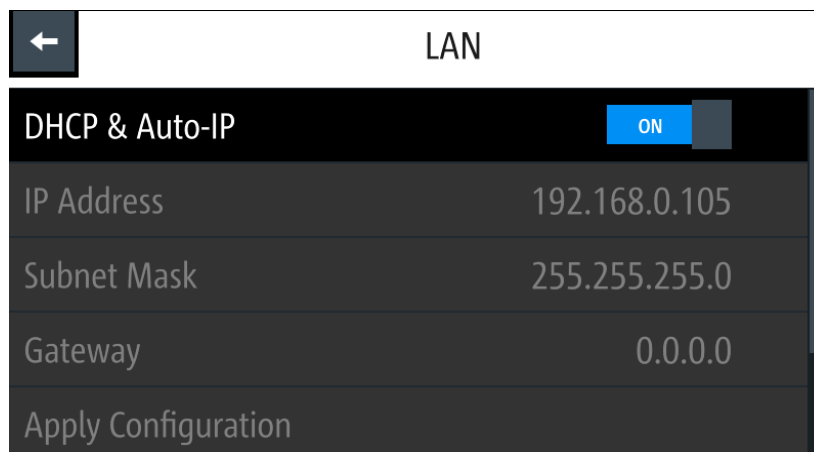

Figure 6-24: Ethernet settings dialog

3. Set the "DHCP & Auto-IP".
 - "ON": Enables DHCP for automatic network parameter distribution and shows the values of the IP Address. By default, the instrument is configured to use dynamic configuration and obtain all address information automatically.
 - "OFF": If the network does not support dynamic host configuration protocol (DHCP). The addresses must be set manually.
4. Set the required DHCP mode.
If DHCP mode is set "OFF", the following "Ethernet Settings" are required.
5. Configure the "IP Address", "Subnet Mask" and "Gateway".
The R&S NGP800 displays the IP dialog for configuration.

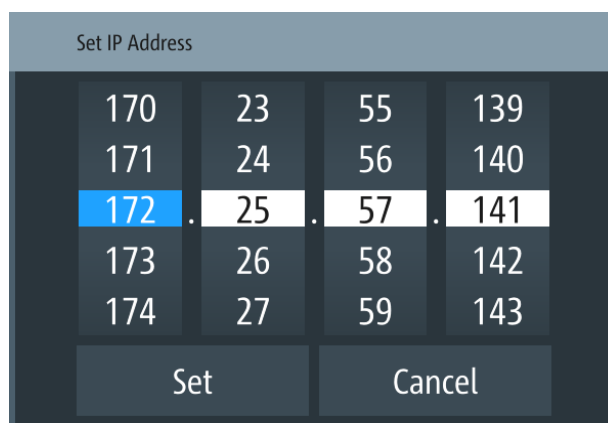

Figure 6-25: IP dialog

6. Set the required IP addresses for "IP Address", "Subnet Mask" and "Gateway"

7. Select "Set" to confirm the value.
8. Select "Apply Configuration" to apply the changes.

6.14.1.2 Wireless LAN Connection

WARNING

Risk of RF exposure

When WLAN is active, a minimum separation distance of 20 cm from front panel of the instrument must be observed at all times.

When WLAN is active, no operation of antenna or transmitter should be co-located with the instrument.



Wi-Fi transmitter performance

Frequency range: 2412 MHz to 2472 MHz

Power: 19.5 dBm typical



Instrument option

R&S NGP-K102 (P/N: 5601.6400.03) option is required to connect the R&S NGP800 to a network via wireless LAN connection.

An alternative to connection in local area network is wireless LAN connection. With the presence of an authenticated Wi-Fi signal, the R&S NGP800 automatically connects to a network and navigation can be made via the web browser according to the WLAN IEEE 802.11 b/g/n standards.

1. Select "Wireless LAN" to set LAN connection.
The R&S NGP800 displays the "Wireless LAN Settings" dialog.

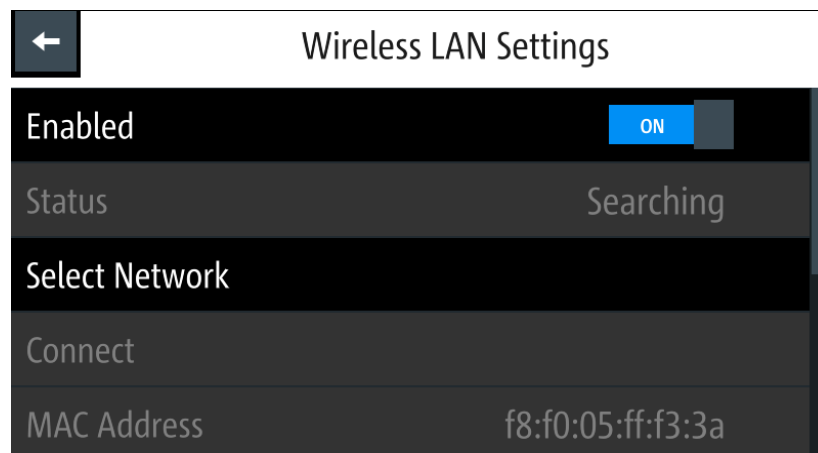

Figure 6-26: WLAN settings dialog

2. Select "Enable" menu item to set "On" to enable wireless LAN.
The R&S NGP800 began searching available WiFi network and the "Status" shows "Searching".
3. Select the "Select Network" to connect the required WiFi network.
If connection is successful, the "Status" shows "Connected". See [Figure 6-27](#).
When the connection is alive, the WLAN icon turns white on the device status bar.
See ["Device status bar"](#) on page 30.

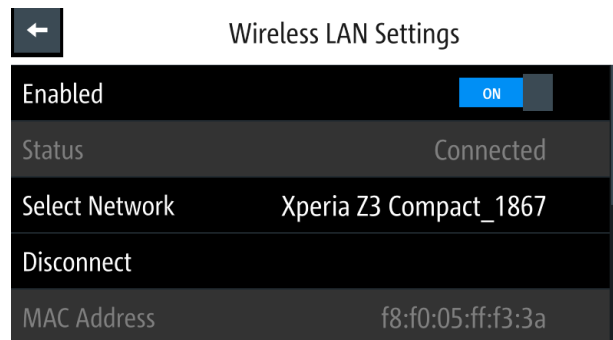

Figure 6-27: WLAN connected

4. To disconnect, select the Disconnect in the "Wireless LAN settings" dialog.

6.14.2 USB Connection

Alternatively, connect a USB cable to the USB port (see [Figure 4-3](#)) and PC for a USB connection. The R&S NGP800 supports USB CDC and USB TMC connection.

1. Select "USB Class" from the "Network Connections" dialog.
The R&S NGP800 displays the USB class dialog to select the USB connection.



Figure 6-28: USB dialog

2. Set the USB class.
3. Select "Set" to confirm the selection.

6.14.3 GPIB Address



Instrument option

R&S NGP-B105 (P/N: 5601.6000.02) option needs to be installed for the remote command of R&S NGP800 via GPIB interface.

The GPIB interface, sometimes called the General Purpose Interface Bus (GPIB), is a general purpose digital interface system that can be used to transfer data between two or more devices. Some of its key features are:

- Up to 15 instruments can be connected
- The total cable length is restricted to a maximum of 15 m; the cable length between two instruments should not exceed 2m
- A wired "OR"-connection is used if several instruments are connected in parallel

To be able to control the instrument via the GPIB bus, the instrument and the controller must be linked by a GPIB bus cable. A GPIB bus card, the card drivers and the program libraries for the programming language must be provided in the controller. The controller must address the instrument with the GPIB instrument address.

GPIB instrument address

To operate the instrument via remote control, it must be addressed using the GPIB address. The default remote control address is factory-set at 20, the addresses of 0 through 30 are allowed.

The GPIB address is maintained after a reset of the instrument settings.

1. Select "GPIB Address" from the [Figure 6-22](#).
The R&S NGP800 displays an on-screen keypad to set the value.



2. Enter the required value.
3. Confirm value with the enter key

6.15 General Instrument Settings

The following chapters provide the general instrument information and utilities services in "Device" menu.

1. Press [Settings] key.
The R&S NGP800 displays the device/channel menu window.
2. Select the "Device" tab.
The R&S NGP800 displays the device menu.

6.15.1 Licenses Management

Options are enabled by entering a registered license key code.

You may choose to install from an XML file on USB or by manually entering the key code.

- ▶ Select "Licenses" to install license key code.
The R&S NGP800 displays the license dialog.
 - "Active": Options that are currently active in the instrument
 - "Inactive": Options that are currently not active in the instrument
 - "Deactivation": Options that are expired or removed in the instrument



Figure 6-29: License dialog

To install an XML file, proceed as follows:

1. Copy the XML file containing the registered key code into the USB flash drive.
2. Connect the USB flash drive to the USB port of the instrument.
3. Select "Load File" to load the license file from the USB stick.
4. Select the license file to install in the instrument.
The R&S NGP800 install the license option accordingly.

If the installation is successful, the option is displayed in the "Active" window.

To manually enter the key code, proceed as follows:

1. Select "Add" key to invoke the license key on-screen keyboard.

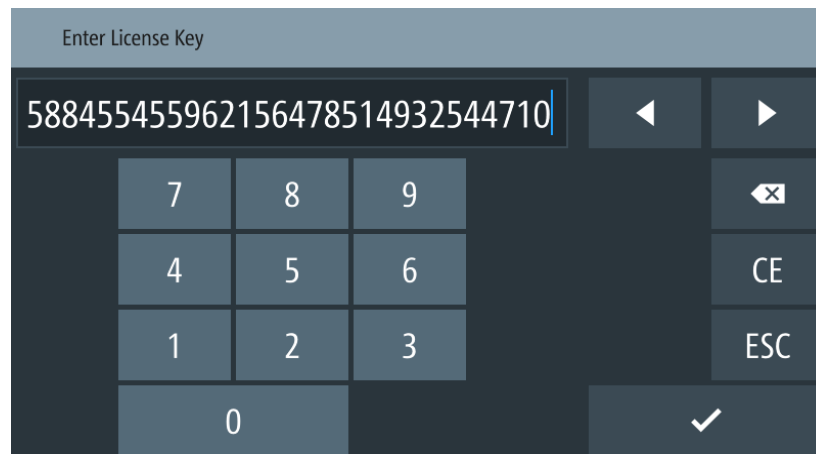

Figure 6-30: License key on-screen keyboard

2. Enter the key code (30-digit number) of the option in the entry box.
3. Confirm entries with the enter key .
If the correct key code is entered, the R&S NGP800 popup a message "Devicekey is installed" and the option is displayed in the "Active" window.
4. To remove the option, select "Remove" from the license dialog.
The R&S NGP800 displays the license key on-screen keyboard. See [Figure 6-30](#).
5. Enter the key code (30-digit number) of the option in the entry box.
6. Confirm entries with the enter key .
If the correct key code is entered, the R&S NGP800 popup a message "Devicekey is removed" and the option is displayed in the "Deactivation" window.

6.15.2 Appearance Settings



- ▶ Select the "Appearance" to set display and key brightness.
The R&S NGP800 displays the appearance dialog.



Figure 6-31: Appearance dialog

6.15.3 Sound Settings



1. Select the "Sound Settings" to set sound settings.
The R&S NGP800 displays the sound settings dialog.

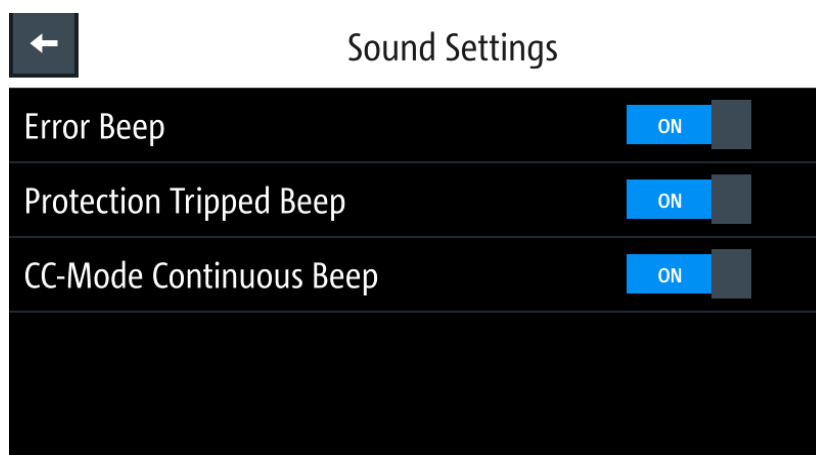

Figure 6-32: Sound settings dialog

2. Select the required fields to set alert.
 - "Error Beep": A single beep alert when error occurs.
 - "Protection Tripped Beep": A single beep alert when a protection tripped (OCP, OVP, OPP) occurs. See [Chapter 6.4, "Protection"](#), on page 49.
 - "CC-Mode Continuous Beep": A continuous beep sound alert when the selected output channel goes into CC mode. See ["CC mode"](#) on page 42.

6.15.4 Date and Time



The time is regarded as UTC. There is no timezone selectable.



1. Select the "Date & Time" to set date and time format.
The R&S NGP800 displays the date and time dialog.

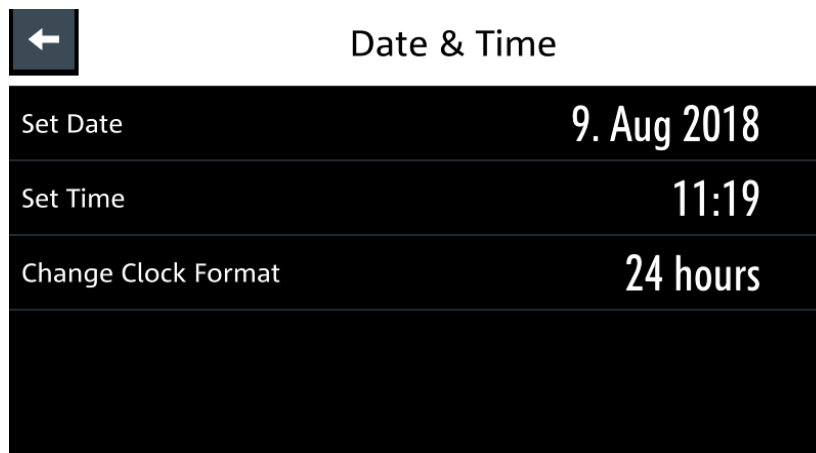

Figure 6-33: Sound settings dialog

2. Select the required field to configure.
The R&S NGP800 reset the instrument date and time accordingly.

6.15.5 Device Information



General instrument information of R&S NGP800.

- ▶ Select the "Instrument Information" to display the device information.
The R&S NGP800 displays the device information dialog.

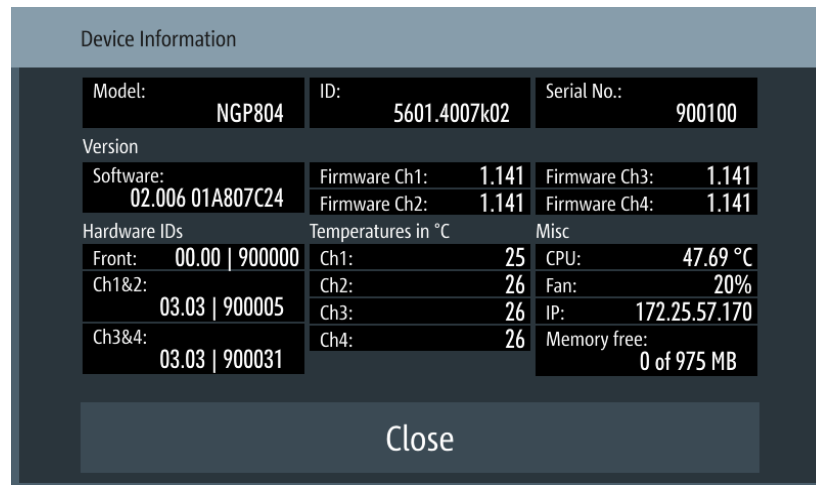

Figure 6-34: Device information dialog

Device information	Description
Model	Model of the instrument.
ID	Instrument orderable part number.
Serial No.	Unique identification number for the instrument.
Version	Software version that is installed in the instrument.
Hardware IDs	Unique serial number of the front and channel boards of the instrument.
Temperatures	Temperature in degrees measured in both Ch 1, Ch 2, Ch 3 and Ch 4. If the temperature exceeded the specification, "Over Temperature Protection" (OTP) is triggered and the respective output channel is turned off.
Misc	Temperature measures for CPU. Instrument IP address. Fan speed and memory capacity in the instrument.

6.15.6 Update Device



Latest instrument firmware is available in the R&S NGP800 product homepage.

1. Select the "Update Device" to update instrument firmware.
The R&S NGP800 displays the update device dialog.

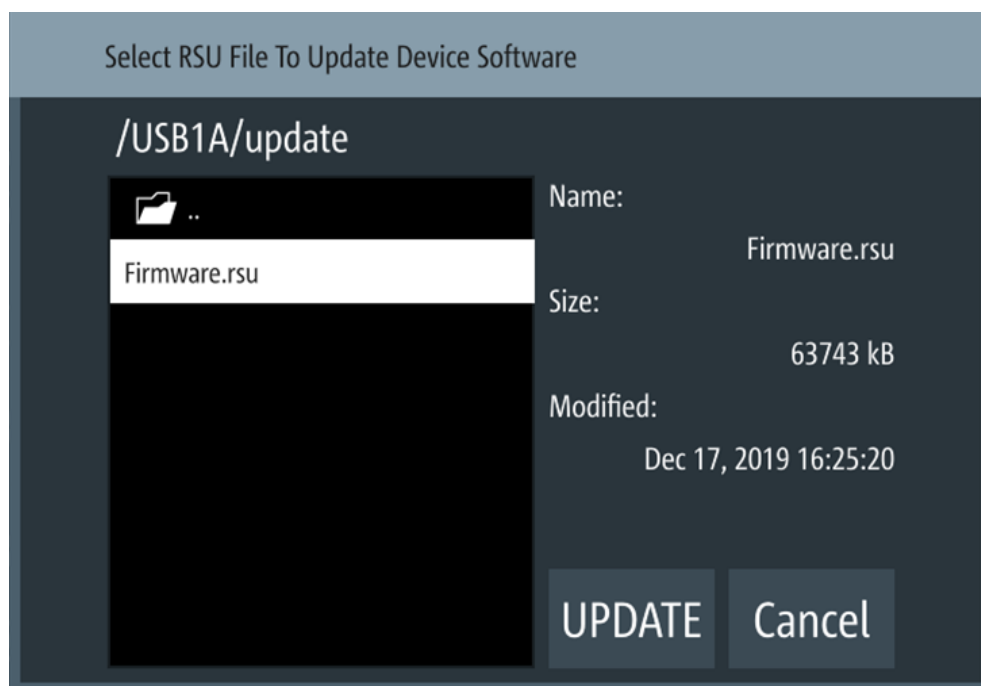

Figure 6-35: Update device dialog

2. Select the source and file location to update instrument firmware.
3. Select "UPDATE" to update the instrument firmware.
The R&S NGP800 updates the instrument firmware accordingly.

6.16 Adjustment



Adjustment shall be done at ambient temperature of $25\text{ °C} \pm 2\text{ °C}$.

The instrument must be operated for at least 30 minutes before executing the adjustment.

Thick wires are recommended for connecting the shunt resistor to avoid huge voltage drop and excessive heating.

For ease of maintenance, the R&S NGP800 provides two adjustment procedures which you can apply on the instrument:

- [Chapter 6.16.1, "Analog In Adjustment"](#), on page 82
- [Chapter 6.16.2, "Channel Adjustment"](#), on page 84

- ▶ Press [Settings] key.
The R&S NGP800 displays the device/channel menu window.

6.16.1 Analog In Adjustment

The "Analog In Adjustment" adjusts the output channel voltage and current when a 0 V to 5 V is applied at the analog input of the terminal block, see "[Digital I/O & analog input connector \(15\)](#)" on page 23.

Depending on the instrument models, up to four analog input pins are adjusted independently.

Table 6-5: Output channel voltage, current for different instrument models

Models	Output channel voltage with 0 V to 5 V applied to analog input pins (ANA IN1, ANA IN2, ANA IN3, ANA IN4)
NGP802, NGP804, NGP814 (Ch 1, Ch 2)	0 V to 32 V, 0A - 20A
NGP822, NGP824, NGP814 (Ch 3, Ch 4)	0 V to 64 V, 0A - 10A

Analog input adjustment setup

Recommended instruments

- Digital multimeter (DMM): 6 ½ digits
- External DC power supply: 1 mV resolution, 0.05 % accuracy with < 500 uVrms ripple

Connect the external DC power supply to the [analog input channel](#) (e.g. ANA_IN1) with respect to the analog ground (AND_GND). Monitor the voltage using digital multimeter.

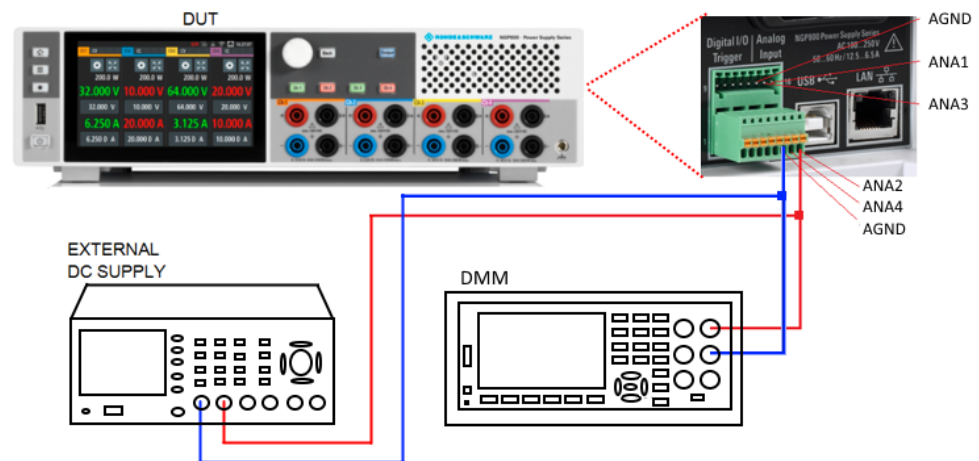

Figure 6-36: Analog input adjustment setup

1. Select the device tab to perform the analog in adjustment routine.
The R&S NGP800 displays the selected "Adjustment - Analog In" dialog.

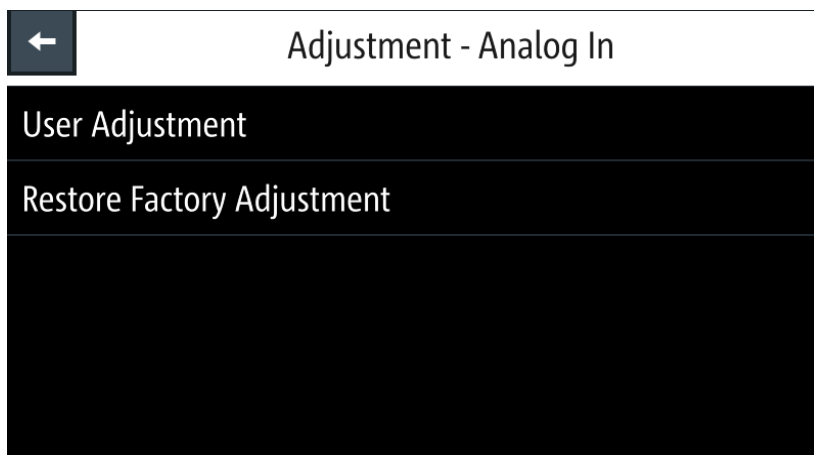
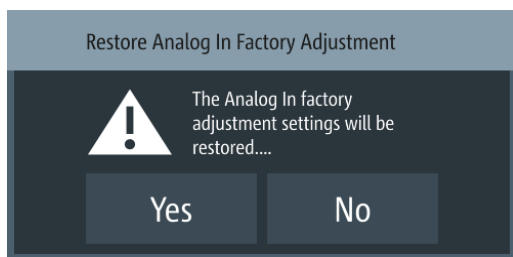

Figure 6-37: Adjustment -Analog In dialog

2. To overwrite user adjustment, select "Restore Factory Adjustment" to restore the analog in factory settings.



Select "Yes" to restore factory adjustment.

3. To proceed analog in adjustment, select "User Adjustment" in [Figure 6-37](#). The R&S NGP800 displays the "ANALOG IN ADJUSTMENT" wizard to guide the adjustment procedures.

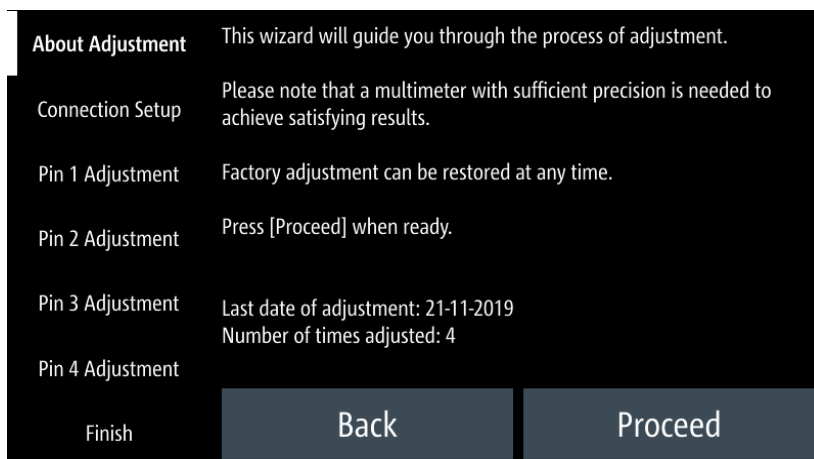

Figure 6-38: Analog in adjustment wizard

4. Setup the adjustment with instruments illustrated in [Figure 6-36](#).

- Follow the on-screen instructions displayed in the [Figure 6-38](#). Supply the required voltage to the analog input and key in the measured value from DMM using the on-screen keypad. See [Figure 6-39](#).

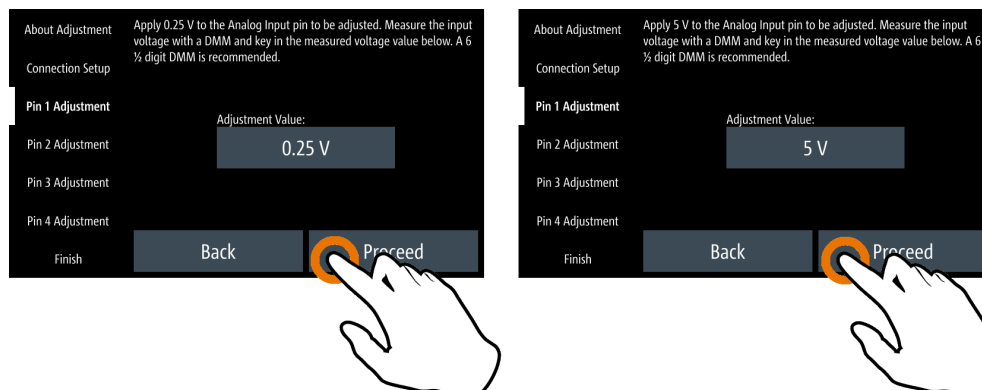
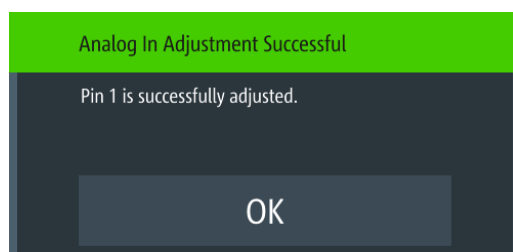
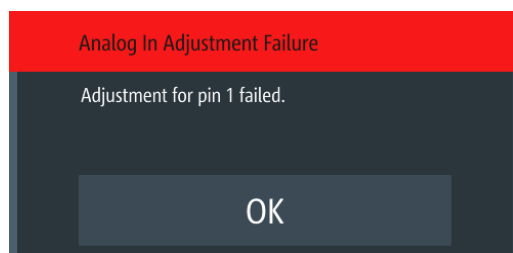

Figure 6-39: Analog in adjustment procedure

- Confirm the entry with **Proceed**.
- Leave the setup connections as open. Select **Proceed** to start the adjustment automatically.
- If adjustment is successful, the R&S NGP800 displays a message to indicate that the adjustment is successful. The R&S NGP800 overwrites the factory or the last analog in adjustment.



- If adjustment failed after repeated tries, contact your local service partner for support.



6.16.2 Channel Adjustment

The "Adjustment" calculates the required adjustment coefficient internally for voltage and current on the selected channel.

Channel adjustment setup

Recommended instruments

- Digital multimeter (DMM): 6 ½ digits
- Shunt resistor: 10 mΩ, at least 25 A rating, 0.02 % accuracy,
- Connect the DMM to the instrument and monitor the measured voltage or current. See [Figure 6-40](#) and [Figure 6-41](#).

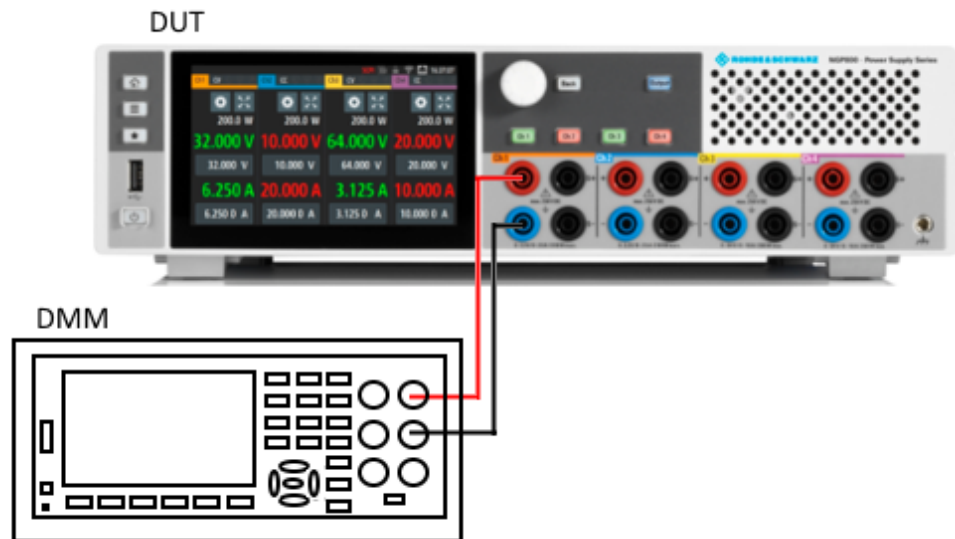

Figure 6-40: Voltage adjustment setup

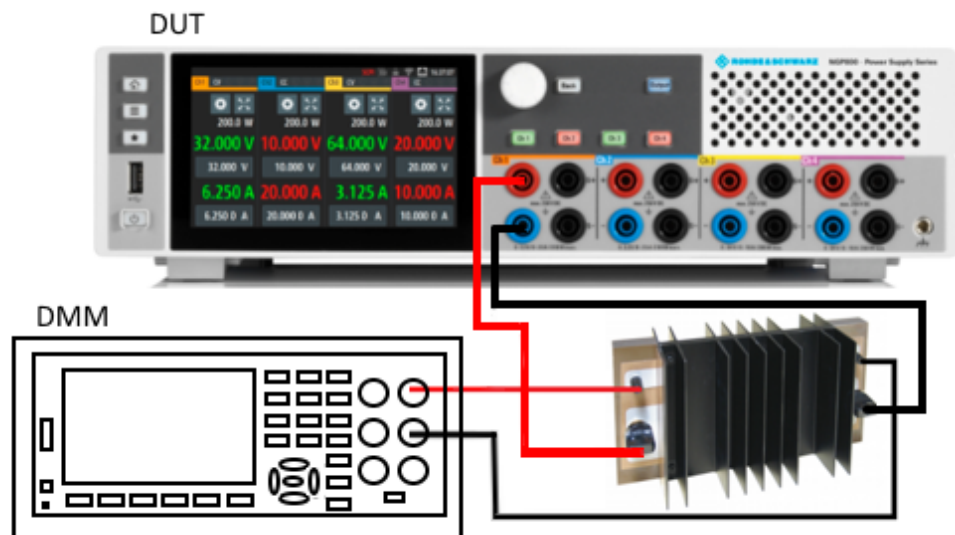

Figure 6-41: Current adjustment setup

1. Select the desired channel tab to perform the required channel adjustment procedures.

The R&S NGP800 displays the selected channel adjustment dialog.



Figure 6-42: Adjustment dialog

- To overwrite user adjustment, select "Restore Factory Adjustment" to restore the channel factory settings.

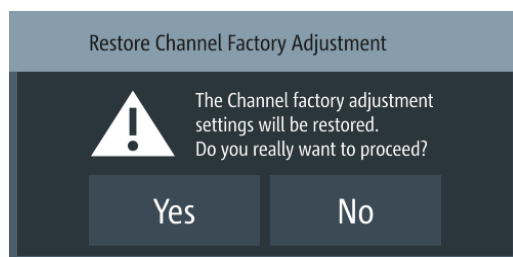

Select "Yes" to restore factory adjustment.

- To proceed channel adjustment, select "User Adjustment" in [Figure 6-42](#). The R&S NGP800 displays the "ADJUSTMENT" wizard to guide the channel adjustment procedures.

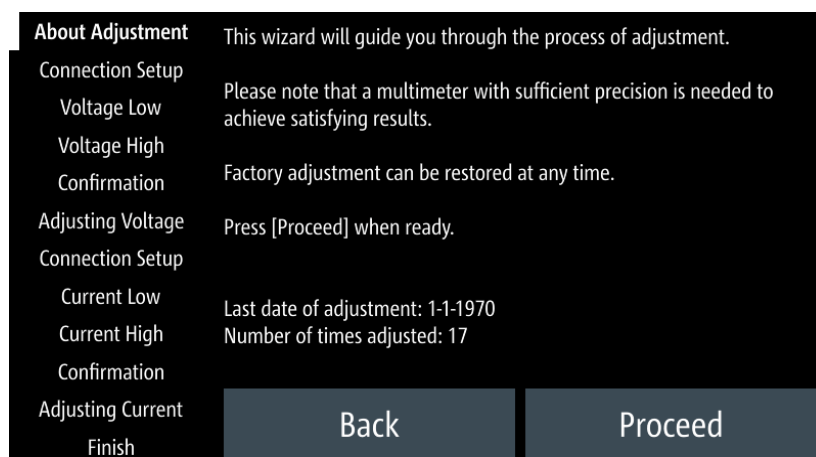

Figure 6-43: Channel adjustment wizard

4. Depending on the types of adjustment (voltage or current), setup the instruments illustrated in [Figure 6-40](#) or [Figure 6-41](#).
5. Follow the on-screen instructions displayed in the [Figure 6-43](#).
The R&S NGP800 applies a low voltage/current followed by a high voltage/current for voltage/current adjustment. Key in the measured value from DMM using the on-screen keypad. See [Figure 6-44](#).

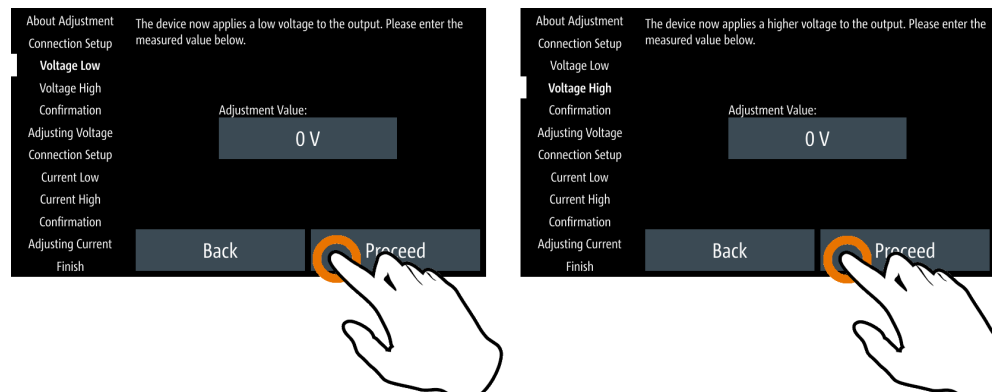

Figure 6-44: Channel adjustment procedure

6. Confirm the entry with .
7. Leave the setup connections as open.
Select "Proceed" to start the voltage adjustment automatically.
8. Follow the on-screen instructions for current adjustment.
9. If adjustment is successful, the R&S NGP800 displays a message to indicate that the adjustment is successful.
The R&S NGP800 overwrites the factory or the last channel adjustment.
10. If adjustment failed after repeated tries, contact your local service partner for support.

7 Remote Control Commands

This chapter provides the description of all remote commands available for the R&S NGP800 series. The commands are sorted according to the menu structure of the instrument. A list of commands in alphabetical order is given in the "List of Commands" at the end of this documentation.

7.1 Common Setting Commands

Common commands are described in the IEEE 488.2 (IEC 625-2) standard. These commands have the same effect and are employed in the same way on different devices. The headers of these commands consist of "*" followed by three letters.

Many common commands are related to the Status Reporting System.

*CLS.....	88
*ESE.....	88
*ESR?.....	89
*IDN?.....	89
*OPC.....	89
*OPT?.....	89
*RST.....	89
*SRE.....	89
*STB?.....	90
*TST?.....	90
*WAI.....	90
*SAV.....	90
*RCL.....	90

*CLS

Clear status

Sets the status byte (STB), the standard event register (ESR) and the `EVENT` part of the `QUESTIONABLE` and the `OPERATION` registers to zero. The command does not alter the mask and transition parts of the registers. It clears the output buffer.

Usage: Setting only

*ESE <Value>

Event status enable

Sets the event status enable register to the specified value. The query returns the contents of the event status enable register in decimal form.

Parameters:

<Value> Range: 0 to 255

***ESR?**

Event status read

Returns the contents of the event status register in decimal form and then sets the register to zero.

Return values:

<Contents> Range: 0 to 255

Usage: Query only

***IDN?**

Identification

Returns the instrument identification.

Return values:

<ID> "Rohde&Schwarz,<device type>,<part number>/<serial number>,<firmware version>"

Usage: Query only

***OPC**

Operation complete

Sets bit 0 in the event status register when all preceding commands have been executed. This bit can be used to initiate a service request. The query writes a "1" into the output buffer when all preceding commands have been executed, which is useful for command synchronization.

***OPT?**

Option identification query

Queries the options included in the instrument. For a list of all available options and their description, refer to the data sheet.

Usage: Query only

***RST**

Reset

Sets the instrument to a defined default status. The default settings are indicated in the description of commands.

Usage: Setting only

***SRE <Contents>**

Service request enable

Sets the service request enable register to the indicated value. This command determines under which conditions a service request is triggered.

Parameters:

<Contents> Contents of the service request enable register in decimal form.
 Bit 6 (MSS mask bit) is always 0.
 Range: 0 to 255

***STB?**

Status byte query

Reads the contents of the status byte in decimal form.

Usage: Query only

***TST?**

Self-test query

Initiates self-tests of the instrument and returns an error code.

Return values:

<ErrorCode> **integer > 0 (in decimal format)**
 An error occurred.
 0
 No errors occurred.

Usage: Query only

***WAI**

Wait to continue

Prevents servicing of the subsequent commands until all preceding commands have been executed and all signals have settled (see also command synchronization and [*OPC](#)).

Usage: Event

***SAV <Number>**

Save

Stores the current instrument settings under the specified number in an internal memory. The settings can be recalled using the command [*RCL](#) with the associated number.

***RCL <Number>**

Recall

Loads the instrument settings from an internal memory identified by the specified number. The instrument settings can be stored to this memory using the command *SAV with the associated number.

7.2 System Settings Commands

The SYSTem subsystem contains the commands for general functions, which do not affect signal generation directly.

SYSTem:BEEPer:CURRent:STATe.....	91
SYSTem:BEEPer:PROTection:STATe.....	92
SYSTem:BEEPer:PROTection[:IMMediate].....	92
SYSTem:BEEPer:WARning:STATe.....	92
SYSTem:BEEPer:WARning[:IMMediate].....	92
SYSTem:COMMunicate:SOCKet:APPLY.....	92
SYSTem:COMMunicate:SOCKet:DHCP.....	93
SYSTem:COMMunicate:SOCKet:GATeway.....	93
SYSTem:COMMunicate:SOCKet:IPADdress.....	93
SYSTem:COMMunicate:SOCKet:MASK.....	93
SYSTem:COMMunicate:WLAN:CONNection[:STATe].....	93
SYSTem:COMMunicate:WLAN:IPADdress.....	94
SYSTem:COMMunicate:WLAN:PASSword.....	94
SYSTem:COMMunicate:WLAN:SSID.....	94
SYSTem:COMMunicate:WLAN[:STATe].....	94
SYSTem:DATE.....	95
SYSTem:KEY:BRIGHtness.....	95
SYSTem:INTerface?.....	95
SYSTem:INTerface:GPIB?.....	95
SYSTem:LOCal.....	95
SYSTem:REMote.....	96
SYSTem:RWLock.....	96
SYSTem:TIME.....	96
SYSTem:TOUCh[:STATe].....	96
SYSTem:UPTime?.....	96

SYSTem:BEEPer:CURRent:STATe <arg0>

Sets "current control" beeper tone.

Parameters:

<mode>	1 0
	1
	Control beeper is activated.
	0
	Control beeper is deactivated.

Example: `SYSTem:BEEPer:CURRent:STATe 1`
 The "CC-Mode Continuous Beep" is activated, a continue beep sound alert when the selected output channel goes into CC mode.

SYSTem:BEEPer:PROTection:STATe <arg0>

Sets "protection" beeper tone.

Parameters:

<mode> 1 | 0
1
 Protection beeper is activated.
0
 Protection beeper is deactivated.

Example: `SYSTem:BEEPer:PROTection:STATe 1`
 The "Protection Tripped Beep" is activated, a single beep alert when a protection tripped event occurs

SYSTem:BEEPer:PROTection[:IMMediate]

Returns a single "protection" beep immediately.

Usage: Event

SYSTem:BEEPer:WARNIing:STATe <arg0>

Enables "error/warning" beep sound.

Parameters:

<state> 1 | 0
1
 Beep sound for "error/warning" is enabled.
0
 Beep sound for "error/warning" is disabled.

SYSTem:BEEPer:WARNIing[:IMMediate]

Returns a single "error/warning" beep immediately.

Usage: Event

SYSTem:COMMunicate:SOCKet:APPLY

Apply LAN configuration settings.

Usage: Event

SYSTem:COMMunicate:SOCKet:DHCP <arg0>

Sets the LAN interface mode.

Parameters:

<mode>	1 0
	1
	DHCP is enabled. Automatic IP address from DHCP server.
	0
	DHCP is disabled. Manually set IP address.

SYSTem:COMMunicate:SOCKet:GATeway <arg0>

Sets or queries gateway for LAN.

Parameters:

<address>	Gateway address.
-----------	------------------

Example: SYSTem:COMMunicate:SOCKet:GATeway?
Return gateway address from LAN.

SYSTem:COMMunicate:SOCKet:IPADdress <arg0>

Sets or queries IP address of the LAN interface.

Parameters:

<address>	IP address.
-----------	-------------

Example: SYSTem:COMMunicate:SOCKet:IPADdress
"192.168.1.128"
Set IP address 192.168.1.128 for the LAN interface.

SYSTem:COMMunicate:SOCKet:MASK <arg0>

Sets or Queries the subnet mask for LAN.

Parameters:

<address>	Subnet address.
-----------	-----------------

Example: SYSTem:COMMunicate:SOCKet:MASK "255.255.0.0"
Set subnet mask 255.255.0.0

SYSTem:COMMunicate:WLAN:CONNection[:STATe] <arg0>

Connects or disconnects WLAN to the predefined wireless access point.

Available only if option R&S NGP-K102.

Parameters:

<mode>	1 0
--------	-------

1

Connect WLAN to the predefined wireless access point.

0

Disconnect WLAN from the predefined wireless access point.

Example:`SYSTem:COMMunicate:WLAN:CONNECTION 0`

Disconnect WLAN from the predefined wireless access point.

SYSTem:COMMunicate:WLAN:IPADdress

Queries IP address for WLAN.

Available only if option R&S NGP-K102.

Example:`SYSTem:COMMunicate:WLAN:IPADdress?`

Return IP address for WLAN.

SYSTem:COMMunicate:WLAN:PASSword <arg0>

Sets or queries password for WLAN.

Available only if option R&S NGP-K102.

Parameters:`<password>` WLAN password.**Example:**`SYSTem:COMMunicate:WLAN:PASSword?`

Return WLAN password.

Usage:

Setting only

SYSTem:COMMunicate:WLAN:SSID <arg0>

Sets or queries SSID of the access point when wireless interface works as a client.

Available only if option R&S NGP-K102.

Parameters:`<ssid>` SSID of access point.**Example:**`SYSTem:COMMunicate:WLAN:SSID?`

Return SSID of access point for WLAN.

SYSTem:COMMunicate:WLAN[:STATe] <arg0>

Enables or disables WLAN state.

Available only if option R&S NGP-K102.

Parameters:`<state>` 1 | 0**1**

Enable WLAN.

0
Disable WLAN.

SYSTem:DATE <year>, <month>, <day>

Sets or queries the system date.

Parameters:

<year> Sets year of the date.

<month> Sets month of the date.

<arg2> Sets day of the date.

Example: SYSTem:DATE 2018, 10, 15
SYSTem:DATE? -> 2018, 10, 15
Returns the system date.

SYSTem:KEY:BRIGhtness <brightness>

Sets or queries the front panel key brightness.

Parameters:

<brightness> Sets the key brightness.

Range: 0.0 to 1.0

Increment: 0.1

*RST: 1.0

Example: SYSTem:KEY:BRIGhtness 1.0
SYSTem:KEY:BRIGhtness? -> 1.0
Returns key brightness value: 1.0.

SYSTem:INTerface?

Queries the available system interface.

Usage: Query only

SYSTem:INTerface:GPIB?

Queries the GPIB interface information.

Usage: Query only

SYSTem:LOCal

Sets the system to front panel control. The front panel control is unlocked.

Usage: Event

SYSTem:REMOte

Sets the system to remote state. The front panel control is locked.

Usage: Event

SYSTem:RWLock

Sets the system to remote state. The front panel control is locked. You are only able to unlock the front panel control via SCPI command SYSTem:LOCAL.

Usage: Event

SYSTem:TIME <hh>, <mm>, <ss>

Sets or queries the system time.

Parameters:

<hh> Sets the hours of the system time.

<mm> Sets the minutes of the system time.

<ss> Sets the seconds of the system time.

Example: SYSTem:TIME 12, 30, 59
SYSTem:TIME? -> 12, 30, 59
Returns system time.

SYSTem:TOUCh[:STATe] <arg0>

Enables or disables touch interface.

Parameters:

<state> 1 | 0

1

Touch interface is activated.

0

Touch interface is deactivated.

SYSTem:UPTime?

Queries system uptime.

Usage: Query only

7.3 Display Commands

The DISPlay subsystem contains the commands for display functions, which do not affect signal generation directly.

DISPlay:BRIGhtness.....	97
DISPlay[:WINDow]:TEXT:CLEar.....	97
DISPlay[:WINDow]:TEXT[:DATA].....	97

DISPlay:BRIGhtness <brightness>
DISPlay:BRIGhtness?

Sets or queries the display brightness.

Parameters:

<brightness> Displays brightness for the instrument.
 Range: 0.0 to 1.0
 Increment: 0.1
 *RST: 0.8

Example:

DISPlay:BRIGhtness 0.5
 DISPlay:BRIGhtness? -> 0.5
 Returns the display brightness value.

DISPlay[:WINDow]:TEXT:CLEar

Clears the text message box on the front display.

Usage: Event

DISPlay[:WINDow]:TEXT[:DATA] <text>

Shows the text message box on the front display.

Setting parameters:

<text> New value for text message box.

Usage: Setting only

7.4 Trigger Commands

The TRIGger subsystem contains the commands for DIO signal triggering.

TRIGger:CHANnel:DIO<IO>.....	97
TRIGger:CONDition:DIO<IO>.....	98
TRIGger:DIRection:DIO<IO>.....	99
TRIGger:LOGic:DIO<IO>.....	100
TRIGger[:ENABle]:DIO<IO>.....	100
TRIGger[:ENABle]:GENeral.....	100
TRIGger[:ENABle]:SELect:DIO<IO>.....	101

TRIGger:CHANnel:DIO<IO> <arg0>

Sets the trigger channel of the specified Digital I/O line.

Suffix:

<IO> 1..8

Parameters:

<channel> CH1 | CH2 | CH3 | CH4 | CHALI

CH1

Ch 1 is set as the trigger channel.

CH2

Ch 2 is set as the trigger channel.

CH3

Ch 3 is set as the trigger channel.

CH4

Ch 4 is set as the trigger channel.

CHALI

All channels are set as the trigger channel.

TRIGger:CONDition:DIO<IO> <arg0>[, <arg1>]

Sets the trigger condition of the specified Digital I/O line.

Suffix:

<IO> 1..8

Parameters:

<mode> OUTPUT | OVP | FUSE | OTP | OPP | VMODe | CMODe | VLEVel | ILEVel | ENABle | INHibit | ARB | RAMP | ANINput | STATistics | LOG | PLEVel

OUTPUT

Output the selected logic level when the output is turned on at the selected channel.

OVP

Output the selected logic level when the selected critical event (OVP) occurs on the selected channel.

FUSE

Output the selected logic level when a fuse tripped event occurs on the selected channel.

OTP

Output the selected logic level when the selected critical event (OTP) occurs on the selected channel.

OPP

Output the selected logic level when the selected critical event (OPP) occurs on the selected channel.

VMODe

Output the selected logic level when the selected channel operates in the CV mode.

CMODe

Output the selected logic level when the selected channel operates in the CC mode.

VLEVel

Output the selected logic level when the voltage level of the selected channel is greater or equal to the set voltage level, i.e. $V_{set} \geq$ set value.

ILEVel

Output the selected logic level when the current level of the selected channel is greater or equal to the set current level, i.e. $I_{set} \geq$ set value.

ENABLE

Selected channel output is turned on when the selected logic level is met.

INHibit

Selected channel output is inhibited when the selected logic level is met.

Note 1: If the selected channel output is put to inhibit state, manual or remote operation on selected channel output is no longer possible .

Note 2: To reverse the inhibit state, remove the source of the trigger signal. You can either disable the affected DIO interface or remove the source from the affected DIO interface at the rear panel.

ARB

Selected channel arbitrary is enabled when the selected logic level is met.

RAMP

Selected channel ramp is enabled when the selected logic level is met.

ANINput

Selected channel analog input is enabled when the selected logic level is met.

STATistics

Selected channel statistic is enabled when the selected logic level is met.

LOG

For output mode - output the selected logic level when logging is enabled.

For input mode - Logging is enabled when the selected logic level is met.

PLEVel

Output the selected logic level when the power level of the selected channel is greater or equal to the set power level, i.e. $P_{level} \geq$ set value.

<arg1>

Mode value.

TRIGger:DIRection:DIO<IO> <arg0>

Sets or queries the specified Digital I/O line to function as Trigger Input/Output.

Suffix:
 <IO> 1..8

Parameters:
 <logic> OUTPut | INPut
 *RST: OUTPut

Example: TRIGger:DIRection:DIO2 OUT

TRIGger:LOGic:DIO<IO> <arg0>

Sets or queries the trigger logic (Active High/Active Low) of the specified Digital I/O line.

Suffix:
 <IO> 1..8

Parameters:
 <logic> LOW | HIGH
 *RST: HIGH

TRIGger[:ENABLE]:DIO<IO> <arg0>

Sets or queries the enable state of the specified Digital I/O line.

Suffix:
 <IO> 1..8

Parameters:
 <state> 1 | 0
1
 Selected Digital I/O line is enabled.
0
 Selected Digital I/O line is disabled.
 *RST: 0

TRIGger[:ENABLE]:GENERAL <arg0>

Sets or queries the enable state of the master on/off of Digital I/O trigger.

Parameters:
 <master_state> 1 | 0
1
 Master state of Digital I/O trigger is enabled.
0
 Master state of Digital I/O trigger is disabled.
 *RST: 0

TRIGger[:ENABLE]:SElect:DIO<IO> <arg0>

Sets or queries the enable state of the specified Digital I/O line.

Suffix:

<IO> 1..8

Parameters:

<state> 1 | 0

1

The specified Digital I/O line is enabled.

0

The specified Digital I/O line is disabled.

7.5 Configuration Commands

The following subsystems contain the commands for channel selection, voltage and current settings for the instrument.

7.5.1 Channel Selection

The `INSTRument:Select` subsystem contains the commands for selecting the output channels.

Each channel of the power supply is considered as separate "instrument", which is required by the SCPI standard. Therefore, the SCPI commands use the `INSTRument` node to select a channel.



You can only address the number of channels a device is equipped with, e.g. a maximum of four channels for the NGP804, NGP824, NGP814 or two channels for the NGP802, NGP822.

Example: Selecting a channel

You can select a channel either with an `OUTput` parameter, or just by the channel number. This example lists all ways how you can select and query a selected channel.

```
// *****
// Select a channel
// *****
INST OUT1
// selects channel 1
INST?
// queries the channel selection
// response: "OUT1"
// *****
// Select a channel by its number
// *****
INST:NSEL 1
// selects channel number 1
INST:NSEL?
// queries number of the channel selection
// response: 1
```

[INSTrument:NSElect](#)..... 102
[INSTrument\[:SElect\]](#)..... 102

INSTrument:NSElect <arg0>

Selects or queries the channel by number.

Setting parameters:

<channel> 1 | 2 | 3 | 4
 Range: 1 to 4

Example: See [Example "Selecting a channel"](#) on page 102.

INSTrument[:SElect] <arg0>

Selects or queries the channel by keyword.

Setting parameters:

<channel> OUT1 | OUTP1 | OUTPut1 | 1 | OUT2 | OUTP2 | OUTPut2 | 2 |
 OUT3 | OUTP3 | OUTPut3 | 3 | OUT4 | OUTP4 | OUTPut4 | 4
 OUT1 | OUTP1 | OUTPut1 | 1
 Selects Channel 1 (Ch 1)
 OUT2 | OUTP2 | OUTPut2 | 2
 Selects Channel 2 (Ch 2)
 OUT3 | OUTP3 | OUTPut3 | 3
 Selects Channel 3 (Ch 3)
 OUT4 | OUTP4 | OUTPut4 | 4
 Selects Channel 4 (Ch 4)

Example: See [Example "Selecting a channel"](#) on page 102.

7.5.2 Safety Limit Setting

The `SOURCE:ALIM` subsystem contains the commands for setting the safety limits of the output channels.

Example: Configuring the safety limit

This example contains all commands to configure and query the voltage and current safety limit.

```
// *****
// Select the channel
// *****
INST OUT1
// *****
// Set upper or lower voltage safety limit
// *****
ALIM 1
//sets the safety limits to enable
ALIM?
//queries the safety limits state
//response: "1"
VOLT:ALIM 15
//sets the safety limits for the upper voltage
VOLT:ALIM?
//queries the safety limits for the upper voltage
//reponse: "15.000"
VOLT:ALIM LOW 0
//sets the safety limits for the lower voltage
VOLT:ALIM?
//queries the safety limits for the lower voltage
//reponse: "0.000//
*****
// Set upper or lower current safety limit
// *****
CURR:ALIM 3
//sets the safety limits for the upper current
CURR:ALIM?
//queries the safety limits for the upper current
//reponse: "3.0000"
CURR:ALIM LOW 0
//sets the safety limits for the lower current
CURR:ALIM?
//queries the safety limits for the lower current
//reponse: "0.0000
```

[SOURCE:ALIMit[:STATe].....	104
[SOURCE:VOLTage[:LEVel][:IMMediate]:ALIMit:LOWer.....	104
[SOURCE:VOLTage[:LEVel][:IMMediate]:ALIMit:UPPer].....	104
[SOURCE:CURRent[:LEVel][:IMMediate]:ALIMit:LOWer.....	105
[SOURCE:CURRent[:LEVel][:IMMediate]:ALIMit:UPPer].....	105

[SOURce:]ALIMit[:STATe] <arg0>

Sets or queries the safety limit state.

Parameters:

<state> 1 | 0
 1
 Activates the safety limit.
 0
 Deactivates the safety limit.

Example: See [Example "Configuring the safety limit"](#) on page 103.

[SOURce:]VOLTage[:LEVeI][:IMMEdiate]:ALIMit:LOWer <New value for voltage>

Sets or queries the lower safety limit for voltage.

Setting parameters:

<voltage> numeric | MIN | MINimum | MAX | MAXimum
 numeric
 Numeric value for safety limit.
 MIN | MINimum
 Min value for lower safety limit.
 MAX | MAXimum
 Max value for lower safety limit.
 Range: 0.000E+00 to 6.4050E+01
 Increment: 0.001
 *RST: 0.000E+00

Example: See [Example "Configuring the safety limit"](#) on page 103.

[SOURce:]VOLTage[:LEVeI][:IMMEdiate]:ALIMit:UPPer] <New value for voltage>

Sets or queries the upper safety limit for voltage.

Setting parameters:

<voltage> numeric | MIN | MINimum | MAX | MAXimum
 numeric
 Numeric value for upper safety limit.
 MIN | MINimum
 Min value for upper safety limit.
 MAX | MAXimum
 Max value for upper safety limit.
 Range: 0.000E+00 to 6.4050E+01
 Increment: 0.001
 *RST: 6.450E+01

Example: See [Example "Configuring the safety limit"](#) on page 103.

[SOURce:]CURRent[:LEVel][:IMMediate]:ALIMit:LOWer <New value for current>

Sets or queries the lower safety limit for current.

Setting parameters:

<current> numeric | MIN | MINimum | MAX | MAXimum

numeric
Numeric value for lower safety limit.

MIN | MINimum
Min value for lower safety limit.

MAX | MAXimum
Max value for lower safety limit.

Range: For up to 32V: 0.0005E+00 to 20.0100E+00. For up
to 64V: 0.0005E+00 to 10.0100E+00

Increment: 0.0005

*RST: 0.0005E+00

Example: See [Example "Configuring the safety limit"](#) on page 103.

[SOURce:]CURRent[:LEVel][:IMMediate]:ALIMit[:UPPer] <New value for current>

Sets or queries the upper safety limit for current.

Setting parameters:

<current> numeric | MIN | MINimum | MAX | MAXimum

numeric
Numeric value for upper safety limit.

MIN | MINimum
Min value for upper safety limit.

MAX | MAXimum
Max value for upper safety limit.

Range: For up to 32V: 0.0005E+00 to 20.0100E+00. For up
to 64V: 0.0005E+00 to 10.0100E+00

Increment: 0.0005

*RST: 0.0005E+00

Example: See [Example "Configuring the safety limit"](#) on page 103.

7.5.3 Remote Sense Setting

The `VOLTage:SENSe` subsystem contains the command for setting the remote sense for the instrument.

[\[SOURce:\]VOLTage:SENSe\[:SOURce\]](#).....106

[SOURce:]VOLTage:SENSe[:SOURce] <arg0>

Sets remote sense detection.

Parameters:

<detection>

AUTO | EXT

AUTO

If remote sense detection is set "AUTO", the detection and enabling of the voltage sense relay automatically kicks in when the connection of remote sense wires (S+, S-) to the input of the load is applied.

EXT

If remote sense detection is set "EXT", internal voltage sense relay in the instrument is switched on and the connection of remote sense wires (S+, S-) to the input of the load become necessary. Failure to connect remote sense can cause overvoltage or unregulated voltage output from the R&S NGP800.

7.5.4 Voltage Setting

The `SOURce:VOLTage` subsystem contains the commands for setting the voltage of the output channels. The default unit is V.

Example: Configuring the output voltage

This example contains all commands to configure and query the output voltage.

```
// *****
// Select the channel
// *****
INST OUT1
// *****
// Set upper or lower voltage safety limit
// *****
ALIM 1
//sets the safety limits to enable
ALIM?
//queries the safety limits state
//response: "1"
VOLT:ALIM 15
//sets the safety limits for the upper voltage
VOLT:ALIM?
//queries the safety limits for the upper voltage
//response: "15.000"
VOLT:ALIM LOW 0
//sets the safety limits for the lower voltage
VOLT:ALIM?
//queries the safety limits for the lower voltage
//response: "0.000"
// *****
// Set the voltage value
// *****
VOLT 10
// selects a channel and sets the voltage
VOLT MAX
VOLT MIN
// sets the voltage to maximum or minimum respectively
VOLT?
// queries the output voltage of a channel
// response: "10.000"
// *****
// Query the range of the voltage values
// *****
VOLT? MIN
// response: "0.000"
VOLT? MAX
// queries the upper and lower limit of the output voltage
// response: "64.050"
// *****
// Increase or decrease the voltage stepwise
// *****
INST OUT1
VOLT:STEP 4
VOLT UP
```

```
// selects the output channel, sets the step width
// and increases the voltage in the selected channel
// from 4 Volts
VOLT DOWN
// decreases the voltage in the selected channel
// from 4 Volts
VOLT:STEP?
// queries the voltage step size
// response: "4.000"
```

[SOURce:]VOLTage[:LEVel][:IMMediate][:AMPLitude]..... 108

[SOURce:]VOLTage[:LEVel][:IMMediate]:STEP[:INCRement]..... 108

[SOURce:]VOLTage[:LEVel][:IMMediate][:AMPLitude] <New value for voltage>

Sets or queries the voltage value of the selected channel.

Parameters:

<voltage> numeric | MIN | MINimum | MAX | MAXimum | UP | DOWN

numeric

Numeric value in V.

MIN | MINimum

Minimum voltage at 0.000 V.

MAX | MAXimum

Maximum voltage at 64.050 V.

UP

Increases voltage by a defined step size. See [SOURce:]VOLTage[:LEVel][:IMMediate]:STEP[:INCRement] on page 108.

DOWN

Decreases voltage by a defined step size. See [SOURce:]VOLTage[:LEVel][:IMMediate]:STEP[:INCRement] on page 108.

Range: 0.000 to 64.050

Example: See [Example "Configuring the output voltage"](#) on page 107.

[SOURce:]VOLTage[:LEVel][:IMMediate]:STEP[:INCRement] <desired stepsize>[,
<Optional default step query>]

[SOURce:]VOLTage[:LEVel][:IMMediate]:STEP[:INCRement]? [<Optional default
step query>]

Sets or queries the incremental step size for the [VOLT UP](#) | [VOLT DOWN](#) command.

Setting parameters:

<stepsize> numeric | DEF | DEFault

numeric

Step value in V.

DEF | DEFault

Default value of stepsize.

Range: 0.001 to 5.000

Increment: 0.001

*RST: 0.100

Default unit: V

Parameters for setting and query:

<stepsize> DEF | DEFault

Queries the default voltage step size.

Example:

```
INST OUT1
VOLT:STEP 0.001
VOLT:STEP DEF
VOLT:STEP? DEF -> 0.10
```

Returns the default stepsize voltage.

See also [Example "Configuring the output voltage"](#) on page 107.

7.5.5 Current Setting

The `SOURce:CURRent` subsystem contains the commands for setting the current limit of the output channels. The default unit is A.

Example: Configuring the current output

```
// *****
// Select the channel
// *****
INST OUT1
// *****
// Set upper or lower current safety limit
// *****
ALIM 1
//sets the safety limits to enable
ALIM?
//queries the safety limits state
//response: "1"
CURR:ALIM 3
//sets the safety limits for the upper current
CURR:ALIM?
//queries the safety limits for the upper current
//reponse: "3.0000"
CURR:ALIM LOW 0.0010
//sets the safety limits for the lower current
CURR:ALIM?
//queries the safety limits for the lower current
//response: "0.0010"
// *****
// Set the current value
// *****
CURR 2
// selects a channel and sets the current
CURR?
// queries the current of the selected channel
// response: 2.0000
// *****
// Query the range of the current values
// *****
CURR? MIN
// response: 0.0001
CURR? MAX
// response: 20.0000
// queries the upper and lower limit of the current
// *****
// Increase or decrease the current stepwise
// *****
INST OUT1
CURR:STEP 1
CURR DOWN
// selects the output channel, sets the step width
// and decreases the current in the selected channel
// by the set 1 Ampere
CURR UP
// increases the current in the selected channel
```

```
// by the set 1 Ampere
CURR:STEP?
// queries the current step size
// response: 1.0000
```

[SOURce:]CURRent[:LEVel][:IMMediate][:AMPLitude]..... 111
[SOURce:]CURRent[:LEVel][:IMMediate]:STEP[:INCRement]..... 112

[SOURce:]CURRent[:LEVel][:IMMediate][:AMPLitude] <New value for current>[,
<return min or max amplitude>]

[SOURce:]CURRent[:LEVel][:IMMediate][:AMPLitude]? [<return min or max
amplitude>]

Sets or queries the current value of the selected channel.

Setting parameters:

<current> numeric | MIN | MINimum | MAX | MAXimum | UP | DOWN

numeric

Numeric value in the range of 0.000 to 20.0100 .

MIN | MINimum

Minimum current at 0.0005 A.

MAX | MAXimum

Depending on the set voltage level, the maximum set current is 20.0100 A.

For voltage range up to 32 V, maximum set current is 20.0100 A.
For voltage range up to 64 V, maximum set current is 10.0100 A.

UP

Increases current by a defined step size. See [SOURce :
]CURRent[:LEVel][:IMMediate]:STEP[:INCRement]
on page 112.

DOWN

Decreases current by a defined step size. See [SOURce :
]CURRent[:LEVel][:IMMediate]:STEP[:INCRement]
on page 112.

Parameters for setting and query:

<current> MIN | MINimum | MAX | MAXimum

MIN | MINimum

Returns minimum current.

MAX | MAXimum

Returns maximum current.

Example: See [Example "Configuring the current output"](#) on page 110.

[SOURce:]CURRent[:LEVel][:IMMediate]:STEP[:INCRement] <desired stepsize>[,
<Optional default step query>]

[SOURce:]CURRent[:LEVel][:IMMediate]:STEP[:INCRement]? [<Optional default
step query>]

Sets or queries the incremental step size for the [CURR UP](#) | [CURR DOWN](#) command.

Setting parameters:

<stepsize> numeric | DEF | DEFault
numeric
 Step value in A.
DEF | DEFault
 Default value of stepsize.
 Range: 0.0001 to 2.000
 Increment: 0.0001
 *RST: 0.010
 Default unit: A

Parameters for setting and query:

<Optional default step DEF | DEFault
 query> Queries the default voltage step size.

Example:

```
INST OUT1
CURR:STEP 0.005
CURR:STEP DEF
VOLT:STEP? DEF -> 0.1000E+00
```

Returns the default stepsize for current.
 See [Example "Configuring the current output"](#) on page 110.

7.5.6 Combined Setting of Voltage and Current Settings

The [APPLY](#) subsystem provides a command that enables you to set the current and voltage of a channel in one step.



The combined voltage and current setting command takes approximately 100 ms, i.e. longer than the setting of a single value.

APPLY <arg0>[, <arg1>, <arg2>]

Sets or queries the voltage and current value of the selected channel.

Parameters:

<voltage> numeric | MIN | MINimum | MAX | MAXimum | DEF | DEFault
numeric
 Numeric value for voltage in the range of 0.000 to 64.050.
MIN | MINimum
 Min voltage at 0.000 V.

	<p>MAX MAXimum Max value for voltage at 64.050V.</p> <p>DEF DEFault Default voltage. *RST: 1.000 Default unit: V</p>
<current>	<p>numeric MIN MINimum MAX MAXimum DEF DEFault</p> <p>numeric Numeric value for current in the range of 0.000 to 20.0100.</p> <p>MIN MINimum Min current at 0.000 A.</p> <p>MAX MAXimum Max value for current at 0.0100 A.</p> <p>DEF DEFault Numeric value for current. *RST: 1.000 Default unit: A</p>
<output>	<p>OUT1 OUTP1 OUTPut1 OUT2 OUTP2 OUTPut2 OUT3 OUTP3 OUTPut3 OUT4 OUTP4 OUTPut4</p> <p>OUT1 OUTP1 OUTPut1 Selects output for channel 1.</p> <p>OUT2 OUTP2 OUTPut2 Selects output for channel 2.</p> <p>OUT3 OUTP3 OUTPut3 Selects output for channel 2.</p> <p>OUT4 OUTP4 OUTPut4 Selects output for channel 4.</p>
Example:	<pre>INST OUT1 APPL 6,2</pre> <p>Sets 6 V and 2 A to output of channel 1.</p> <pre>APPL? -> 6.000, 2.000</pre> <p>Queries the voltage and current of the selected channel.</p>

7.5.7 Output Setting

The `OUTPut` subsystem contains the commands for activating the output channels.

Example: Activating the channels

You can activate a selected channel and turn on or off the outputs either individually or all outputs simultaneously. This example lists all ways how you can activate and query the outputs.

```
// *****
// Activate a channel
// *****
INST OUT1
OUTP:SEL 1
// activates the selected channel
OUTP 1
// activates channel 1 and its output
OUTP?
// queries the output state
// response: 1
// *****
// Turn on all selected channels simultaneously
// *****
INST:OUT1
VOLT 12
CURR 0.1
OUTP:SEL 1
INST:OUT2
VOLT 12
CURR 0.2
OUTP:SEL 1
// selects channels 1 and 2
// sets the voltage and current values for both channels
// activates both channels
OUTP:GEN 1
// turns on the output of both channels
```

OUTPut:GENeral[::STATe]	114
OUTPut[::STATe]	115
OUTPut:DELay:DUration	115
OUTPut:DELay[::STATe]	115
OUTPut:SELect	116

OUTPut:GENeral[::STATe] <arg0>

Sets or queries all previous selected channels simultaneously

Parameters:

<state> OFF | ON | 0 | 1
OFF | 0
 Switches off previous selected channels simultaneously.
ON | 1
 Switches on previous selected channels simultaneously.

Example: See [Example "Activating the channels"](#) on page 114.

OUTPut[:STATe] <arg0>

Sets or queries the output state of the previous selected channels.

Parameters:

<state> OFF | ON | 0 | 1
OFF | 0
 Switches off previous selected channels.
ON | 1
 Switches on previous selected channels.

Example: See [Example "Activating the channels"](#) on page 114.

OUTPut:DELAy:DURation <New value for sequence delay (selected channel)>

Sets or queries the duration for output delay.

Setting parameters:

<duration> numeric | MIN | MINimum | MAX | MAXimum
numeric
 Numeric value of the duration in seconds.
MIN | MINimum
 Minimum value of the duration at 0.001 seconds.
MAX | MAXimum
 Maximum value of the duration at 10.00 seconds.
 Range: 0.001 to 10.00
 *RST: 0.001
 Default unit: s

Example: OUTPut:DELAy:DURation 1
 OUTPut:DELAy:DURation? -> 1
 Returns output delay of 1 s.

OUTPut:DELAy[:STATe] <arg0>

Sets or queries the output delay state for the selected channel.

Parameters:

<state> OFF | ON | 0 | 1
OFF | 0
 Deactivates output delay for the selected channel.
ON | 1
 Activates output delay for the selected channel.

Example: OUTPut:DELAy 1
 OUTPut:DELAy? -> 1
 Returns output delay state as on.

OUTPut:SElect <arg0>

Sets or queries the output state of selected channel.

Parameters:

<state> OFF | ON | 0 | 1
 OFF | 0
 Deactivates the selected channel.
 ON | 1
 Activates the selected channel.
 *RST: OFF | 0

Example: See [Example "Activating the channels"](#) on page 114.

7.5.8 OCP Setting

The FUSE subsystem contains the commands for overcurrent protection parameters such as activating fuses and setting fuse parameters of the output channels. The default unit is A.



The delay function of the fuses takes effect when the corresponding channel is activated (output on).

Example: Configuring fuses

This example contains all commands to configure and query the fuse states and settings.

```
// *****
// Activate a fuse
// *****
INST OUT1
FUSE 1
// selects a channel and activates the overcurrent protection
FUSE?
// queries the state of the overcurrent protection in the selected channel
// response: 1
// *****
// Set a delay time for the overcurrent protection. The delay time
// takes effect when the channel output is turned on.
// *****
FUSE:DEL 50
// sets 50 ms delay for the overcurrent protection and
// turns on the output of the channel
overcurrent protection?
// queries the currently set delay time of the overcurrent protection
// in the selected channel
// response: 50
FUSE:DEL MAX
```

```

FUSE:DEL MIN
// sets the delay time to maximum, minimum respectively
// *****
// Query the range of the overcurrent protection delay time
// *****
FUSE:DEL? MIN
// response: 0
FUSE:DEL? MAX
// queries the upper and lower limit of the
// overcurrent protection delay time in ms
// response: 10000
// *****
// Set a initial delay time for the overcurrent protection. During
// the timeframe, overcurrent protection tripping is inhibited.
// *****
FUSE:DEL:INIT 100
// sets 100 ms for the initial overcurrent protection delay
FUSE:DEL:INIT?
// queries the currently set initial overcurrent protection delay
// in the selected channel
// response: 100
FUSE:DEL:INIT MAX
FUSE:DEL:INIT MIN
// sets the initial overcurrent protection delay to maximum, minimum respectively
// *****
// Query the range of the overcurrent protection delay time
// *****
FUSE:DEL:INIT? MIN
// response: 10
FUSE:DEL:INIT? MAX
// queries the upper and lower limit of the
// overcurrent protection delay time in ms
// response: 60000

// *****
// Query a tripped overcurrent protection
// *****
INST OUT1
FUSE:TRIP?
//queries whether the OCP in channel 1 has tripped
//response: 1 OCP is tripped
//response: 0 OCP is not tripped
FUSE:TRIP:CLear
//resets a tripped OCP in the selected channel

// *****
// Link the electronic overcurrent protection of the channels logically
// *****
INST OUT1
FUSE:LINK 2

```



```

// links the overcurrent protection of channel 1 with channel 2
FUSE:LINK?
// queries the combined overcurrent protection of the selected channel

// *****
// Unlink linked overcurrent protection
// *****
FUSE:UNLink 2
FUSE:LINK?
// queries the combined overcurrent protection of the selected channel
//response 0

FUSE:TRIPped:CLEar..... 118
FUSE:DELAy:INITial..... 118
FUSE:DELAy:BLOWing]..... 119
FUSE:LINK..... 119
FUSE:TRIPped?..... 119
FUSE:UNLink..... 119
FUSE[:STATe]..... 120

```

FUSE:TRIPped:CLEar

Resets the OCP state of the selected channel. If an OCP event has occurred before, the reset also erases the message on the display.

Example: See [Example "Configuring fuses"](#) on page 116.

Usage: Event

FUSE:DELAy:INITial <New value for voltage>

Sets the initial fuse delay time once output turns on.

Parameters:

<duration> numeric | MIN | MINimum | MAX | MAXimum

numeric

Numeric value for initial fuse delay.

MIN | MINimum

Min value for initial fuse delay.

MAX | MAXimum

Max value for initial fuse delay.

Range: 0.00 to 60.00

*RST: 0

Default unit: s

Example: See [Example "Configuring fuses"](#) on page 116.

FUSE:DElay[:BLOWing] <New value for voltage>

Sets the fuse delay time.

Parameters:

<duration> numeric | MIN | MINimum | MAX | MAXimum

numeric
Numeric value for the initial fuse delay.

MIN | MINimum
Min value for initial fuse delay.

MAX | MAXimum
Max value for initial fuse delay.

Range: 0.00 to 10.00
*RST: 0
Default unit: s

Example: See [Example "Configuring fuses"](#) on page 116.

FUSE:LINK <arg0>...**FUSE:LINK?**

Sets or queries the fuses of several selected channels (fuse linking).

Parameters for setting and query:

<arg0> 0 | 1 | 2 | 3 | 4

0 - Link all other channels to the previously selected channel.

Example:

```
INST OUT1; :FUSE:LINK 2
Channel 2 is linked with channel 1
INST OUT1; :FUSE:LINK?
Returns a comma-separated list of all channels linked to channel 1.
See Example "Configuring fuses" on page 116.
```

FUSE:TRIPped?

Queries the OCP state of the selected channel.

Example: See [Example "Configuring fuses"](#) on page 116.

```
FUSE:TRIP?
Response 1, the OCP is tripped.
Response 0, the OCP is not tripped.
```

Usage: Query only

FUSE:UNLink <arg0>...

Unlinks fuse linking from the other channels (Ch 1, Ch 2, Ch 3 or Ch 4).

See [Example "Configuring fuses"](#) on page 116.

Parameters for setting and query:

<arg0> 0 | 1 | 2 | 4 | 3

0 - Unlink all other channels to the previously selected channel.

Example:

FUSE:UNL 1

Fuse linking is unlinked from channel 1

Usage:

Setting only

FUSE[:STATe] <arg0>

Sets or queries the state for over current protection (OCP).

See [Example "Configuring fuses"](#) on page 116.

Parameters:

<arg0> 1 | 0

1

Activates the OCP state.

0

deactivates the OCP state.

Example:

FUSE 1

Activates the OCP.

7.5.9 OVP Setting

The `VOLTage:PROTection` subsystem contains the commands for setting the over-voltage protection parameters for the output channels. The default unit is V.

Example: Configuring the overvoltage protection

```

// *****
// Set the overvoltage protection value
// *****
INST OUT1
VOLT:PROT 1
//activates the OVP of the previous selected channel
VOLT:PROT:LEV 5
// selects a channel and sets the OVP
VOLT:PROT:LEV?
// queries the output overvoltage value of a channel
// response: 5
VOLT:PROT?
// queries the OVP state of the previous selected channel
// response: 1
VOLT:PROT:LEV MAX
VOLT:PROT:LEV MIN
// sets the overvoltage protection to maximum,
// or minimum respectively
// *****
// Query the range of the overvoltage protection values
// *****
VOLT:PROT:LEV? MIN
// response: 0.100
VOLT:PROT:LEV? MAX
// queries the upper and lower limit
// response: 64.050
// *****
// Query a tripped overvoltage protection
// *****
INST OUT1
VOLT:PROT:TRIP?
// queries whether the OVP in channel 1 has tripped
// response: 1 OVP is tripped
// response: 0 OVP is not tripped
VOLT:PROT:CLEAr
// resets a tripped OVP in the selected channel
// *****
// Set the overvoltage protection mode
// *****
INST OUT1
VOLT:PROT:MODE PROT
// sets OVP protected mode for channel1
VOLT:PROT:MODE PROT?
// queries the OVP mode
// response: "protected"

```

[SOURce:]VOLTage:PROTection[:STATe].....	122
[SOURce:]VOLTage:PROTection:CLEar.....	122
[SOURce:]VOLTage:PROTection:LEVel.....	122
[SOURce:]VOLTage:PROTection:TRIPped?.....	123

[SOURce:]VOLTage:PROTection[:STATe] <En/Disable volt protection>

Sets or queries the OVP state of the previous selected channel.

Parameters:

<state> OFF | ON | 0 | 1
 OFF | 0
 OVP is deactivated
 ON | 1
 OVP is activated

Example: See [Example "Configuring the overvoltage protection"](#) on page 121.

[SOURce:]VOLTage:PROTection:CLEar

Resets the OVP state of the selected channel. If an OVP event has occurred before, the reset also erases the message on the display.

Example: See [Example "Configuring the overvoltage protection"](#) on page 121.

Usage: Event

[SOURce:]VOLTage:PROTection:LEVel [<New value for voltage protection>]

Sets or queries the overvoltage protection value of the selected channel.

Parameters:

<voltage> numeric | MIN | MINimum | MAX | MAXimum | DEF | DEFault
 numeric
 Numeric value for the overvoltage protection value in V.
 MIN | MINimum
 Minimum value for the overvoltage protection value at 0.000 V.
 MAX | MAXimum
 Maximum value for the overvoltage protection value at 64.050 V.
 Range: 0.000 to 64.050
 *RST: 64.050
 Default unit: V

Example: See [Example "Configuring the overvoltage protection"](#) on page 121.

[SOURce:]VOLTage:PROTection:TRIPped?

Queries the OVP state of the selected channel.

Example: See [Example "Configuring the overvoltage protection"](#) on page 121.

VOLT:PROT:TRIP?

Response 1, the OVP is tripped.

Response 0, the OVP is not tripped.

Usage: Query only

7.5.10 OPP Setting

The `POWer:PROTection` subsystem contains the commands for setting the over-power protection parameters for the output channels. The default unit is W.

Example: Configuring the overpower protection

```
// *****
// Set the overpower protection value
// *****
INST OUT1
POW:PROT 1
//activates the OPP of the previous selected channel
POW:PROT:LEV 5
// selects a channel and sets the OPP
POW:PROT:LEV?
// queries the output overvoltage value of a channel
// response: 5
POW:PROT?
// queries the OPP state of the previous selected channel
// response: 1
POW:PROT:LEV MAX
POW:PROT:LEV MIN
// sets the overvoltage protection to maximum,
// or minimum respectively
// *****
// Query the range of the overpower protection values
// *****
POW:PROT:LEV? MIN
// reponse: 0.0
POW:PROT:LEV? MAX
// queries the upper and lower limit
// reponse: 60.0
// *****
// Query a tripped overpower protection
// *****
INST OUT1
POW:PROT:TRIP?
// queries whether the OPP in channel 1 has tripped
// response: 1 OPP is tripped
// response: 0 OPP is not tripped
POW:PROT:CLEAr
// resets a tripped OPP in the selected channel
```

[SOURce:]POWer:PROTection[:STATe].....	124
[SOURce:]POWer:PROTection:CLEAr.....	125
[SOURce:]POWer:PROTection:LEVel.....	125
[SOURce:]POWer:PROTection:TRIPped?.....	125

[SOURce:]POWer:PROTection[:STATe] <arg0>

Sets or queries the OPP state of the previous selected channel.

Parameters:

<state> OFF | ON | 0 | 1

OFF | 0

OPP is deactivated

ON | 1

OPP is activated

Example: See [Example "Configuring the overpower protection"](#) on page 124.

[SOURce:]POWER:PROTection:CLEar

Resets the OPP state of the selected channel. If an OPP event has occurred before, the reset also erases the message on the display.

Example: See [Example "Configuring the overpower protection"](#) on page 124.

Usage: Event

[SOURce:]POWER:PROTection:LEVel [<New value for voltage protection>]

Sets or queries the overvoltage protection value of the selected channel.

Parameters:

<power> numeric | MIN | MINimum | MAX | MAXimum | DEF | DEFault

numeric

Numeric value of the power protection level in watts.

MIN | MINimum

Minimum value of the power protection level at 0.00 W.

MAX | MAXimum

Maximum value of the power protection level at 200.00 W.

DEF | DEFault

Default value of the power protection level at 200.00 W.

Range: 0.00 to 200.00

*RST: 200.00

Default unit: W

Example: See [Example "Configuring the overpower protection"](#) on page 124.

[SOURce:]POWER:PROTection:TRIPped?

Queries the OPP state of the selected channel.

Example: See [Example "Configuring the overpower protection"](#) on page 124.

POW:PROT:TRIP?

Response 1, the OPP is tripped.

Response 0, the OPP is not tripped.

Usage: Query only

7.5.11 Reset Protection Tripped State

The `Protection` subsystem contains the command to reset the protection tripped state.

[SOURCE:]PROTECTION:CLEAR

Reset protection tripped state.

Usage: Event

7.5.12 Tracking Setting

The `TRACKing` subsystem contains the commands for changes made on reference channel are applied to the tracked channels.

<code>TRACKing[:ENABLE]:CH<CHANNEL></code>	126
<code>TRACKing[:ENABLE]:GENeral</code>	126
<code>TRACKing[:ENABLE]:SELect:CH<CHANNEL></code>	126

TRACKing[:ENABLE]:CH<CHANNEL> <arg0>

Sets or queries the tracking status on selected channel.

Suffix:

<CHANNEL> 1..4

Parameters:

<arg0> 0 | 1

0

Tracking is disabled on specified channel.

1

Tracking is enabled on specified channel.

TRACKing[:ENABLE]:GENeral <arg0>

Sets or queries the status of the master tracking state.

Parameters:

<arg0> 0 | 1

0

Master tracking is disabled

1

Master tracking is enabled

TRACKing[:ENABLE]:SELect:CH<CHANNEL> <arg0>

Sets or queries the status of tracking soft enable on specific channel.

Suffix:	
<CHANNEL>	1..4
Parameters:	
<arg0>	0 1
	0
	Tracking is disabled
	1
	Tracking is enabled

7.6 Measurement Commands

The MEASure subsystem provides commands to query the voltage and current values of a channel.

MEASure[:SCALar]:ENERgy?	127
MEASure[:SCALar]:STATistic:COUNT?	127
MEASure[:SCALar]:STATistic:RESet	128
MEASure[:SCALar]:CURRent[:DC]?	128
MEASure[:SCALar]:CURRent[:DC]:AVG?	128
MEASure[:SCALar]:CURRent[:DC]:MAX?	128
MEASure[:SCALar]:CURRent[:DC]:MIN?	128
MEASure[:SCALar]:CURRent[:DC]:STATistic?	128
MEASure[:SCALar]:POWer?	128
MEASure[:SCALar]:POWer:AVG?	129
MEASure[:SCALar]:POWer:MAX?	129
MEASure[:SCALar]:POWer:MIN?	129
MEASure[:SCALar]:POWer:STATistic?	129
MEASure[:SCALar][:VOLTage][:DC]?	129
MEASure[:SCALar][:VOLTage][:DC]:AVG?	129
MEASure[:SCALar][:VOLTage][:DC]:MAX?	129
MEASure[:SCALar][:VOLTage][:DC]:MIN?	129
MEASure[:SCALar][:VOLTage][:DC]:STATistic?	130

MEASure[:SCALar]:ENERgy?

Queries the measured the current released energy value of the previous selected channel.

Example: MEAS:ENER? -> 5.382E+00 (value in Wh)

Usage: Query only

MEASure[:SCALar]:STATistic:COUNT?

Returns the number of samples measured in the statistics for voltage/current/power

Usage: Query only

MEASure[:SCALar]:STATistic:RESet

Resets the minimum, maximum and average statistic values for voltage, current, and power.

Additionally this command resets the measured energy.

Usage: Event

MEASure[:SCALar]:CURRent[:DC]?

Queries the currently measured current of the selected channel.

Example: MEAS:CURR? -> 1.000E +00

Usage: Query only

MEASure[:SCALar]:CURRent[:DC]:AVG?

Queries the average measured output current.

Usage: Query only

MEASure[:SCALar]:CURRent[:DC]:MAX?

Queries the maximum measured output current.

Usage: Query only

MEASure[:SCALar]:CURRent[:DC]:MIN?

Queries the minimum measured output power.

Usage: Query only

MEASure[:SCALar]:CURRent[:DC]:STATistic?

Queries the current statistics of the selected channel

Usage: Query only

MEASure[:SCALar]:POWer?

Queries the currently emitted power of the selected channel

Example: MEAS:POW? -> 3.00E+00

Usage: Query only

MEASure[:SCALar]:POWer:AVG?

Queries the average measured output power.

Usage: Query only

MEASure[:SCALar]:POWer:MAX?

Queries the maximum measured output power.

Usage: Query only

MEASure[:SCALar]:POWer:MIN?

Queries the minimum measured output power.

Usage: Query only

MEASure[:SCALar]:POWer:STATistic?

Queries the power statistics of the selected channel.

Usage: Query only

MEASure[:SCALar][:VOLTage][:DC]?

Queries the currently measured voltage of the selected channel.

Example: MEAS:VOLT? -> 1.000E+00

Usage: Query only

MEASure[:SCALar][:VOLTage][:DC]:AVG?

Queries the average measured output voltage.

Usage: Query only

MEASure[:SCALar][:VOLTage][:DC]:MAX?

Queries the maximum measured output voltage.

Usage: Query only

MEASure[:SCALar][:VOLTage][:DC]:MIN?

Queries the minimum measured output voltage.

Usage: Query only

MEASure[:SCALar][:VOLTage][:DC]:STATistic?

Queries the voltage statistics of the selected channel.

Usage: Query only

7.7 Advanced Operating Commands

The following shows the subsystem that contains the commands for configuring the , [QuickArb](#), [EasyRamp](#), [Analog Input](#) and [Adjustment](#) functions.

7.7.1 Arbitrary

The `ARBITrary` subsystem contains the commands for configuring an arbitrary sequence for the output channels.

Example: Configuring an arbitrary sequence

This programming example generates an arbitrary sequence for a selected channel. The sequence starts at 1 V and 1 A for 1 sec, and both values are incremented each second by 1. The generated arbitrary waveform is transferred to Ch1. When activated, the R&S NGP800 provides the arbitrary waveform at the output of the selected channel, and repeats it 10 times.

```
// *****
// Define and start the arbitrary sequence
// *****
INST OUT1
ARB:BLOC:DATA 1,1,1,0,2,2,1,0,3,3,1,0
// selects channel1
// defines the sequence, i.e. starting at 1V, 1A for 1sec,
// and increments the voltage and current each second by 1
// ARB:BLOC:DATA? queries the arb data
ARB:BLOC:REP 1
// sets the repetition rate
// ARB:BLOC:REP? queries the set number of repetitions
ARB:SEQ:REP 10
//sets the sequence repetition
//ARB:SEQ:REP? queries the set number of sequence repetitions
ARB:SEQ:BEH:END HOLD
//sets the arbitrary endpoint behavior, when the arbitrary function is finished
//ARB:SEQ:BEH:END? queries the endpoint behaviour
ARB:SEQ:TRAN
// transfers the arbitrary points to channel
ARB ON
//Enable the arbitrary sequence
//ARB? queries the arb status
OUTP ON
// starts the sequence in channel 1
//turns on the output
```

ARbitrary:BLOCK:CLEAr.....	132
ARbitrary:BLOCK.....	132
ARbitrary:BLOCK:DATA.....	132
ARbitrary:BLOCK:ENDPoint?.....	132
ARbitrary:BLOCK:FNAME.....	133
ARbitrary:BLOCK:REPetitions.....	133
ARbitrary[::STATe].....	133
ARbitrary:CLEAr.....	134
ARbitrary:DATA.....	134
ARbitrary:SEquence:ENDPoint?.....	134
ARbitrary:FNAME.....	134
ARbitrary:LOAD.....	135
ARbitrary:REPetitions.....	135
ARbitrary:SAVE.....	135
ARbitrary:SEquence:BEHavior:END.....	136

ARbitrary:SEquence:REPetitions	136
ARbitrary:SEquence:TRANsfer	136
ARbitrary:TRIGgered[:STATE]	136

ARbitrary:BLOCK:CLEar

Clears a file selected for the block under channel arbitrary settings.

See also [ARbitrary:BLOCK](#) on page 132.

Example:

```
INST OUT1
ARB:BLOC 1
ARB:BLOCK:CLE
Clear the file in block 1 for Ch 1.
```

Usage: Event

ARbitrary:BLOCK <>

Select individual block between 1 to 8 in an arbitrary sequence.

Parameters:

<block> 1..8

ARbitrary:BLOCK:DATA <>...

Define the data points for a whole block.

Parameters:

<data> voltage1, current1, time1, interpolation mode1, voltage2, current2, time2, interpolation mode2, ...

Voltage and current settings depending on the instrument type. If the interpolation mode is sets to 1, it indicates that the mode is activated. If the interpolation mode is sets to 0, it indicates that the mode is not activated.

Example:

```
INST OUT1
ARB:BLOC 1
ARB:BLOCK:DATA 1,1,1,0,2,2,1,0,3,3,1,0
3 data points (voltage, current, time, interpolation) are written to
data block 1, Ch 1.
```

ARbitrary:BLOCK:ENDPoint?

Queries the number of data points of the block of arbitrary data.

Example:

```
INST OUT1
ARB:BLOC 1
ARB:BLOCK:ENDP?
Return the number of data points for block 1 of Ch 1.
```

Usage: Query only

ARbitrary:BLOCK:FNAME <>[, <>]

ARbitrary:BLOCK:FNAME? <>[, <>]

Sets or queries the filename for block of arbitrary data.

Parameters for setting and query:

<filename> Filename of the arbitrary function.

<location> INT | EXT | DEF

INT

Internal memory

EXT

USB stick

DEF

Internal memory

Example:

```
INST OUT1
ARB:BLOC 1
ARB:BLOCK:FNAM "01.CSV"
ARB:BLOCK:FNAM? INT -> "01.CSV"
```

ARbitrary:BLOCK:REPetitions <>

Sets or queries the number of repetitions of the block of arbitrary data.

Parameters:

<repetitions> Repetition of the block of arbitrary data.

Example:

```
INST OUT1
ARB:BLOC 1
ARB:BLOCK:REP 0
Set repetition of infinity to block 1 of Ch 1.
```

ARbitrary[::STATE] <>

Sets or queries the arbitrary function for the previous selected channel.

Parameters:

<state> OFF | ON | 1 | 0

ON | 1

Arbitrary function is activated.

OFF | 0

Arbitrary function is deactivated.

*RST: OFF | 0

Example:

```
ARB ON
ARB? -> 1
Arbitrary function of Ch1 is activated.
See Example "Configuring an arbitrary sequence" on page 131.
```

ARbitrary:CLEar

Clears the previous defined arbitrary waveform data for the selected channel.

Example: See [Example "Configuring an arbitrary sequence"](#) on page 131.

Usage: Event

ARbitrary:DATA <>...

Sets or queries the arbitrary points for the previous selected channel. Max. 1024 arbitrary points can be defined. The dwell time between 2 arbitrary points is specified from 1 ms to 60 ms.

Parameters:

<data> voltage1, current1, time1, interpolation mode1, voltage2, current2, time2, interpolation mode2, ...

Voltage and current settings depending on the instrument type. If the interpolation mode is sets to 1, it indicates that the mode is activated. If the interpolation mode is sets to 0, it indicates that the mode is not activated.

Example:

```
INST OUT1
```

```
ARB:DATA 10,1,0.5,0
```

Defines one arbitrary point with: Voltage1 = 10 V and Current1 = 1 A, Time1 = 500 ms and Interpolation mode1 = 0 (disabled).

```
ARB:DATA? -> 10.000, 1.000, 0.50, 1
```

Returns defined arbitrary points for the previous selected channel.

See [Example "Configuring an arbitrary sequence"](#) on page 131.

ARbitrary:SEquence:ENDPoint?

Queries the total number of points of the arbitrary sequence.

Usage: Query only

ARbitrary:FNAME <>[, <>]

ARbitrary:FNAME? <>[, <>]

Sets or queries the file name and storage location for the arbitrary function.

Parameters for setting and query:

<filename> Filename of the arbitrary function.

<location> INT | EXT | DEF

INT

Internal memory

EXT

USB stick

DEF

Internal memory

Example: ARB:FNAM "01.CSV"
ARB:FNAM? INT -> "01.CSV"

ARbitrary:LOAD

Loads an arbitrary table from a file (filename specified with ARB:FNAM)

Example: INST OUT1
ARB:DATA 10,1,0.5,0
ARB:REP 10
ARB:FNAM "ARB03.CSV",INT
ARB:SAVE
ARB:LOAD
Loads an arbitrary data from filename ARB03.CSV.

Usage: Event

ARbitrary:REPetitions <>

Sets or queries the repetition rate of the defined arbitrary waveform for the previous selected channel. Up to 65535 repetitions are possible. If the repetition rate "0" is selected the arbitrary waveform of the previous selected channel is repeated infinitely.

Parameters:

repetition_rate Range: 0 to 65535
The "0" indicates infinite repetition.

Example: INST OUT1
ARB:REP 10
ARB:REP? -> 10
The returned repetition rate of the Ch1 arbitrary waveform is 10.

ARbitrary:SAVE

Saves the current arbitrary table to a file (filename specified with ARB:FNAM).

Example: INST OUT1
ARB:DATA 10,1,0.5,0
ARB:REP 10
ARB:FNAM "ARB03.CSV",INT
ARB:SAVE
Saves a predefined arbitrary data to a filename ARB03.CSV in the internal memory location.

Usage: Event

ARbitrary:SEquence:BEHavior:END <>

Sets or queries the arbitrary endpoint behavior, when arbitrary function is finished.

Parameters:

<> HOLD | OFF

<state> HOLD | OFF

OFF

If the arbitrary function is finished, the respective channel is deactivated automatically.

HOLD

If the arbitrary function is finished, the last arbitrary point of the user-defined arbitrary list is held.

*RST: OFF

Example: See [Example "Configuring an arbitrary sequence"](#) on page 131.

ARbitrary:SEquence:REPetitions <>

Sets or queries the number of repetitions of the arbitrary sequence

Parameters:

<repetition_rate> Range: 0 to 65535
The "0" indicates infinite repetition.

Example: See also [ARbitrary:REPetitions](#) on page 135.

ARbitrary:SEquence:TRANSfer

Transfers the defined arbitrary table to the selected channel.

Parameters:

<channel> 1 | 2 | 3 | 4

Example: See [Example "Configuring an arbitrary sequence"](#) on page 131.

Usage: Event

ARbitrary:TRIGgered[:STATe] <>

Sets or queries the trigger condition of the Arbitrary for the selected channel.

Parameters:

<condition> OFF | 1 | 2 | 3 | 4 | 5 | 6 | 7 | 8

OFF

There is no DIO pin that has a mode set to Arbitrary for the selected channel.

1 | 2 | 3 | 4 | 5 | 6 | 7 | 8

DIO pin/s are enabled with a mode set to Arbitrary for the selected channel.

When DIO pin is enabled with Arbitrary mode, arbitrary of the channel assigned to that pin will be enabled when the correct voltage is applied to the DIO pin.

7.7.2 EasyRamp

The `VOLTage:RAMP` subsystem contains the commands for configuring the EasyRamp function for the output channels.

<code>[SOURce:]VOLTage:RAMP[:STATe]</code>	137
<code>[SOURce:]VOLTage:RAMP:DURation</code>	137

[SOURce:]VOLTage:RAMP[:STATe] <arg0>

Sets or queries the state of ramp function for the previous selected channel.

Parameters:

<state>	0 1
0	EasyRamp function is deactivated.
1	EasyRamp function is activated.
*RST:	0

Example:

```
INST OUT1
VOLT:RAMP ON
VOLT:RAMP? -> 1
EasyRamp function of Ch1 is activated
```

[SOURce:]VOLTage:RAMP:DURation <New value for voltage>

Sets or queries the duration of the voltage ramp.

Parameters:

<duration>	numeric MIN MINimum MAX MAXimum DEF DEFault
numeric	Duration of the ramp function in seconds.
MIN	Minimum duration of the ramp function at 0.00 s.
MAX	Minimum duration of the ramp function at 10 s.
DEF	Default duration of the ramp function at 0.01 s.
Range:	0.01 to 10.00
*RST:	0.01

Default unit: s

Example: VOLT:RAMP:DUR 4
 VOLT:RAMP:DUR? -> 4
 Duration of the ramp function is set at 4 s.

7.7.3 Analog Input

The VOLTage:AINPut subsystem contains the commands for configuring the analog input.

[SOURce:]VOLTage:AINPut:INPut.....	138
[SOURce:]VOLTage:AINPut:TRIGgered[:STATe].....	138
[SOURce:]VOLTage:AINPut[:STATe].....	138

[SOURce:]VOLTage:AINPut:INPut <arg0>

Sets or queries the analog input mode.

Parameters:

<input> VOLT | CURR
VOLT
 Voltage mode.
CURR
 Current mode.

[SOURce:]VOLTage:AINPut:TRIGgered[:STATe] <arg0>

Sets or queries the trigger condition of the analog input for the selected channel.

Parameters:

<condition> OFF | 1 | 2 | 3 | 4 | 5 | 6 | 7 | 8
OFF
 There is no DIO pin that has a mode set to Analog In for the selected channel.
1 | 2 | 3 | 4 | 5 | 6 | 7 | 8
 DIO pin/s are enabled with a mode set to Analog In for the selected channel.
 When DIO pin is enabled with Analog In mode, analog input of the channel assigned to that pin will be enabled when the correct voltage is applied to the DIO pin.

[SOURce:]VOLTage:AINPut[:STATe] <arg0>

Enables or disables the analog input for the selected channel.

Parameters:

<arg0> 1 | 0

- 1**
Analog input for selected channel is enabled.
- 0**
Analog input for selected channel is disabled.

7.7.4 Adjustment

The CALibration subsystem contains the commands for analog input and channel adjustment.

CALibration:AINPut:CANCel.....	139
CALibration:AINPut:COUNT?.....	139
CALibration:AINPut:DATA.....	140
CALibration:AINPut:DATE?.....	140
CALibration:AINPut:END.....	140
CALibration:AINPut:FACTory:RESTore.....	140
CALibration:AINPut:SAVE.....	140
CALibration:AINPut:START.....	140
CALibration:AINPut:STATe?.....	140
CALibration:AINPut:UMAX.....	141
CALibration:AINPut:UMIN.....	141
CALibration:CANCel.....	141
CALibration:COUNT?.....	141
CALibration:CURREnt:DATA.....	141
CALibration:CURREnt:IMAX.....	142
CALibration:CURREnt:IMIN.....	142
CALibration:DATE?.....	142
CALibration:END.....	142
CALibration:FACTory:RESTore.....	142
CALibration:SAVE.....	142
CALibration:STATe?.....	142
CALibration:TEMPerature?.....	143
CALibration:USER.....	143
CALibration:VOLTage:DATA.....	143
CALibration:VOLTage:UMAX.....	143
CALibration:VOLTage:UMIN.....	143

CALibration:AINPut:CANCel

Cancels the analog input adjustment.

Usage: Event

CALibration:AINPut:COUNT?

Queries the number of counts performed for analog input adjustment .

Usage: Query only

CALibration:AINPut:DATA <arg0>

Sets the analog input adjustment data.

Parameters:

<data> Measured value from DMM.

CALibration:AINPut:DATE?

Returns the analog input adjustment date ("DD-MM-YY").

Usage: Query only

CALibration:AINPut:END

Ends the analog input adjustment.

Usage: Event

CALibration:AINPut:FACTory:REStore

Restores the analog input factory adjustment.

Usage: Event

CALibration:AINPut:SAVE

Saves the analog input adjustment.

Usage: Event

CALibration:AINPut:STARt <arg0>

Selects the analog input pin for adjustment.

Setting parameters:

<pin> Input pin for adjustment.

Range: 1 to 4

CALibration:AINPut:STATe?

Queries the analog input adjustment state.

State	Descriptions
0-15	0x0 - 0xE (0x0000 - 0x1111) bit3 bit2 bit1 bit0 bit0 - pin 1 of analog input bit1 - pin 2 of analog input bit2 - pin 3 of analog input bit3 - pin 4 of analog input e.g. 15 - All analog input pins are adjusted. e.g. 9 - Pin 1 and pin 4 are adjusted.
16	Idle
17	Busy
18	Waiting

Example:

```
CAL:AINP:STAT? -> 9
Pin 1 and pin 4 are adjusted successful.
```

Usage: Query only

CALibration:AINPut:UMAX

Value of high voltage applied to the analog input pin during adjustment.

Usage: Event

CALibration:AINPut:UMIN

Value of low voltage applied to the analog input pin during adjustment.

Usage: Event

CALibration:CANCel

Cancels the channel adjustment.

Usage: Event

CALibration:COUNt?

Queries the number of counts performed for channel adjustment.

Usage: Query only

CALibration:CURRent:DATA <arg0>

Set the current for channel adjustment.

Parameters:

<current> Measured value from DMM.

CALibration:CURRent:IMAX

Value of high current output during channel adjustment.

Usage: Event

CALibration:CURRent:IMIN

Value of low current output during channel adjustment.

Usage: Event

CALibration:DATE?

Returns the channel adjustment date.

Parameters:

<date> Date format "DD-MM-YY"

CALibration:END

Ends the channel adjustment.

Usage: Event

CALibration:FACTory:RESTore

Restores the factory channel adjustment.

Usage: Event

CALibration:SAVE

Saves the channel adjustment.

Usage: Event

CALibration:STATe?

Returns the current state of channel adjustment.

State	Descriptions
0	Idle
1	Busy
2	Waiting

State	Descriptions
12	Voltage adjustment completed
13	Current adjustment completed
16	Successful channel adjustment
17	Failed channel adjustment

Example: `CAL:STAT?` -> 12
Voltage adjustment is successful.

Usage: Query only

CALibration:TEMPerature?

Returns the temperature of selected channel.

Usage: Query only

CALibration:USER

Starts the channel adjustment process.

Usage: Event

CALibration:VOLTage:DATA <arg0>

Set the voltage for channel adjustment.

Parameters:

<voltage> Measured value from DMM.

CALibration:VOLTage:UMAX

Value of high voltage output during channel adjustment.

Usage: Event

CALibration:VOLTage:UMIN

Value of low voltage output during channel adjustment.

Usage: Event

7.8 Data and File Management Commands

The `DATA` and `HCOPY` subsystem contains commands for managing the files in the instrument and external USB stick.

The LOG subsystem contain the commands for managing the data logging of the instrument.

DATA:DATA?	144
DATA:DELeTe	144
DATA:LIST?	145
DATA:POINts?	145
HCOPy:DATA?	145
HCOPy:SIZE:X?	145
HCOPy:SIZE:Y?	145
LOG[:STATe]	146
LOG:COUNT	146
LOG:DURation	146
LOG:FNAME	147
LOG:INTerval	147
LOG:LOCation	148
LOG:MODE	148
LOG:STIMe	148
LOG:TRIGgered[:STATe]	149

DATA:DATA? <>

Returns the logging file data of the selected file.

If manual trigger mode (trigger via TRIG function) is used, the logging function has to be activated. Without activating the logging function in the manual trigger mode, the instrument is not able to save a logging file internally or on the USB stick.

Parameters:

<filepath> Filepath of the logging file data.

Example:

```
DATA:DATA?
"/int/logging/log-20201203T095013.965.csv" ->
#Device,NGP802
#Calibration Ch1,factory
Timestamp,U1[V],I1[A],P1[W]
09:50:14.078,2.0003,0.00007,0.00013
09:50:14.177,2.0003,0.00007,0.00014
09:50:14.278,2.0003,0.00007,0.00014
09:50:14.376,2.0003,0.00008,0.00016
09:50:14.477,2.0003,0.00008,0.00015
09:50:14.575,2.0003,0.00008,0.00017
```

Usage: Query only

DATA:DELeTe <>

Deletes the specified file from memory.

Setting parameters:

<filepath> Filepath of the file.

Example: DATA:DEL
 "/int/logging/log-20201203T095013.965.csv"
 Deletes internal logging file 'log-20201203T095013.965.csv'

Usage: Setting only

DATA:LIST?

Queries all files in internal memory ('/int/') and external memory ('/USB').

Example: DATA:LIST? -> "/USB1A/NGP/logging/
 log-20201203T101025.829.csv", "/int/arb/
 newWaveform.csv", "/int/logging/log-20201203T101129.818.csv"

Usage: Query only

DATA:POINTS? <>**DATA:POINTS?? <>**

Queries the number of measurements from the selected logging file.

If manual trigger mode (trigger via TRIG function) is used, the logging function has to be activated. Without activating the logging function in the manual trigger mode, the instrument is not able to save a logging file internally or on the USB stick.

Parameters:

<filepath> Filepath of the logging file data.

Example: DATA:POIN?
 "/USB1A/NGP/logging/log-20201203T101025.829.csv"
 -> 5
 Returns 5 log files counts from "/USB1A/NGP/logging/
 log-20201203T101025.829.csv".

Usage: Query only

HCOPY:DATA?

Returns the actual display content (screenshot). The DATA? query responses the screenshot data in binary format.

Usage: Query only

HCOPY:SIZE:X?

Returns the horizontal dimension of the screenshots.

Usage: Query only

HCOPY:SIZE:Y?

Returns the vertical dimension of the screenshots.

Usage: Query only

LOG[:STATe] <arg0>

Sets or queries the data logging state.

Parameters:

<state> OFF | ON | 0 | 1
ON | 1
 Data logging function is enabled.
OFF | 0
 Data logging function is disabled.
 *RST: OFF | 0

Example: LOG ON
 LOG? -> 1
 Data logging function is activated.

LOG:COUNT <Set new value>[, <Return min or max>]

LOG:COUNT? [<Return min or max>]

Sets or queries the number of measurement values to be captured.

Setting parameters:

<count> numeric_value | MIN | MINimum | MAX | MAXimum
numeric_value
 Number of measurement values to be captured is set in the range of 1 to 10000000.
MIN | MINimum
 Minimum number of measurement values to be captured is set at 1.
MAX | MAXimum
 Maximum number of measurement values to be captured is set at 10000000.

Parameters for setting and query:

<count> MIN | MINimum | MAX | MAXimum
 Returns the number of measurement values.

Example: LOG:COUNT MAX
 LOG:COUNT? MAX -> 10000000

LOG:DURATION <Set new value>[, <Return min or max>]

LOG:DURATION? [<Return min or max>]

Sets or queries the duration of the data logging.

Setting parameters:

<Set new value> numeric_values | MIN | MINimum | MAX | MAXimum

numeric_values

Duration of the data logging captured in the range of 0 s to $3.49 \cdot 10^5$ s.

MIN | MINimum

Minimum duration of the data logging captured at 0 s.

MAX | MAXimum

Maximum duration of the data logging captured at $3.49 \cdot 10^5$ s.

Default unit: s

Parameters for setting and query:

 MIN | MINimum | MAX | MAXimum
Returns the duration of the data logging.

Example:

```
LOG:DUR MAX
LOG:DUR? MAX -> 349000
```

LOG:FNAME <Set new value>

Sets or queries the filename and storage location for the data logging.

Setting parameters:

<Set new value>

Example:

```
LOG 0
LOG:FNAME? -> ""
LOG 1
LOG:FNAME? -> "/int/logging/log-20190318T1141853.407.csv"
Enables the data logging and queries the data log filename.
```

LOG:INTERVAL <Set new value>[, <Return min or max>]**LOG:INTERVAL?** [<Return min or max>]

Sets or queries the data logging measurement interval. The measurement interval describes the time between the recorded measurements.

Setting parameters:

<interval> numeric_value | MIN | MINimum | MAX | MAXimum

numeric_value

Measurement interval in the range of 0.1 s to 600 s.

MIN | MINimum

Minimum measurement interval is set at 0.1 s.

MAX | MAXimum

Maximum measurement interval is set at 600 s.

Default unit: s

Parameters for setting and query:

<Return min or max> MIN | MINimum | MAX | MAXimum
Returns the measurement interval.

Example: LOG:INT 10
LOG:INT? -> 10

LOG:LOCation [<>]

LOG:LOCation? [<>]

Sets or queries the logging location.

Parameters for setting and query:

<location? INT | EXT | DEF

INT

Internal location, i.e. "int/location/".

EXT

External location, i.e. "USB1A/INGP/ocation/".

DEF

Default location, i.e. "int/location/".

LOG:MODE <arg0>

LOG:MODE? <arg0>

Sets or queries the data logging mode.

Parameters for setting and query:

<mode> UNLimited | COUNT | DURation | SPAN

UNLimited

Infinite data capture.

COUNT

Number of measurement values to be captured.

DURation

Duration of the measurement values capture.

SPAN

Interval of the measurement values capture.

Example: LOG:MODE DUR
LOG:MODE? -> DUR

LOG:STIME <Year>, <Month>, <Day>, <Hour>, <Minute>, <Second>

Sets or queries the start time of the data logging function.

Parameters:

<Year> Sets the year for the data logging function.

Setting parameters:

<Month> Sets the month for the data logging function.

<Day> Sets the day for the data logging function.

<Hour> Sets the hour for the data logging function.

<Minute> Sets the minute for the data logging function.

<Second> Sets the second for the data logging function.

Example: LOG:STIM 2018,08,18,08,18,18
LOG:STIM? -> 2018,08,18,08,18,18

LOG:TRIGgered[:STATe] <arg0>

Sets or queries the trigger conditions for logging.

Parameters:

<condition> OFF | 1 | 2 | 3 | 4 | 5 | 6 | 7 | 8

OFF

There is no DIO pin that has a mode set to logging.

1 | 2 | 3 | 4 | 5 | 6 | 7 | 8

DIO pin/s are enabled with a mode set to logging.

When DIO pin is enabled with logging mode, logging of the channel assigned to that pin will be enabled when the correct voltage is applied to the DIO pin.

7.9 Status Reporting Commands

The status reporting system stores all information on the present operating state of the instrument, and on errors which have occurred. This information is stored in the status registers and in the error queue. The `STATUS:OPERation` and `STATUS:QUESTIONable` subsystems contains commands to control the status reporting structure of the instrument.

See [Chapter A.3.1, "Structure of a SCPI Status Register"](#), on page 160.

7.9.1 STATUS:OPERation Registers

The commands of the `STATUS:OPERation` subsystem control the status reporting structures of the `STATUS:OPERation` register.

The suffix at <Channel> selects the instrument channel. the range is <1...2>.

<code>STATUS:OPERation:INSTrument:CONDition?</code>	150
<code>STATUS:OPERation:INSTrument:ISUMmary<Channel>:CONDition?</code>	150
<code>STATUS:OPERation:INSTrument:ENABLE</code>	150
<code>STATUS:OPERation:INSTrument:ISUMmary<Channel>:ENABLE</code>	150
<code>STATUS:OPERation:INSTrument[:EVENT]?</code>	150
<code>STATUS:OPERation:INSTrument:ISUMmary<Channel>[:EVENT]?</code>	150
<code>STATUS:OPERation:INSTrument:NTRansition</code>	151
<code>STATUS:OPERation:INSTrument:ISUMmary<Channel>:NTRansition</code>	151
<code>STATUS:OPERation:INSTrument:PTRansition</code>	151
<code>STATUS:OPERation:INSTrument:ISUMmary<Channel>:PTRansition</code>	151

STATus:OPERation:INSTRument:CONDition?**STATus:OPERation:INSTRument:ISUMmary<Channel>:CONDition?**

Returns the contents of the CONDition part of the status register to check for operation instrument or measurement states. Reading the CONDition registers does not delete the contents.

Suffix:

<Channel> 1..n

Return values:

<Condition> Condition bits in decimal representation.

Range: 1 to 65535

Usage: Query only

STATus:OPERation:INSTRument:ENABle <arg0>**STATus:OPERation:INSTRument:ISUMmary<Channel>:ENABle <arg0>**

Controls or queries the ENABle part of the STATus:OPERation register. The ENABle defines which events in the EVENT part of the status register are forwarded to the OPERation summary bit (bit 7) of the status byte. The status byte can be used to create a service request.

Suffix:

<Channel> 1..n

Parameters:

<Enable> Range: 1 to 65535

Increment: 1

Example:

STATus:OPERation:INSTRument:ISUMmary1:ENABle?

Reads the enable register for the Standard Operation Register group

STATus:OPERation:INSTRument[:EVENT]?**STATus:OPERation:INSTRument:ISUMmary<Channel>[:EVENT]?**

Returns the contents of the EVENT part of the status register to check whether an event has occurred since the last reading. Reading an EVENT register deletes its contents.

Suffix:

<Channel> 1..n

Return values:

<Event> Range: 1 to 65535

Usage: Query only

STATus:OPERation:INSTRument:NTRansition <arg0>

STATus:OPERation:INSTRument:ISUMmary<Channel>:NTRansition <arg0>

Sets or queries the negative transition filter. Setting a bit in the negative transition filter shall cause a 1 to 0 transition in the corresponding bit of the associated condition register to cause a 1 to be written in the associated bit of the corresponding event register.

Suffix:

<Channel> 1..n

Parameters:

<NegativeTransition> Range: 1 to 65535

Example:

```
STATus:OPERation:INSTRument:ISUMmary1:
NTRansition?
Query for negative transition.
```

STATus:OPERation:INSTRument:PTRansition <arg0>

STATus:OPERation:INSTRument:ISUMmary<Channel>:PTRansition <arg0>

Sets or queries the positive transition filter. Setting a bit in the positive transition filter shall cause a 0 to 1 transition in the corresponding bit of the associated condition register to cause a 1 to be written in the associated bit of the corresponding event register.

Suffix:

<Channel> 1..n

Parameters:

<PositiveTransition> Range: 1 to 65535

Example:

```
STATus:OPERation:INSTRument:ISUMmary1:
PTRansition?
Query for positive transition.
```

7.9.2 STATus:QUEStionable Registers

The commands of the `STATus:QUEStionable` subsystem control the status reporting structures of the `STATus:QUEStionable` registers:

The suffix <n> at Channel selects the instrument. The range is <1...2>.

<code>STATus:QUEStionable:INSTRument:CONDition?</code>	152
<code>STATus:QUEStionable:INSTRument:ISUMmary<Channel>:CONDition?</code>	152
<code>STATus:QUEStionable:INSTRument:ENABLE</code>	152
<code>STATus:QUEStionable:INSTRument:ISUMmary<Channel>:ENABLE</code>	152
<code>STATus:QUEStionable:INSTRument[:EVENT]?</code>	152
<code>STATus:QUEStionable:INSTRument:ISUMmary<Channel>[:EVENT]?</code>	152
<code>STATus:QUEStionable:INSTRument:NTRansition</code>	153
<code>STATus:QUEStionable:INSTRument:ISUMmary<Channel>:NTRansition</code>	153
<code>STATus:QUEStionable:INSTRument:PTRansition</code>	153
<code>STATus:QUEStionable:INSTRument:ISUMmary<Channel>:PTRansition</code>	153

STATus:QUESTIONable:INSTrument:CONDition?**STATus:QUESTIONable:INSTrument:ISUMmary<Channel>:CONDition?**

Returns the contents of the CONDition part of the status register to check for questionable instrument or measurement states. Reading the CONDition registers does not delete the contents.

Suffix:

<Channel> 1..n

Return values:

<Condition> Condition bits in decimal representation

Range: 0 to 65535

Usage: Query only

STATus:QUESTIONable:INSTrument:ENABle <arg0>**STATus:QUESTIONable:INSTrument:ISUMmary<Channel>:ENABle <arg0>**

Sets or queries the enable mask that allows true conditions in the EVENT part to be reported in the summary bit.

If a bit in the ENABle part is 1, and the corresponding EVENT bit is true, a positive transition occurs in the summary bit. This transition is reported to the next higher level.

Suffix:

<Channel> 1..n

Parameters:

<Enable_Value> Bit mask in decimal representation

Range: 0 to 65535

Example:

```
STATus:QUESTIONable:INSTrument:ISUMmary1:
ENABle?
```

Queries the event register for the Standard QUESTIONable Register group.

STATus:QUESTIONable:INSTrument[:EVENT]?**STATus:QUESTIONable:INSTrument:ISUMmary<Channel>[:EVENT]?**

Returns the contents of the EVENT part of the status register to check whether an event has occurred since the last reading. Reading an EVENT register deletes its contents.

Suffix:

<Channel> 1..n

Return values:

<Event> Event bits in decimal representation

Range: 0 to 65535

Usage: Query only

STATus:QUESTIONable:INSTRument:NTRansition <arg0>

STATus:QUESTIONable:INSTRument:ISUMmary<Channel>:NTRansition <arg0>

Sets or queries the negative transition filter. Setting a bit in the negative transition filter shall cause a 1 to 0 transition in the corresponding bit of the associated condition register to cause a 1 to be written in the associated bit of the corresponding event register.

Suffix:

<Channel> 1..n

Parameters:

<NegativeTransition> Range: 1 to 65535

Example: STATus:QUESTIONable:INSTRument:ISUMmary1:
 NTRansition?
 Query for negative transition.

STATus:QUESTIONable:INSTRument:PTRansition <arg0>

STATus:QUESTIONable:INSTRument:ISUMmary<Channel>:PTRansition <arg0>

Sets or queries the positive transition filter. Setting a bit in the positive transition filter shall cause a 0 to 1 transition in the corresponding bit of the associated condition register to cause a 1 to be written in the associated bit of the corresponding event register.

Suffix:

<Channel> 1..n

Parameters:

<PositiveTransition> Range: 1 to 65535

Example: STATus:QUESTIONable:INSTRument:ISUMmary1:
 PTRansition?
 Query for positive transition.

Annex

A Additional Basics on Remote Control

A.1 Messages and Command Structure

A.1.1 Messages

Instrument messages are employed in the same way for all interfaces, if not indicated otherwise in the description.

- Structure and syntax of the instrument messages: [Chapter A.1.2, "SCPI Command Structure"](#), on page 155
- Detailed description of all messages: [Chapter 7, "Remote Control Commands"](#), on page 88

There are different types of instrument messages:

- Commands
- Instrument responses

Commands

Commands (program messages) are messages which the controller sends to the instrument. They operate the instrument functions and request information. The commands are subdivided according to two criteria:

Effects on the instrument:

- Setting commands cause instrument settings such as a reset of the instrument or setting the output voltage.
- Queries return data for remote control, e.g. for identification of the instrument or polling a parameter value. Queries are formed by appending a question mark to the command header.

Applied standards:

- The function and syntax of the common commands are precisely defined in standard IEEE 488.2. If implemented, they are used identically on all instruments. They refer to functions such as management of the standardized status registers, reset and self-test.
- Instrument control commands refer to functions depending on the features of the instrument such as voltage settings. Many of these commands have also been standardized by the SCPI committee. These commands are marked as "SCPI compliant" in the command reference chapters. Commands without this SCPI label

are device-specific, however, their syntax follows SCPI rules as permitted by the standard.

Instrument responses

Instrument responses (response messages and service requests) are messages which the instrument sends to the controller after a query. They can contain measurement results, instrument settings and information on the instrument status.

GPIB Interface Messages

Interface messages are transmitted to the instrument on the data lines with the attention line (ATN) being active (LOW). They are used for communication between the controller and the instrument and can only be sent by a PC which has the function of a GPIB bus controller. GPIB interface messages can be further subdivided into:

- **Universal commands** act on all instruments connected to the GPIB bus without previous addressing; universal commands are encoded in the range 10 through 1F hex. They affect all instruments connected to the bus and do not require addressing.
- **Addressed commands** only act on instruments previously addressed as listeners; addressed commands are encoded in the range 00 through 0F hex. They only affect instruments addressed as listeners.

A.1.2 SCPI Command Structure

SCPI commands consist of a so-called header and, usually, one or more parameters. The header and the parameters are separated by a whitespace. The headers can consist of several mnemonics (keywords). Queries are formed by appending a question mark directly to the header. The commands can be either device-specific or device-independent (common commands). Common and device-specific commands differ in their syntax.

Syntax for Common Commands

Common (= device-independent) commands consist of a header preceded by an asterisk (*) and possibly one or more parameters.

Table A-1: Examples of Common Commands

Command	Command Name	Description
*RST	Reset	Resets the instrument.
*ESE	Event Status Enable	Sets the bits of the event status enable registers.
*ESR?	Event Status Query	Queries the content of the event status register.
*IDN?	Identification Query	Queries the instrument identification string.

Syntax for Device-Specific Commands

For demonstration purposes only, assume the existence of the following commands for this section:

- MEASure:CURRent[:DC]?
- MEASure:VOLTage[:DC]?
- FUSE[:STATE] {ON | OFF | 0 | 1}
- FUSE[:STATE]?

Long and short form

The mnemonics feature a long form and a short form. The short form is marked by uppercase letters, the long form corresponds to the complete word. You can enter either the short form or the long form; other abbreviations are not permitted.

Example:

MEASure:CURRent? is equivalent to MEAS:CURR?



Case-insensitivity

Uppercase and lowercase notation only serves to distinguish the two forms in the manual, the instrument itself is case-insensitive.

Optional mnemonics

Some command systems permit inserting or omitting certain mnemonics in the header. These mnemonics are marked by square brackets. The instrument must recognize the long command to comply with the SCPI standard. Some commands are shortened by these optional mnemonics.

Example:

FUSE[:STATE] { ON }

FUSE:STAT ON is equivalent to FUSE ON

Special characters

Table A-2: Special characters

	<p>A vertical stroke in parameter definitions indicates alternative possibilities in the sense of "or". The effect of the command differs, depending on the used parameter.</p> <p>Example:</p> <ul style="list-style-type: none"> • FUSE:LINK {1 2 3} • FUSE:LINK 1 sets the fuse link CH1 for the selected channel FUSE:LINK 2 sets the fuse link of CH2 for the selected channel
[]	<p>Mnemonics in square brackets are optional and can be inserted into the header or be omitted.</p> <p>Example:</p> <ul style="list-style-type: none"> • FUSE[:STATe] { ON } • FUSE:STAT ON is equivalent to FUSE ON
{ }	<p>Parameters in curly brackets are optional and can be inserted once or several times, or be omitted.</p> <p>Example:</p> <ul style="list-style-type: none"> • VOLTage[:LEVel][:IMMediate][:AMPLitude] {<voltage> MIN MAX UP DOWN } <p>The following are valid commands:</p> <ul style="list-style-type: none"> - VOLT MAX - VOLT MIN VOLT 10

SCPI Parameters

Many commands are supplemented by a parameter or a list of parameters. The parameters must be separated from the header by a whitespace (ASCII code 0 to 9, 11 to 32 decimal, e.g. blank).

Allowed parameters are:

- Numeric values
- Special numeric values
- Boolean parameters
- Text
- Character strings
- Block data

The required parameters and the allowed value range are specified in the command description.

Numeric values

You can enter numeric values in the following form. Values exceeding the resolution of the instrument are rounded up or down.

Example:

VOLT 10V = VOLT 10

VOLT 100mV = VOLT 0.1

Special numeric values

The text listed below are interpreted as special numeric values. In the case of a query, the numeric value is provided.

- MIN / MAX

- **MINimum** and **MAXimum** denote the minimum and maximum value.

Example:

```
VOLT:PROT? MAX
```

Returns the maximum numeric value.

Boolean parameters

Boolean parameters represent two states:

- **On** (logically true), is represented by "On" or the numeric value "1"
- **Off** (logically false), is represented by "Off" or the numeric value "0"

The instrument returns the numerical value when queried.

Example:

```
OUTP:STAT ON
```

```
OUTP:STAT?
```

Response: 1

Overview of Syntax Elements

The following table provides an overview of the syntax elements:

Table A-3: Syntax Elements

:	A colon separates the mnemonics of a command.
,	A comma separates several parameters of a command.
?	A question mark forms a query.
*	An asterisk marks a common command.
"	Quotation marks introduce a string and terminate it.
	A whitespace (ASCII-Code 0 to 9, 11 to 32 decimal, e.g. blank) separates the header from the parameters.

Responses to Queries

You can query each setting command by adding a question mark. According to SCPI, the responses to queries are partly subject to stricter rules than in the standard IEEE 488.2.

- The requested parameter is transmitted without a header.

```
VOLTage:PROTEction:MODE?
```

 Response: "measured"
- Maximum values, minimum values and all other quantities that are requested via a special text parameter are returned as numeric values.

```
VOLT:PROT? MAX
```

 Response: 32.500
- Boolean values are returned as 0 (for Off) and 1 (for On).

```
OUTPut:STATe?
```

Response: 1

A.2 Command Sequence and Synchronization

A sequential command finishes the execution before the next command is starting. To make sure that commands are actually carried out in a certain order, each command must be sent in a separate command line.



As a rule, send commands and queries in different program messages.

A.2.1 Preventing Overlapping Execution

*Table A-4: Synchronization using *OPC, *OPC? and *WAI*

Command	Action	Programming the controller
*OPC	Sets the Operation Complete bit in the ESR after all previous commands have been executed.	<ul style="list-style-type: none"> Setting bit 0 in the ESE Setting bit 5 in the SRE Waiting for service request (SRQ)
*OPC?	Stops command processing until 1 is returned. It occurs after the Operation Complete bit has been set in the ESR. This bit indicates that the previous setting has been completed.	Sending *OPC? directly after the command whose processing should be terminated before other commands can be executed.
*WAI	Stops further command processing until all commands have been executed before *WAI.	Sending *WAI directly after the command whose processing should be terminated before other commands are executed

To prevent an overlapping execution of commands the commands *OPC, *OPC? or *WAI can be used. All three commands cause a certain action only to be carried out after the hardware has been set. The controller can be forced to wait for the corresponding action.



The R&S NGP800 series does not support parallel processing of remote commands. If OPC? returns a "1", the device is able to process new commands.

A.3 Status Reporting System

The status reporting system stores all information on the current operating state of the instrument and errors which have occurred. This information is stored in the status reg-

isters and in the error queue. You can query both via RS-232, USB, GPIB or LAN interface (STATus... commands).

A.3.1 Structure of a SCPI Status Register

Each standard SCPI register consists of 2 or 3 parts (Event, Condition and Enable register). Each part has a width of 16 bits and has different functions. The individual bits are independent of each other, i.e. each hardware status is assigned a bit number which is valid for all 2 or 3 parts. Bit 15 (the most significant bit) is set to zero for all parts. Thus the controller can process contents of the register parts as positive integers.

STATus:QUEStionable:INSTRument:ISUMmary1 exists as often as device channels are available (e.g. NGP802 / NGP822 = 2 channels = 2 status register). Accordingly, the description text of the channel information changes in [Figure A-1](#) (e.g. instrument 1 = channel 1, instrument 2 = channel 2 etc.).



Depending on the value of the read register, you can draw conclusions on the current status of the device. For example, when the unit operates in constant voltage, the result of the returned ISUM register is a decimal "2" which corresponds the binary value of "0000000000000010".

Any part of a status register system can be read by query commands. A decimal value is returned and represents the bit pattern of the requested register. Each SCPI register is 16 bits wide and has various functions. The individual bits are independent, i.e. each hardware status is assigned to a bit number.

Bits 9 to 12 are still "free" resp. unused (always return a "0"). Certain areas of the registers are not used. The SCPI standard defines only the "basic functions". Some devices offer an advanced functionality.

Each channel of the power supply is considered as separate "instrument" (SCPI standard definition). Therefore, e.g. the register

STATus:QUEStionable:INSTRument:ISUMary of the NGP802 / NGP822 / NGP804 / NGP824 / NGP814 is also present four times (Isummary1 - Isummary4).

Description of the status register parts

The SCPI standard provides two different status registers:

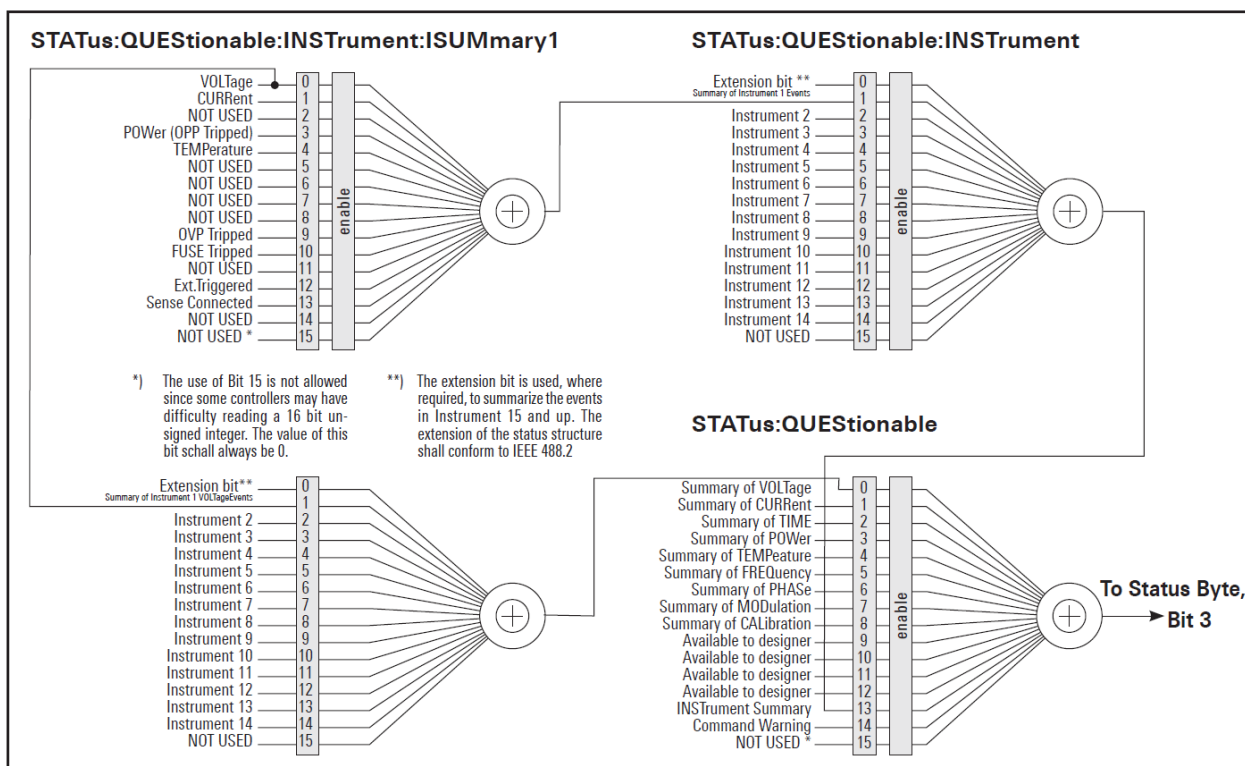

Figure A-1: Structure of the status QUESTIONable register

CONDition

- The CONDition register queries the actual state of the instrument. If you want to query the constant voltage or current mode, you have to use the CONDition register.



The CONDition register delivers a "1" (first bit set) in constant current mode (CC) and a "2" (second bit set) in constant voltage mode (CV).

If the correct channel is selected and the red LED of the channel button lights up (CC mode), the query of the CONDition register must deliver a "1".

Example:

```
STAT:QUES:ISUM1:COND?
```

EVENT

- The EVENT status register is set (1) until it is queried. After reading (query), the EVENT status register is set to zero.



The description of registers is only used for general explanation. Due to the complexity, we recommend the general accessible SCPI standard document for more detailed information.

For further description of the status register, see [Chapter 7.9, "Status Reporting Commands"](#), on page 149.

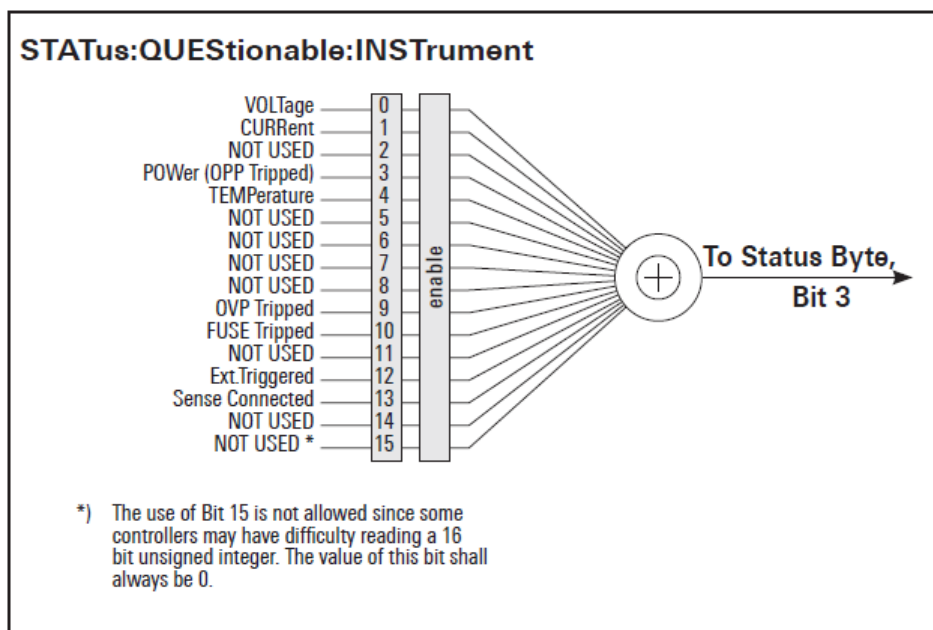

Event Status Register (ESR) and Event Status Enable Register (ESE)

The ESR is defined in IEEE 488.2. It can be compared with the `EVENT` part of an SCPI register. The event status register can be read out using the command `*ESR?`. The ESE corresponds to the `ENABLE` part of an SCPI register. If a bit is set in the ESE and the associated bit in the ESR changes from 0 to 1, the ESB bit in the STB is set. The ESE register can be set using the command `*ESE` and read using the command `*ESE?`.

STATUS:OPERation Register

In the `CONDITION` part, this register contains information on which actions the instrument is being executing or, in the `EVENT` part, information on which actions the instrument has executed since the last reading. It can be read using the commands `STATUS:OPERation:CONDition?` or `STATUS:OPERation[:EVENT]?`.

Bit No.	Meaning
0	CALibrating This bit is set as long as the instrument is performing a calibration.
1 to 9	Not used

Bit No.	Meaning
10	Logging This bit is set as long as "Logging" is enabled
11	Not used
12	FastLog This bit is set once "FastLog" data is available
13 to 14	Not used
15	This bit is always 0

STATus:QUESTionable Register

This register contains information about different states which can occur. It can be read using the commands `STATus:QUESTionable:CONDition?` and `STATus:QUESTionable[:EVENT]?`. See [Figure A-1](#).

Table A-5: Bits of the STATus:QUESTionable register

Bit No.	Meaning
0	Voltage This bit is set while the instrument is in constant current mode (CC). The voltage is regulated and the current is constant.
1	Current This bit is set while the instrument is in constant voltage mode (CV). The current is variable and the voltage is constant.
2 to 3	Not used
4	Temperature overrange This bit is set if an over temperature occurs.
5 to 8	Not used
9	OVP Tripped This bit is set if the over voltage protection has tripped.
10	Fuse Tripped This bit is set if the fuse protection has tripped.
11 to 15	Not used

Query of an instrument status

Each part of any status register can be read using queries.

There are two types of commands:

- The common commands `*ESR?`, `*IDN?`, `*STB?` query the higher-level registers.
- The commands of the `STATus` system query the SCPI registers (`STATus:QUESTionable`)

The returned value is always a decimal number that represents the bit pattern of the queried register. This number is evaluated by the controller program.

Decimal representation of a bit pattern (binary weights)

The STB and ESR registers contain 8 bits, the status registers 16 bits. The contents of a status register are specified and transferred as a single decimal number. To make this possible, each bit is assigned a weighted value. The decimal number is calculated as the sum of the weighted values of all bits in the register that are set to 1.

Bits	0	1	2	3	4	5	6	7	...
Weight	1	2	4	8	16	32	64	128	...

Figure A-2: Decimal representation of a bit pattern

Error Queue

Each error state in the instrument leads to an entry in the error queue. The entries of the error queue are detailed plain text error messages. You can look them up in the error log or via remote control using `SYSTem:ERRor[:NEXT]?`. Each call of `SYSTem:ERRor[:NEXT]?` provides one entry from the error queue. If no error messages are stored, the instrument responds with 0, "No error".

List of Commands

[SOURce:]ALIMit[:STATe].....	104
[SOURce:]CURRent[:LEVel][:IMMediate]:ALIMit:LOWer.....	105
[SOURce:]CURRent[:LEVel][:IMMediate]:ALIMit[:UPPer].....	105
[SOURce:]CURRent[:LEVel][:IMMediate]:STEP[:INCRement].....	112
[SOURce:]CURRent[:LEVel][:IMMediate][:AMPLitude].....	111
[SOURce:]POWer:PROTection:CLEar.....	125
[SOURce:]POWer:PROTection:LEVel.....	125
[SOURce:]POWer:PROTection:TRIPped?.....	125
[SOURce:]POWer:PROTection[:STATe].....	124
[SOURce:]PROTection:CLEar.....	126
[SOURce:]VOLTag:e:AINPut:INPut.....	138
[SOURce:]VOLTag:e:AINPut:TRIGgered[:STATe].....	138
[SOURce:]VOLTag:e:AINPut[:STATe].....	138
[SOURce:]VOLTag:e:PROTection:CLEar.....	122
[SOURce:]VOLTag:e:PROTection:LEVel.....	122
[SOURce:]VOLTag:e:PROTection:TRIPped?.....	123
[SOURce:]VOLTag:e:PROTection[:STATe].....	122
[SOURce:]VOLTag:e:RAMP:DURation.....	137
[SOURce:]VOLTag:e:RAMP[:STATe].....	137
[SOURce:]VOLTag:e:SENSe[:SOURce].....	106
[SOURce:]VOLTag:e[:LEVel][:IMMediate]:ALIMit:LOWer.....	104
[SOURce:]VOLTag:e[:LEVel][:IMMediate]:ALIMit[:UPPer].....	104
[SOURce:]VOLTag:e[:LEVel][:IMMediate]:STEP[:INCRement].....	108
[SOURce:]VOLTag:e[:LEVel][:IMMediate][:AMPLitude].....	108
*CLS.....	88
*ESE.....	88
*ESR?.....	89
*IDN?.....	89
*OPC.....	89
*OPT?.....	89
*RCL.....	90
*RST.....	89
*SAV.....	90
*SRE.....	89
*STB?.....	90
*TST?.....	90
*WAI.....	90
APPLY.....	112
ARBitrary:BLOCK.....	132
ARBitrary:BLOCK:CLEar.....	132
ARBitrary:BLOCK:DATA.....	132
ARBitrary:BLOCK:ENDPoint?.....	132
ARBitrary:BLOCK:FNAME.....	133
ARBitrary:BLOCK:REPetitions.....	133
ARBitrary:CLEar.....	134
ARBitrary:DATA.....	134
ARBitrary:FNAME.....	134

ARbitrary:LOAD.....	135
ARbitrary:REPetitions.....	135
ARbitrary:SAVE.....	135
ARbitrary:SEquence:BEHavior:END.....	136
ARbitrary:SEquence:ENDPoint?.....	134
ARbitrary:SEquence:REPetitions.....	136
ARbitrary:SEquence:TRANsfer.....	136
ARbitrary:TRIGgered[:STATe].....	136
ARbitrary[:STATe].....	133
CALibration:AINPut:CANcEl.....	139
CALibration:AINPut:COUNT?.....	139
CALibration:AINPut:DATA.....	140
CALibration:AINPut:DATE?.....	140
CALibration:AINPut:END.....	140
CALibration:AINPut:FACTory:REStore.....	140
CALibration:AINPut:SAVE.....	140
CALibration:AINPut:START.....	140
CALibration:AINPut:STATe?.....	140
CALibration:AINPut:UMAX.....	141
CALibration:AINPut:UMIN.....	141
CALibration:CANcEl.....	141
CALibration:COUNT?.....	141
CALibration:CURRent:DATA.....	141
CALibration:CURRent:IMAX.....	142
CALibration:CURRent:IMIN.....	142
CALibration:DATE?.....	142
CALibration:END.....	142
CALibration:FACTory:REStore.....	142
CALibration:SAVE.....	142
CALibration:STATe?.....	142
CALibration:TEMPerature?.....	143
CALibration:USER.....	143
CALibration:VOLTagE:DATA.....	143
CALibration:VOLTagE:UMAX.....	143
CALibration:VOLTagE:UMIN.....	143
DATA:DATA?.....	144
DATA:DELeTe.....	144
DATA:LIST?.....	145
DATA:POINts?.....	145
DISPlay:BRIGhtness.....	97
DISPlay[:WINDow]:TEXT:CLear.....	97
DISPlay[:WINDow]:TEXT[:DATA].....	97
FUSE:DELay:INITial.....	118
FUSE:DELay[:BLOWing].....	119
FUSE:LINK.....	119
FUSE:TRIPped:CLear.....	118
FUSE:TRIPped?.....	119
FUSE:UNLink.....	119
FUSE[:STATe].....	120
HCOPY:DATA?.....	145

HCOPY:SIZE:X?.....	145
HCOPY:SIZE:Y?.....	145
INSTrument:NSElect.....	102
INSTrument[:SElect].....	102
LOG:COUNt.....	146
LOG:DURation.....	146
LOG:FNAME.....	147
LOG:INTerval.....	147
LOG:LOCation.....	148
LOG:MODE.....	148
LOG:STIME.....	148
LOG:TRIGgered[:STATe].....	149
LOG[:STATe].....	146
MEASure[:SCALar]:CURRent[:DC]:AVG?.....	128
MEASure[:SCALar]:CURRent[:DC]:MAX?.....	128
MEASure[:SCALar]:CURRent[:DC]:MIN?.....	128
MEASure[:SCALar]:CURRent[:DC]:STATistic?.....	128
MEASure[:SCALar]:CURRent[:DC]?.....	128
MEASure[:SCALar]:ENERgy?.....	127
MEASure[:SCALar]:POWer:AVG?.....	129
MEASure[:SCALar]:POWer:MAX?.....	129
MEASure[:SCALar]:POWer:MIN?.....	129
MEASure[:SCALar]:POWer:STATistic?.....	129
MEASure[:SCALar]:POWer?.....	128
MEASure[:SCALar]:STATistic:COUNt?.....	127
MEASure[:SCALar]:STATistic:RESet.....	128
MEASure[:SCALar][:VOLTage][:DC]:AVG?.....	129
MEASure[:SCALar][:VOLTage][:DC]:MAX?.....	129
MEASure[:SCALar][:VOLTage][:DC]:MIN?.....	129
MEASure[:SCALar][:VOLTage][:DC]:STATistic?.....	130
MEASure[:SCALar][:VOLTage][:DC]?.....	129
OUTPut:DELay:DURation.....	115
OUTPut:DELay[:STATe].....	115
OUTPut:GENeral[:STATe].....	114
OUTPut:SElect.....	116
OUTPut[:STATe].....	115
STATus:OPERation:INSTrument:CONDition?.....	150
STATus:OPERation:INSTrument:ENABle.....	150
STATus:OPERation:INSTrument:ISUMmary<Channel>:CONDition?.....	150
STATus:OPERation:INSTrument:ISUMmary<Channel>:ENABle.....	150
STATus:OPERation:INSTrument:ISUMmary<Channel>:NTRansition.....	151
STATus:OPERation:INSTrument:ISUMmary<Channel>:PTRansition.....	151
STATus:OPERation:INSTrument:ISUMmary<Channel>[:EVENT]?.....	150
STATus:OPERation:INSTrument:NTRansition.....	151
STATus:OPERation:INSTrument:PTRansition.....	151
STATus:OPERation:INSTrument[:EVENT]?.....	150
STATus:QUEStionable:INSTrument:CONDition?.....	152
STATus:QUEStionable:INSTrument:ENABle.....	152
STATus:QUEStionable:INSTrument:ISUMmary<Channel>:CONDition?.....	152
STATus:QUEStionable:INSTrument:ISUMmary<Channel>:ENABle.....	152

STATus:QUEStionable:INSTrument:ISUMmary<Channel>:NTRansition.....	153
STATus:QUEStionable:INSTrument:ISUMmary<Channel>:PTRansition.....	153
STATus:QUEStionable:INSTrument:ISUMmary<Channel>[:EVENT]?	152
STATus:QUEStionable:INSTrument:NTRansition.....	153
STATus:QUEStionable:INSTrument:PTRansition.....	153
STATus:QUEStionable:INSTrument[:EVENT]?	152
SYSTem:BEEPer:CURRent:STATe.....	91
SYSTem:BEEPer:PROTection:STATe.....	92
SYSTem:BEEPer:PROTection[:IMMEDIATE].....	92
SYSTem:BEEPer:WARning:STATe.....	92
SYSTem:BEEPer:WARning[:IMMEDIATE].....	92
SYSTem:COMMunicate:SOCKeT:APPLY.....	92
SYSTem:COMMunicate:SOCKeT:DHCP.....	93
SYSTem:COMMunicate:SOCKeT:GATeway.....	93
SYSTem:COMMunicate:SOCKeT:IPAdDress.....	93
SYSTem:COMMunicate:SOCKeT:MASK.....	93
SYSTem:COMMunicate:WLAN:CONNection[:STATe].....	93
SYSTem:COMMunicate:WLAN:IPAdDress.....	94
SYSTem:COMMunicate:WLAN:PASSword.....	94
SYSTem:COMMunicate:WLAN:SSID.....	94
SYSTem:COMMunicate:WLAN[:STATe].....	94
SYSTem:DATE.....	95
SYSTem:INTerface:GPIB?.....	95
SYSTem:INTerface?.....	95
SYSTem:KEY:BRIGhtness.....	95
SYSTem:LOCal.....	95
SYSTem:REMote.....	96
SYSTem:RWLock.....	96
SYSTem:TIME.....	96
SYSTem:TOUCH[:STATe].....	96
SYSTem:UPTime?.....	96
TRACking[:ENABle]:CH<CHANNEL>.....	126
TRACking[:ENABle]:GENeral.....	126
TRACking[:ENABle]:SELect:CH<CHANNEL>.....	126
TRIGger:CHANnel:DIO<IO>.....	97
TRIGger:CONDition:DIO<IO>.....	98
TRIGger:DIRectioN:DIO<IO>.....	99
TRIGger:LOGic:DIO<IO>.....	100
TRIGger[:ENABle]:DIO<IO>.....	100
TRIGger[:ENABle]:GENeral.....	100
TRIGger[:ENABle]:SELect:DIO<IO>.....	101

Index

A

Activate channel output	44
Adjustment	81
Analog in adjustment	82
Channel adjustment	84
Advanced features	
EasyRamp	57
QuickArb	57
Advanced operating commands	
Adjustment	139
Analog input	138
EasyRamp	137
QuickArb	130
Alert beep	78
Analog input	48

C

Calibration certificate	7
Channel adjustment	
Current adjustment	84
Voltage adjustment	84
Channel display area	
Operating mode	32
Clear status	
Remote	88
Command sequence	
Remote	90
Command sequence and synchronization	159
Configuration commands	
Channel selection	101
Combined setting of voltage and current settings	112
Current setting	109
OCP setting	116
OPP setting	123
Output setting	113
OVP setting	120
Reset protection tripped state	126
Safety limit setting	103
Tracking setting	126
Voltage setting	106
Controls	20
CSV settings	65

D

Data logging	63
CSV settings	63
Date	79
Default values	
Remote	89
Delivery package contents	18
Device/Channel menu window	37
Digital trigger I/O	54
Display brightness	77
Display overview	29
Channel display area	32
Status bar information	29
Documentation overview	7

E

EasyRamp	60
----------------	----

Event status enable register (ESE)	
Remote	88
Event status register (ESR)	
Remote	89

F

Factory default settings	67
File manager	
Copy	66
Delete	66
Front panel	
Back key	21
Chassis ground terminal	21
Display	20
Menu control keys	22
Output and channel keys	21
Output terminals	21
Power key	21
Rotary knob	21
USB connector	21
Front panel keys	37
Menu controls	37
Navigation controls	40
Output and channel controls	41
Settings key	37

G

General instrument settings	76
Appearance settings	77
Data and time	79
Device information	79
Licenses management	76
Sound settings	78
Update device	80
Getting Started	7

I

Identification	
Remote	89
Important notes	
Ambient conditions	11
Limits	13
Mains voltage	12
Measurement categories	12
Symbols	11
Instrument tour	20
Overview controls	20
Switching NGP on off	24
Intended operation	16
Interfaces	69

K

Key brightness	77
----------------------	----

M

Maintenance	
Cleaning	27
Internal battery replacement	28

Menu	
Channel menu	39
Device menu	37
Menu controls	37
Home key	37
Settings key	37
User key	40
Message and command structure	
Messages	154
SCPI command structure	155
Mode	
Operation modes	42
N	
Navigation controls	40
Back key	40
Rotary knob	40
Network	
GPIB	75
LAN	71
USB	74
Wireless LAN	73
Network connection	70
O	
Open source acknowledgment (OSA)	7
Operation complete	
Remote	89
Operation modes	
Constant current (CC)	42
Constant voltage (CV)	42
Options	
Identification (remote)	89
Output	45
Delay	45
Output delay	45
Remote sense	47
Output and channel controls	41
Output auto-ranging	41
Over current protection	50
Over power protection	51
Over voltage protection	50
Overview controls	
Front panel	20
Rear panel	22
P	
Protection	
Fuse linking	49
Over current protection	49
Over power protection	49
Over voltage protection	49
Safety limits	49
Putting into operation	14
Intended operation	16
Safety	15
Unpacking and checking the instrument	17
Q	
QuickArb	57
R	
Rear panel	
AC inlet with integrated 2-pole rocker switch	22
Analog input connector	23
Channel connectors	23
Digital I/O connector	23
Ethernet connector	23
Ground terminal	23
IEEE-488 (GPIB) interface	23
Kensington security slot	23
USB connectors	23
Recall	67
Release notes	7
Remote command	
Status reporting commands	149
Remote control commands	88
Advanced operating commands	130
Common setting commands	88
Configuration commands	101
Data and file management commands	143
Display commands	96
Measurement commands	127
Remote sense commands	105
Status reporting commands	149
System settings commands	91
Trigger commands	97
Reset values	
Remote	89
S	
Safety	15
Safety instructions	7
Safety limits	52
Save	67
Screenshot	62
Selecting channels	43
Self-test	
Remote	90
Service request enable register (SRE)	
Remote	89
Set voltage and current	43
Setting up the instrument	18
Bench operation	19
Rack mounting	19
Status bar information	
Channel status bar	30
Device status bar	30
Status byte	
Remote	88, 90
Status reporting system	159
Structure of a SCPI status register	160
Switching off the instrument	24
Switching on the instrument	24
T	
Time	79
Tracking function	53
Trying out the instrument	
Activating the channels output	26
Selecting the channels	24
Setting the output voltage and current limit	24

U

Unpacking and checking the instrument	17
User button key	61
User manual	7
Using the touchscreen	33
Accessing functionality using shortcuts	35
Accessing functionality using the settings button	34
Expand/Collapse button	35
Input data	36
Using gestures	33

W

Wait	
Remote	90
Welcome to R&S NGP800	9