

INSTRUCTION MANUAL

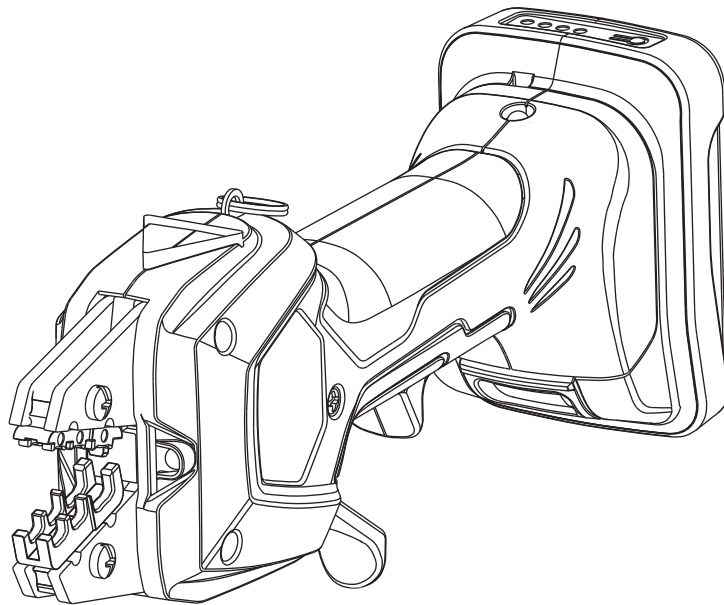

GREENLEE[®]
A Textron Company

Serial Number



EK50ML **Battery-powered** **Crimping Tool**



Read and understand all of the instructions and safety information in this manual before operating or servicing this tool.

Register this product at www.greenlee.com

Table of Contents

Description	2
Safety	2
Purpose of this Manual	2
Important Safety Information	3-4
Identification	5
Specifications	5
Battery Charger	6
Operation	7-8
Maintenance	9
Troubleshooting	10
Die Holders	11
CrimpALL® Interchangeable Die Sets	11-13
Illustration	14
Parts List	15-16

Description

The EK50ML Battery-powered Crimping Tool is a hand-held, self-contained crimping tool intended to crimp cable using Greenlee's Kwik Cycle® 9 and CrimpALL® die sets as well as some competitors' die sets.

U.S. patent pending.

Safety

Safety is essential in the use and maintenance of Greenlee tools and equipment. This manual and any markings on the tool provide information for avoiding hazards and unsafe practices related to the use of this tool. Observe all of the safety information provided.

Purpose of this Manual

This manual is intended to familiarize all personnel with the safe operation and maintenance procedures for the following Greenlee tool:

EK50ML Battery-powered Crimping Tool

Keep this manual available to all personnel.

Replacement manuals are available upon request at no charge at www.greenlee.com.



Do not discard this product or throw away!

For recycling information, go to www.greenlee.com.

All specifications are nominal and may change as design improvements occur. Greenlee Textron Inc. shall not be liable for damages resulting from misapplication or misuse of its products.

CrimpALL and Kwik Cycle are registered trademarks of Textron Innovations Inc.

Teflon is a registered trademark of Dupont.

KEEP THIS MANUAL

IMPORTANT SAFETY INFORMATION



SAFETY ALERT SYMBOL

This symbol is used to call your attention to hazards or unsafe practices which could result in an injury or property damage. The signal word, defined below, indicates the severity of the hazard. The message after the signal word provides information for preventing or avoiding the hazard.

⚠ DANGER

Immediate hazards which, if not avoided, **WILL** result in severe injury or death.

⚠ WARNING

Hazards which, if not avoided, **COULD** result in severe injury or death.

⚠ CAUTION

Hazards or unsafe practices which, if not avoided, **MAY** result in injury or property damage.

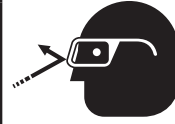

⚠ WARNING

Wear eye protection when operating or servicing this tool.

Failure to wear eye protection could result in serious eye injury from flying debris or hydraulic oil.



⚠ WARNING

Do not use solvents or flammable liquids to clean the tool body. Solvents or flammable liquids could ignite and cause serious injury or property damage.

⚠ WARNING

An incomplete crimp can cause a fire.

Use proper die, connector, and cable combinations. Improper combinations can result in an incomplete crimp.

Failure to observe this warning could result in severe injury or death.

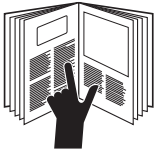

⚠ WARNING

Read and understand all of the instructions and safety information in this manual before operating or servicing this tool.

Failure to observe this warning could result in severe injury or death.



⚠ WARNING

Pinch points:

- Remove battery before changing dies, adapters, or jaws.
- Keep hands away from the crimping tool head when crimping.

Failure to observe these warnings could result in severe injury or death.



⚠ WARNING

Electric shock hazard:

This tool is not insulated. When using this unit on or near energized electrical lines, use proper personal protective equipment.

Failure to observe this warning could result in severe injury or death.

⚠ WARNING

Do not dispose of batteries in a fire. They will vent fumes and may explode.

Failure to observe this warning could result in severe injury from harmful fumes or burns from flying debris.

IMPORTANT SAFETY INFORMATION

⚠ WARNING

Inspect tool and dies before use. Replace any worn or damaged parts. A damaged or improperly assembled tool can break and strike nearby personnel.

Failure to observe this warning could result in severe injury or death.

⚠ CAUTION

- Allow approximately 3 to 5 minutes of time to cool down as tool automatically switches off when it gets too hot.
- Do not secure this tool in a vise. This tool is designed for hand-held operation.
- This tool may be used in damp or wet environments; however, air-drying is recommended before use if the tool becomes soaked. Damage may result when the tool is operated prior to thorough drying when electrical components are soaked.
- Use this tool for the manufacturer's intended purpose only.

Failure to observe these precautions may result in injury or property damage.

⚠ CAUTION

Do not allow anything to contact the battery terminals.

- Do not immerse the batteries in liquid. Liquid may create a short circuit and damage the battery. If batteries are immersed, contact your service center for proper handling.
- Do not place the battery into a pocket, tool pouch, or tool box with conductive objects. Conductive objects may create a short circuit and damage the battery.
- Do not place a battery on moist ground or grass. Moisture may create a short circuit and damage the battery.

Failure to observe these precautions may result in injury or property damage.

⚠ CAUTION

- Do not store the battery at more than 122 °F (50 °C) or less than -4 °F (-20 °C). Damage to the battery can result.
- Do not use another manufacturer's charger. Other manufacturers' chargers may overcharge and damage the battery.
- Do not attempt to open the battery. It contains no user-serviceable parts.

Failure to observe these precautions may result in injury or property damage.

⚠ CAUTION

Do not perform any service or maintenance other than as described in this manual. Injury or damage to the tool may result.

Failure to observe this precaution may result in injury and property damage.

Note: Keep all decals clean and legible, and replace when necessary.

Identification

- 1. Crimping Dies
- 2. LED Work Light (white)
- 3. Crimping Head
- 4. LED Indicator (red)
- 5. Battery Cartridge
- 6. Battery Lock
- 7. Trigger

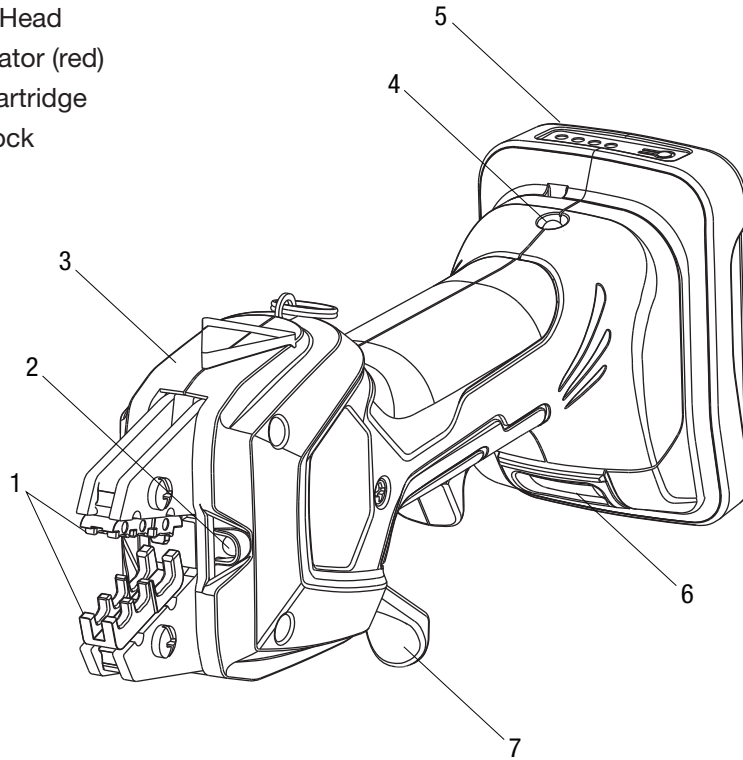

Specifications

Crimping Tool

Length (with battery).....	9.93" (252.22 mm)
Width	2.5" (63.5 mm)
Depth.....	3.6" (91.44 mm)
Weight.....	2.18 lb (0.98 kg)
Crimping Force.....	1.53 tons (15 kN)
Recommended Operating Temperature Range.....	14 °F to 104 °F (-10 °C to 40 °C)

Battery

Charging Time	40 min
---------------------	--------

52068453	Battery, 10.8V 1.5 Ah li-ion (16.2 Wh)
52068454	Charger, 10.8V li-ion batteries, 110V
52068584	Charger, 10.8V li-ion batteries, 230V

Battery and Charger

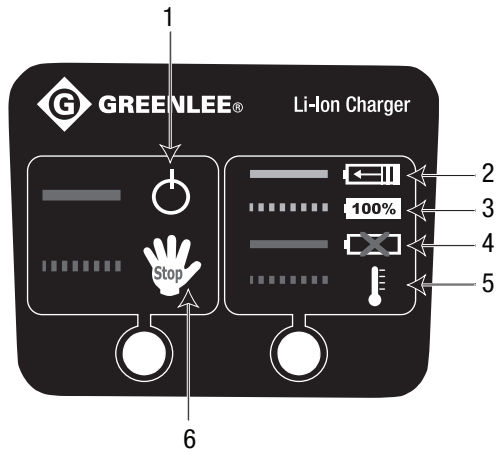

1. Charger is plugged into socket.
2. Battery is charging.
3. Battery is fully charged.
4. Battery is defective.
5. Battery is too hot or too cold.
6. Charger is defective.

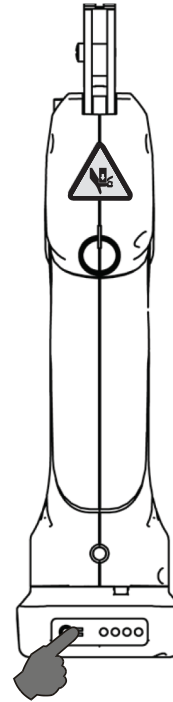

% Charge Remaining

100%	
75%	
50%	
25%	
0%	

CAUTION

Remove battery only after unplugging charger from socket.

Failure to observe this precaution may result in injury and property damage.

Operation

⚠ WARNING

Inspect tool and dies before use. Replace any worn or damaged parts. A damaged or improperly assembled tool can break and strike nearby personnel.

Failure to observe this warning could result in severe injury or death.

⚠ WARNING



Electric shock hazard:

This tool is not insulated. When using this unit on or near energized electrical lines, use proper personal protective equipment.

Failure to observe this warning could result in severe injury or death.

⚠ WARNING

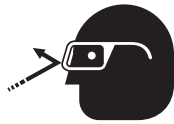

Wear eye protection when operating or servicing this tool.

Failure to wear eye protection could result in serious eye injury from flying debris or hydraulic oil.

⚠ WARNING



Pinch points:

- Remove battery before changing dies, adapters, or jaws.
- Keep hands away from the crimping tool head when crimping.

Failure to observe these warnings could result in severe injury or death.

⚠ CAUTION

- Allow approximately 3 to 5 minutes of time to cool down as tool automatically switches off when it gets too hot.
- Do not secure this tool in a vise. This tool is designed for hand-held operation.
- Use this tool for the manufacturer's intended purpose only.

Failure to observe these precautions may result in injury or property damage.

Charging the Battery







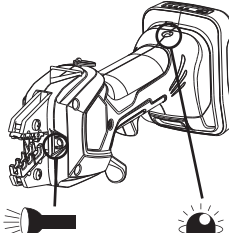

Read the instructions supplied with the battery charger.

LED Work Light (white)

This LED automatically turns on when the trigger is pulled. It remains on for 10 seconds after the trigger is released.

LED Indicator (red)

This tool is equipped with a special circuit board incorporating several important features to inform the user about the current status of the unit. The LED signals in the following cases:

		When	What it means
	2 x	After inserting the battery	Battery is inserted in tool
	20 sec	After working cycle	Low battery
	20 sec/2 Hz		Contact Greenlee service
	20 sec/5 Hz		Tool has become too hot
	1 x	After interruption	Error – manual interruption of crimp cycle prior to completion
	1 x		
	3 x	After working cycle	Error – automatic opening of tool due to exceeding crimp force
	3 x		

Operation (cont'd)

Installing Dies

1. Select the proper dies for the intended crimp.
2. Slide the die into the crimping head and secure with screw.
3. Properly position the second die. Repeat Step 2.

Preparing Cable

Follow the lug manufacturer's instructions for appropriate cable strip length.

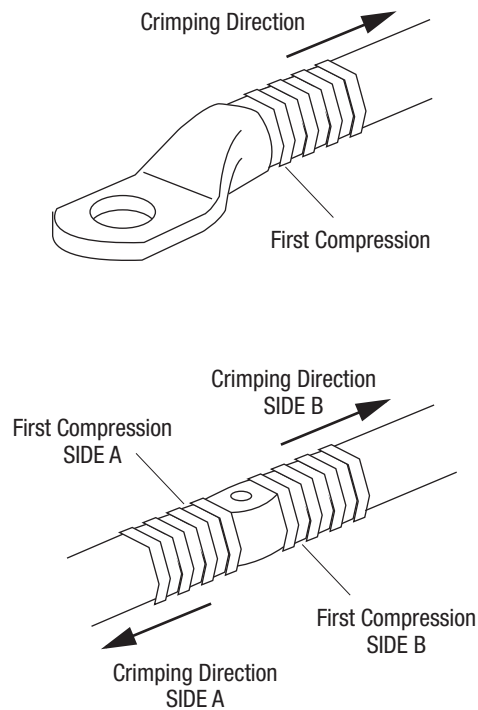

Crimping Cable

1. Insert the properly assembled connector into the crimping head.
2. Pull the trigger to make the crimp.
3. Hold the trigger down until the crimping tool automatically completes the cycle.
4. The crimp cycle automatically stops when complete, and the jaws automatically retract when the trigger is released.
5. Position the crimping tool for next crimp. Repeat Steps 2 and 3 for the number of crimps as described in this manual.

WARNING

An incomplete crimp can cause a fire.

Use proper die, connector, and cable combinations. Improper combinations can result in an incomplete crimp.

Failure to observe these warnings could result in severe injury or death.

Maintenance

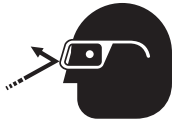
	⚠ WARNING
	<p>Wear eye protection when operating or servicing this tool.</p> <p>Failure to wear eye protection could result in serious eye injury from flying debris or hydraulic oil.</p>

	⚠ WARNING
	<p>Do not use solvents or flammable liquids to clean the tool body. Solvents or flammable liquids could ignite and cause serious injury or property damage.</p>

	⚠ WARNING
	<p>Pinch points:</p> <ul style="list-style-type: none"> • Remove battery before changing dies, adapters, or jaws. • Keep hands away from the crimping tool head when crimping. <p>Failure to observe these warnings could result in severe injury or death.</p>

Daily
Before use:

1. Inspect the tool for wear or damage, such as cracks, gouges, or chips.
2. Inspect the tool for damage.

After use:

1. Use a damp cloth and mild detergent to clean the housing. Allow the housing to dry.
2. Place the tool in the carrying case and store in a cool, dry place.
3. If necessary, recharge the batteries. Refer to the instructions supplied with the battery charger.

Monthly

Thoroughly clean all surfaces.

Annually or After 35,000 Crimps

Send the tool to a Greenlee Authorized Service Center for inspection.

Note: For Warranty Service or Repair, contact Greenlee customer service at 800-435-0786.

Troubleshooting

Before You Begin

1. Make sure that the battery is charged. Recheck the battery after several minutes to make sure the battery is holding its charge.
2. Use a **nonflammable** contact cleaner or pencil eraser to clean the electrical contacts on the battery and tool.
3. Reinstall the battery and check the tool again.

Problem	Possible Cause	Probable Remedy
Tool is inoperative.	Continuous use causes tool to become too hot and automatically switch off.	Allow approximately 3 to 5 minutes of time to cool down.
	Dirt, contaminants, etc., in jaw area of tool.	Clean tool.
	Tool components worn or damaged.	Return tool to a Greenlee Authorized Service Center.
Motor is inoperative.	Low or uncharged battery.	Try known charged battery. Inoperative battery may be discharged or may have reached life expectancy.
	Broken switch components.	Return tool to a Greenlee Authorized Service Center.
LED glows for 20 seconds.	Battery charge low.	Charge or replace battery.

Note: For Warranty Service or Repair, contact Greenlee customer service at 800-435-0786.

Die Holders

For EK50ML120GL

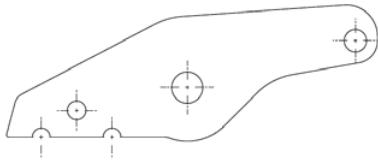

For Panduit and
T&B die sets



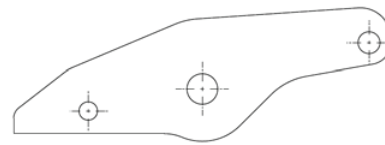









For EK50ML138GL



For Greenlee
CrimpALL® and
Kwik Cycle® dies;
some competitor
dies (Ideal)









CrimpALL® Interchangeable Die Sets

For Coaxial Connectors



CABLE TYPE	DESCRIPTION		DIE CAT. NO.	REMARKS
	CONNECTION	CRIMP SIZES		
 RG58, RG59, RG62AU	BNC/TNC and 3 Piece	0.256" (6.5 mm), 0.213" (5.4 mm), 0.068" (1.7 mm) HEX	PA2034	Common 2-piece and 3-piece BNC/TNC
 RG174, RG59/62, mini-coaxial 75 Ohm	HDTV SMA, True 75 Ohm BNC/TNC, Mini-UHF	0.255" (6.5 mm), 0.197" (5.0 mm), 0.178" (4.5 mm), 0.068" (1.7 mm) HEX & 0.042" (1.0 mm) SQ	PA2648	Common 2-piece and 3-piece BNC/TNC (Kings, ADC, Amphenol, etc.)
 RG59, RG6, Belden 8281, Belden 1694A	HDTV BNC/TNC/CATV "F" True 75 Ohm	0.324" (8.2 mm), 0.255" (6.5 mm), 0.068" (1.7 mm) HEX & 0.052" (1.3 mm), 0.042" (1.0 mm) SQ	PA2649	Common 2-piece and 3-piece BNC/TNC (Kings, ADC, Amphenol, etc.)
 RG6, Belden 1694, Belden 1694A	HDTV BNC/TNC True 75 Ohm	0.278" (7.0 mm), 0.275" (6.9 mm), 0.068" (1.7 mm) HEX & 0.042" (1.0 mm) SQ	PA2657	Common 3-piece BNC/TNC (Kings & ADC HDTV)
 RG58, Mini-59, RG-174, small coaxial	SMA, SMB, Mini-59 BNC/TNC, Mini-UHF	0.128" (3.2 mm), 0.213" (5.4 mm), 0.197" (5.0 mm), 0.178" (4.5 mm), 0.068" (1.7 mm) HEX & 0.042" (1.0 mm) SQ	PA2653	Common 2-piece and 3-piece SMA/SMB/ BNC/TNC & Mini-UHF
 RG58, RG174, AT&T 735, 50 and 75 Ohm	Thinnet, BNC/TNC, Mini-UHF	0.213" (5.4 mm), 0.178" (4.5 mm) 0.068" (1.7 mm) HEX & 0.042" (1.0 mm) SQ	PA2046	50/75 ohm small 2-piece & 3-piece BNC/TNC (Kings, ADC, etc.)
 RG59, RG62, Belden 8281, 50 and 75 Ohm	BNC/TNC and Mini-UHF	0.315" (8.0 mm), 0.252" (6.4 mm), 0.068" (1.7 mm), HEX 0.042" (1.0 mm) SQ	PA2047	75 ohm 2-piece & 3-piece BNC/TNC (Kings, ADC, Amphenol, etc.)
 RG174, RG179 and Small Cable Connection	BNC/TNC	0.178" (4.5 mm), 0.128" (3.2 mm), 0.068" (1.7 mm) HEX	PA2051	Common 2-piece and 3-piece BNC/TNC/SMA/SMB
 RG6 and RG6 Quad, Belden 1694A	BNC and CATV "F" Type & HDTV	0.360" (9.1 mm), 0.324" (8.2 mm), 0.068" (1.7 mm) HEX	PA2045	Common 2-piece and 3-piece BNC/TNC and CATV "F" 2-piece
 RG59, RG6 Video Cable	CATV "F" Type	0.346" (8.8 mm), 0.319" (8.2 mm), 0.256" (6.5 mm) HEX	PA2042	Crimps Ferrules or Sleeves Only
 RG8, RG11, RG213	N-Type	0.429" (10.9 mm), 0.100" (2.54 mm), 0.080" (2.03 mm) HEX	PA2656	Common 2-piece and 3-piece "N"-Type (Kings, ADC, Amphenol, etc.)
 RG8, RG11, RG213, RG216	N-Type, MS39012 Type	0.415" (10.5 mm), 0.095" (2.4 mm) HEX	PA2039	Crimps Pins and Ferrules
 Belden 1855A, 1865A, 1505A, 1505F, 1694A, 1694F, 179DT	HDYV BNC/TNC True 75 Ohm	0.178" (4.5 mm), 0.255" (6.5 mm), 0.278" (7.0 mm), 0.068" (1.7 mm), 0.041" (1.0) HEX	PA2699	Kings, ADC, B&L, Trompeter, Amphenol, Switchcraft

CrimpALL® Interchangeable Die Sets (cont'd)

For Modular Plugs

DESCRIPTION				DIE CAT. NO.	REMARKS
CABLE TYPE	CONNECTION	CRIMP SIZES			
 RJ45 - 8P8C (8 Pin)	Flat/Round, Solid/Stranded	RJ45 Unkeyed WE and SS	PA2061	Western Electric (WE)/Stewart Connector (SS)	
 RJ11 & RJ12 - 6P6C, 6P4C, 6P2C	Flat/Round, Solid/Stranded	RJ11 & RJ12 Unkeyed WE and SS	PA2062	Western Electric (WE)/Stewart Connector (SS)	
 RJ22 Handset - 4P4C (4 Pin)	Flat/Round, Solid/Stranded	4 Pin Handset WE and SS	PA2063	Western Electric (WE)/Stewart Connector (SS)	
 RJ45 - 8P8C (8 Pin)	Flat/Round, Solid/Stranded	RJ45 Unkeyed AMP	PA2064	AMP (Tyco) Inc. Connectors Only	
 RJ50 - 10P10C (10 Pin)	Flat/Round, Solid/Stranded	RJ50 Unkeyed WE and SS	PA2068	Virginia Plastics (VP)	
 British Telecom 6 Pole Plug	Flat/Round, Solid/Stranded	BT 6 Pole	PA2032	British Telecom Plugs Only	
 RJ45, Molex Connectors for 5.0 dia. Cable	5.0mm Dia. Round, Shielded (STP)	RJ45 STP Molex Connectors, 5.0 mm dia. cable	PA2673	Molex	
 RJ45, AMP/Molex Connectors for dia. Cable	6.0mm Dia. Round, Shielded (STP)	RJ45 STP AMP & Molex, 6.0 mm dia. cable	PA2674	AMP (Tyco) Inc. & Molex	

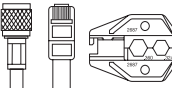
For Specialty Crimpers

DESCRIPTION				DIE CAT. NO.	REMARKS
CABLE TYPE	CONNECTION	CRIMP SIZES			
 RJ45 WE/SS & RG6/RG6 Quad CATV "F"	UTP 4-Pair & RG6/RG6 Quad	RJ45 WE/SS 8-pin & 0.360" (9.1mm) HEX/ 0.324" (8.2 mm) HEX	PA2687	For standard RJ45 WE/SS Modular Plugs & 1-piece RG6/RG6 Quad CATV "F" conns.	
 HDMI Equivalent	HDMI	24 AWG connector components, 24 AWG HDMI cable	PA4003	<ul style="list-style-type: none"> Precision cast 4140 steel for durability High Tensile steel cutting blades for long life Error-proof design avoids misalignment 	

CrimpALL® Interchangeable Die Sets (cont'd)
For Insulated Terminal Crimpers

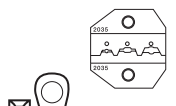
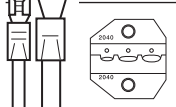
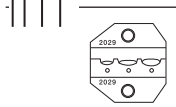
DESCRIPTION			DIE CAT. NO.	REMARKS
CABLE TYPE	CONNECTION	CRIMP SIZES		
	Insulated Terminals and Lugs	Solid or Stranded Wire, 22-10 AWG (0.34-6 mm ²)	PA2035	For Large Professional Terminals (Panduit, T & B, etc.)
	Insulated Terminals and Lugs	Solid or Stranded Wire, 22-12 AWG (0.34-4 mm ²)	PA2040	For Standard Commercial Terminals (Hardware Store Brands)
	Insulated Terminals and Lugs	Solid or Stranded Wire, 26-14 AWG (0.10-2.5 mm ²)	PA2029	For Smaller Wire Barrel Terminals

For Non-Insulated Terminal Crimpers

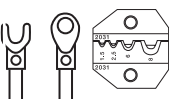
DESCRIPTION			DIE CAT. NO.	REMARKS
CABLE TYPE	CONNECTION	CRIMP SIZES		
	Non-Insulated Terminals and Lugs	Solid or Stranded Wire, 22-8 AWG (0.34-0.10 mm ²)	PA2031	For Standard Commercial Terminals

For Open Barrel, Box and Terminal Systems

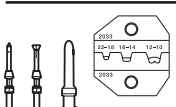
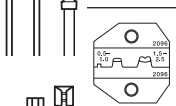
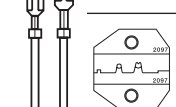
DESCRIPTION			DIE CAT. NO.	REMARKS
CABLE TYPE	CONNECTION	CRIMP SIZES		
	Open Barrel Non-Insulated Terminals, Narrow Lugs and Power Contacts	Solid or Stranded Wire, 22-10 AWG (0.34-6 mm ²), F Type*	PA2033	For Standard Commercial Terminals
	Open Barrel Non-Insulated Terminals, Wide Lugs and Power Contacts	Solid or Stranded Wire, 22-14 AWG (0.34-2.5 mm ²), F Type*	PA2096	For Standard Commercial Terminals
	Open Barrel D-Sub Contact Pins RS-232	Solid or Stranded Wire, 28-20 AWG (0.08-0.50 mm ²), F Type*	PA2097	For Standard D-sub Pins Only; not for HD D-sub

For Wire Ferrules

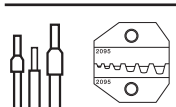
DESCRIPTION			DIE CAT. NO.	REMARKS
CABLE TYPE	CONNECTION	CRIMP SIZES		
	Insulated & Non-Insulated Wire Ferrules	Solid or Stranded Wire, 22-10 AWG (0.34-6 mm ²)	PA2095	For DIN or US Type Wire Ferrules

Illustration

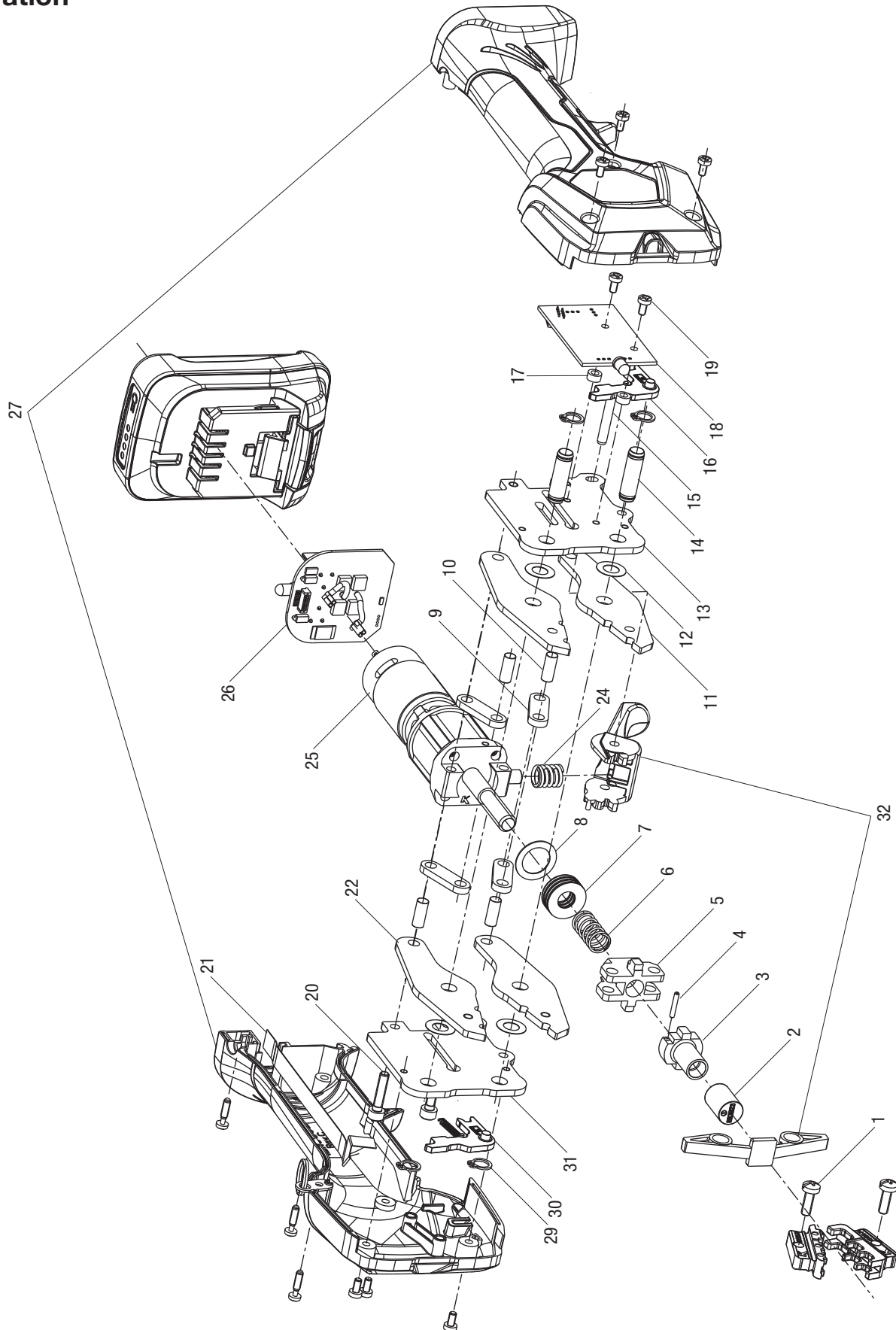

Parts List

Key	Part No.	Description	Qty
	52068843	Driver assembly with gearbox and spindle nut	
2		Grease retainer cap.....	1
3		Spindle nut.....	1
4		Spring-type straight pin ISO 13337-2 x 12.....	1
5		Yoke	1
6		Compression spring.....	1
7		Cup spring DIN 2093-18 x 0.5 x 8.2.....	7
8		Shim washer DIN 988-13 x 19 x 0.5.....	1
25		Drive assembly 46-gearing/10.8V engine	1
	52068844	Crimp head (complete) 12 mm	
1		Screw, cross recess head M4 x 12	2
9		Linkage arm	4
10		Bolt ø5 x 12.....	4
11		Crimp head bracket with hole 4.2 mm.....	2
12		Shim ring DIN 988-7 x 13 x 0.2 steel.....	4
13		End plate, left	1
14		Bolt ø7 x 12.....	2
15		Parallel pin, hardened ISO 8734-4 x 28.....	1
16		Gear lever.....	2
20		HSH cap screw ISO 4762-M4 x 18 (DIN 912)	2
22		Crimp head bracket with thread M4	2
24		Compression spring DA 9.8 x L 14, x D 1.4.....	1
30		Retaining ring DIN 471-7 x 0.8	4
31		Extension spring DA 3.52 x L 8.7 x D 0.32	1
32		End plate, right.....	1
	52068849	Crimp head (complete) 13 mm	
1		Screw, cross recess head M4 x 12	2
9		Linkage arm	4
10		Bolt ø5 x 12.....	4
11		Crimp head bracket with hole 4.2 mm.....	2
12		Shim ring DIN 988-7 x 13 x 0.2 steel.....	4
13		End plate, left	1
14		Bolt ø7 x 12.....	2
15		Parallel pin, hardened ISO 8734-4 x 28.....	1
16		Gear lever.....	2
20		HSH cap screw ISO 4762-M4 x 18 (DIN 912)	2
22		Crimp head bracket with thread M4	2
24		Compression spring DA 9.8 x L 14, x D 1.4.....	1
30		Retaining ring DIN 471-7 x 0.8	4
31		Extension spring DA 3.52 x L 8.7 x D 0.32	1
32		End plate, right.....	1

Parts List (cont'd)

Key	Part No.	Description	Qty
	52068845	Switch board assembly	
17		Distance roll ø6 x 3	2
18		Plate for mini 10.8V	1
19		Screw DIN 7985 M3 x 6-4.6-Z zinc plated	2
	52068846	Cup spring assembly	
6		Compression spring	1
7		Cup spring DIN 2093-18 x 0.5 x 8.2	7
8		Shim washer DIN 988-13 x 19 x 0.5	1
32	52068847	Release lever and spacer	
	52068848	Tool housing (complete) 12 mm jaw	
27		Housing assembly, green	1
	52068850	Tool housing (complete) 13 mm jaw	
27		Housing assembly, green	1
Replacement Parts			
21	52068569	Flat flexible cable 8-pole L 131.5	1
26	52068582	Programmed circuit board	1