



D2X IP Phone User Manual

Version: 1.0

2019-02-26

Copyright © 2019 ATCOM TECHNOLOGY

Copyright © 2019 ATCOM Technology CO., LTD. All rights reserved. No parts of this publication may be reproduced or transmitted in any form or by any means, electronic or mechanical, photocopying, recording or otherwise, for any purpose, without the express written permission of ATCOM Technology CO., LTD. Under the law, reproducing includes translating into another language or format.

Caution:

Change or modifications to this product not expressly approved by ATCOM, or operation of this product in any way other than as detailed by this User Manual, could void your manufacture warranty.

This document is subject to change without notice, if the content of document is difference from the actual IP phone feature, please refer to the actual IP phone.

Contact ATCOM

Overview of ATCOM

ATCOM is the leading VoIP hardware manufacturer in global market. We have been keeping innovating with customer's needs oriented, working with partners to establish a total solution for SMB VoIP with IP phone.

With more than ten years of experience in R&D, manufacturing and service in the VoIP industry. ATCOM mission is "creating maximum value for voice over IP applications". We are dedicated to providing competitive IP phones and other IP voice terminals for equipment manufacturers, hosted PBX suppliers and telecoms operators. We offer extremely valuable IP voice solutions to enterprises.

Until now, our VoIP products have been available in 60+ countries and used by millions of end users.

Contact Sales

Address	Area C, A2F , Block 3 ,Huangguan Technology Park , #21 Tairan 9th Rd, Chegongmiao , Futian District , Shenzhen China
Tel	+ (86) 755-83018618-1
FD2X(w)	+ (86) 755-83018319
E-mail	sales@atcom.com.cn

Contact Technical Support

Tel	+ (86) 755-83018618-2
E-mail	Support@atcom.com.cn

Website Address: <http://www.atcom.cn/>

Content

Contact ATCOM	3
1. Overview of D2X	7
1.1. Interface	8
1.2. Hardware	8
1.3. Software	8
1.4. Network	9
1.5. Management and Maintenance	9
1.6. Protocol	9
1.7. Compliant and Certified Standard	10
1.8. Packing list	10
1.9. Connection	10
1.10. Installation	11
2. Keypad and GUI	13
2.1. Keypad	13
2.2. Starting	15
2.3. Standby	16
3. Call Function	18
3.1. Answer the calls	18
3.2. Make Calls	19
3.3. Multiple line dial-up	20
3.4. Call Hold	21
3.5. Call Transfer	21
3.6. Mute calls	22

3.7. 3-Way Conference	22
3.8. Hang up the phone	23
3.9. Voicemail	24
4. Configuration	24
4.1. Guide document	25
4.2. Status info	26
4.3. Multi-Scene	28
4.3.1. Configure the multiple scene from the LCD setting	28
4.3.2. Configure the multiple scene from the Webpage	29
4.4. Call Features	30
4.4.1. Call Forward	31
4.4.2. Call Waiting	34
4.4.3. Auto Answer	35
4.4.4. DSS Keys	36
4.4.5. DND	41
4.4.5. Key as Send	43
4.4.6. Hotline	44
4.4.7. Anonymous Call	44
4.5. Contacts	46
4.6. History	52
4.7. Message	55
4.7.1. Voice Mail	55
4.8. Settings	56
4.9. Display	73
5. Advanced Feature	75

5.1. Codecs	75
5.2. Capture and Upgrading	76
5.3. Auto Provision	77
5.4. Export & Import configuration file	79
5.4.1. Export configuration file	79
5.4.2. Import configuration file	80
5.5. Export System log	80
5.6. Dial plan	81
5.6.1. Replace Rule	82
5.6.2. Dial-now	83
5.6.3. Area Code	84
5.6.4. Block Out	85
6. FAQ	86
6.1. How to reset to factory	86
6.2. Upgrade the firmware on safe mode	87
6.3. How to make IP Peer to Peer call	87
7. Trouble shooting	88
7.1. The phone is failed to register to SIP server	88
7.2. The phone is failed to gain IP address	89
7.3. Only one party can hear from another on calling	89
8. Abbreviation	89
9. FCC Caution	90

1. Overview of D2X



D2X

Type	POE	Power adapter	Wi-Fi	1000M
D20	No	Necessary	No	No
D21	Yes	Optional accessory	No	No

1.1. Interface

Power Input	DC 5V-600mA or POE
LAN Port	RJ45
PC Port	RJ45
Headset Jack	RJ9
Handset Jack	RJ9

1.2. Hardware

LCD	128*64
CPU	250MHz Dual-Core
LED Indicator	1 Status Light

1.3. Software

- Sip 2.0 (RFC3261) and other related SIP RFCs
- 6 SIP accounts registration, 2 SIP line keys
- STUN
- Jitter Buffer, VAD,CNG
- G711A, G711U, G722, G726-16, G726-24, G726-32, G726-40, G729, L16, iLBC_13_3, iLBC_15_2, OPUS
- Echo Cancellation
- SIP Domain name, Authentication and Backup SIP Server
- DTMF (RFC2833, Inband, SIP INFO)
- Call transfer, Call forward, 3-way conference, Call hold, Call back
- DND(Do Not Disturb), Auto answer, Blacklists, Block Call-ID, Block Anonymous call, Dial plan, IP call
- Phone book with 1000contacts and 50 blacklists
- Call History with 400 records include answered calls, missed calls, dialed calls and forward calls
- Auto update via HTTP, HTTPS, FTP, TFTP, DHCP, RPS and PNP
- Syslog
- SNTP,NTP
- Customized Ringtone
- Daylight Saving time
- VLAN, OpenVPN, Span to PC port, QoS

- 802.1X, LLDP
- WEB access with different login level
- Soft button: soft button *4
- Redundancy SIP server
- Multi-language: English, French, Hebrew, Russian, Spanish, Chinese, Persian, Polish, Portuguese, Turkish, German, Italian
- Support Multi-scene feature scenarios
- Support Guide document

1.4. Network

- LAN/PC: Support Bridge mode
- Support VLAN
- Support Open VPN
- Support DHCP, STATIC IP
- Primary/Secondary DNS Server
- Support QoS
- Support LLDP
- Support 802.1X
- Support Span pc port
- Web access via HTTP&HTTPS

1.5. Management and Maintenance

- Support firmware updating under safe mode
- Support different level user management
- Configuration via web , keyboard
- Support multi-language
- Firmware and configuration file auto provision
- Support system log

1.6. Protocol

- IEEE 802.3 /802.3 u 10 Base T / 100Base TX
- DHCP: Dynamic Host Configuration Protocol
- SIP RFC3261, RFC3262, RFC3263, RFC3264, RFC3265, RFC2543, RFC3489, RFC3842, RFC3515, RFC2976, RFC3428, RFC2327, RFC2782, RFC1889
- TCP/IP: Transfer Control Protocol/Internet Protocol
- RTP: Real-time Transport Protocol
- RTCP:RTP Control Protocol
- DNS: Domain Name Server

- TFTP: Trivial File Transfer Protocol
- HTTP: Hypertext Transfer Protocol
- FTP: File Transfer Protocol

1.7. Compliant and Certified Standard

- CE:
- Comply with ROHS in EU
- Comply with ROHS in China



-
- Operation temperature: -10 ~ 50° C
- Storage temperature: -10 ~ 50° C
- Humidity: 10 to 90% no dew

1.8. Packing list

Model	D2X
Telephone	1 Unit
Handset	1 Unit
Handset cable	1 Unit
Stand bracket	1 Unit
Wall bracket	1 Unit
Power adapter	Optional for D21 Standard for D20
Network Cable	1 Unit, 1.5 meters
Quickstart Guide	1 Unit
Headset	Optional

1.9. Connection

Connect to network cable

D2X is able to be connected with network via LAN port. Under the Bridge mode, other devices (Laptop, IP phone) is able to access network via the PC port of D2X.



1.10. Installation

1.1. Stand bracket installation instruction

- A. Bottom up the IP phone, press the joints of stand bracket into the slots and push it to the right to fasten:

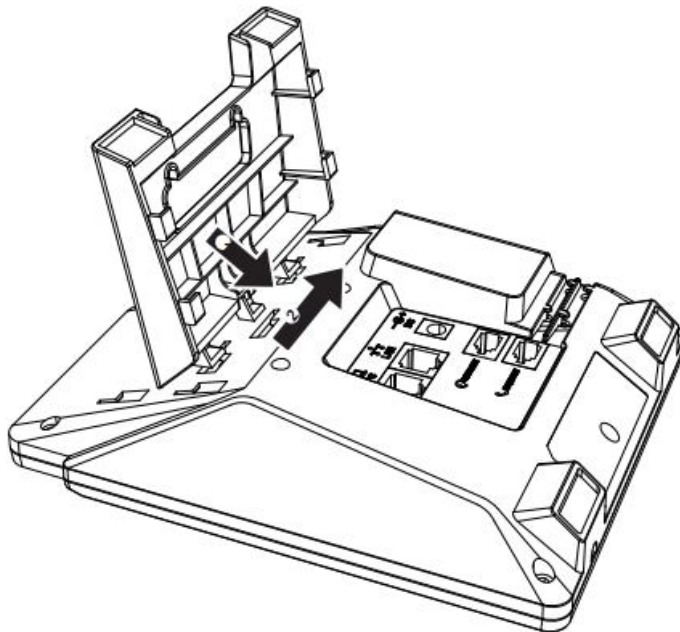

B. After installation, the picture is as below:

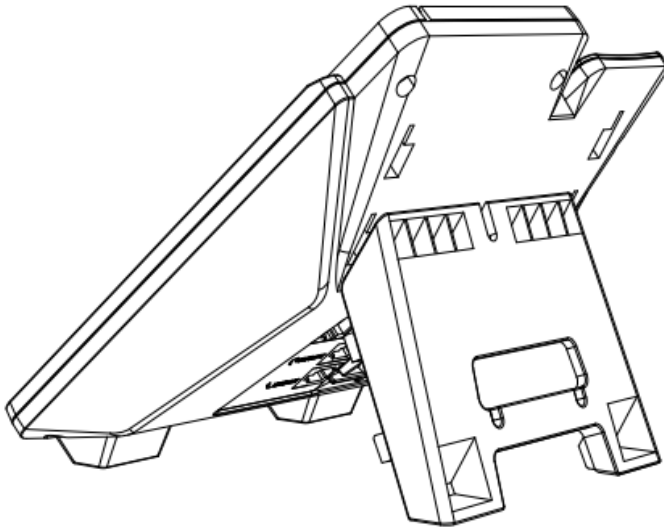

C. Remove the stand bracket:

Push the joint of stand to left and pull the stand according to the direction of the arrow. When the joints are pulled out of the slot, you can take off the stand bracket

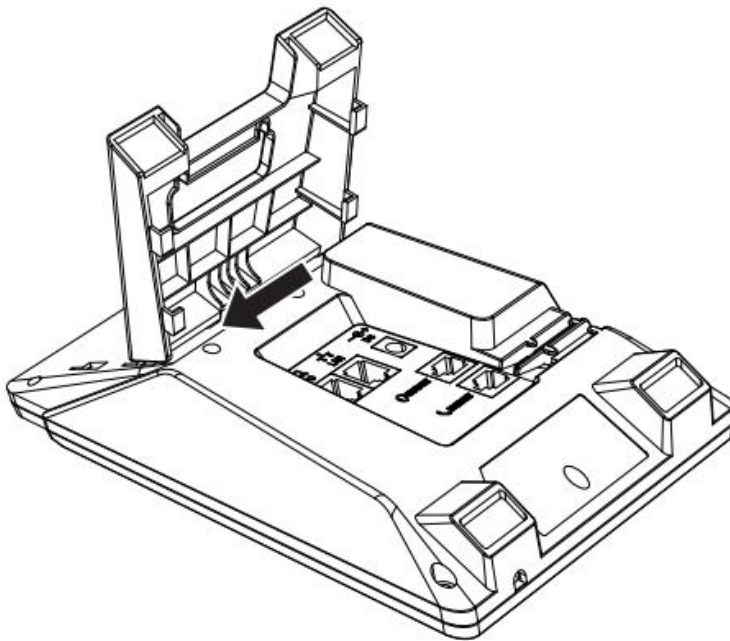

1.2. Connecting port introduction

From as below picture show the connecting port:

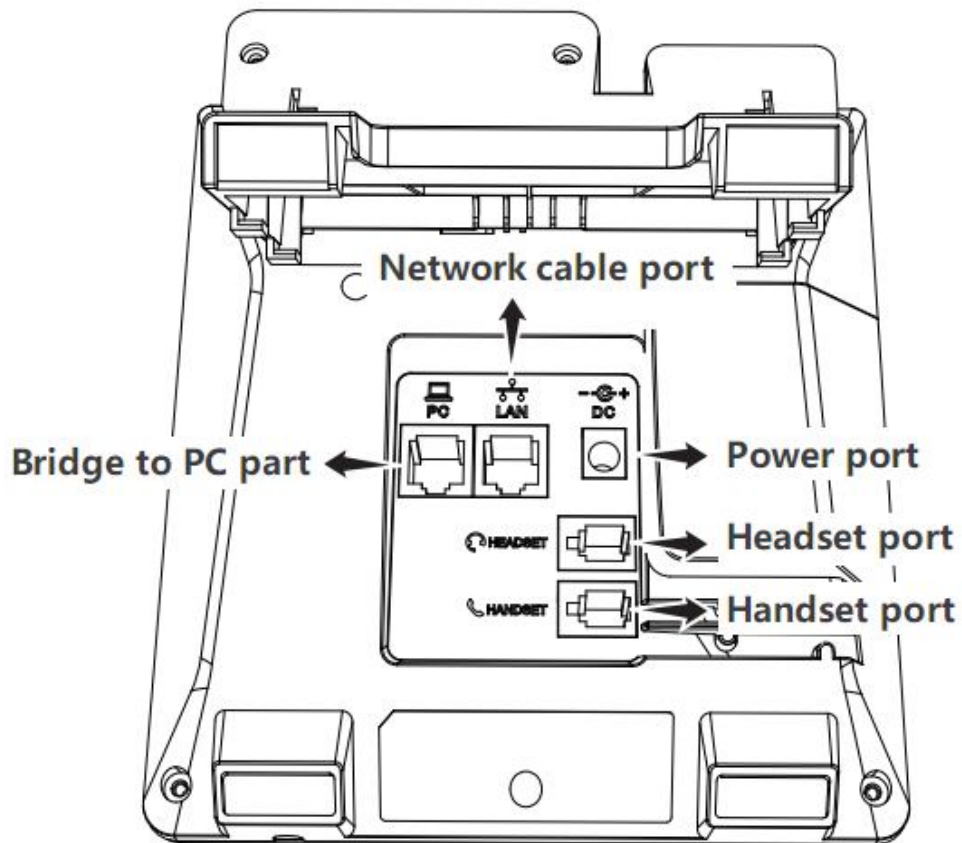





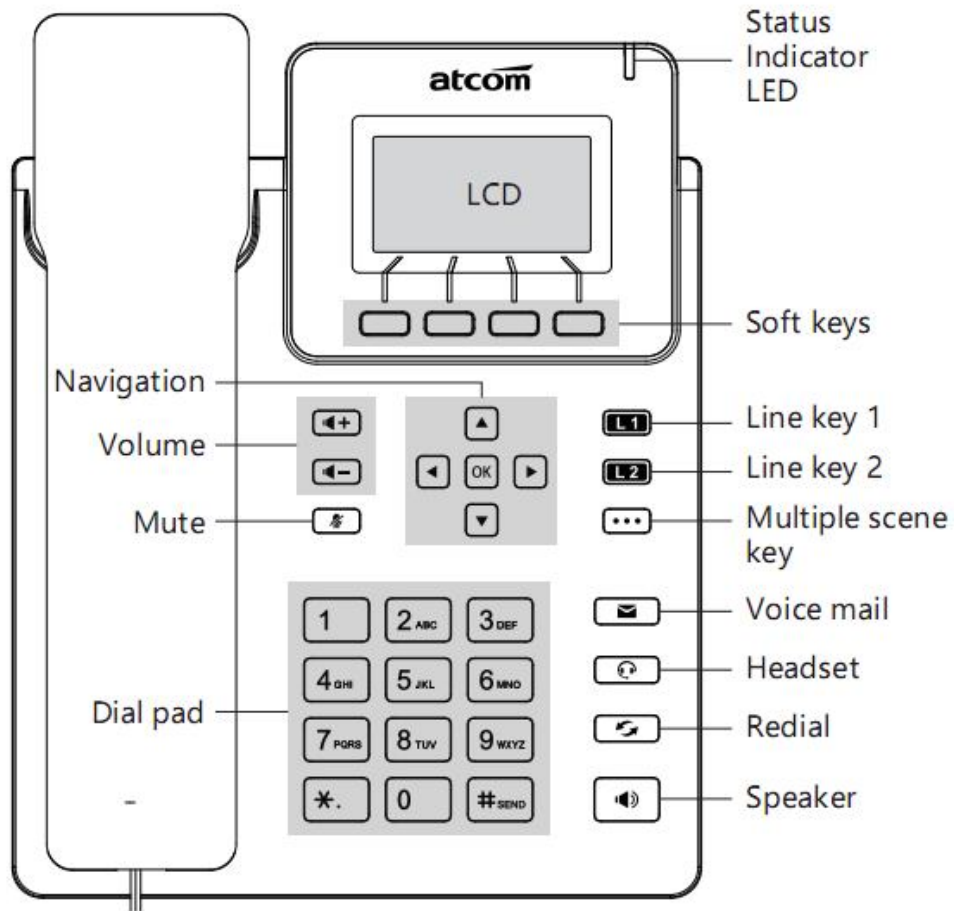





2. Keypad and GUI

2.1. Keypad



<p>Soft Keys</p>	<p>Press to select a function which displayed at the softkey zone of screen</p> <p>Display all optional functions at the last line of LCD screen.</p> <p>It can change the soft keys feature from the multiple scene key.</p>
<p>Status Indicator LED</p>	<p>Indicates the phone's status,</p> <ul style="list-style-type: none"> ➤ If the phone is being started ,the LED is on ➤ If the phone is standby, the LED is off ➤ If there is income calling, the LED will blink at 120ms on, 120ms off. ➤ If there is a new message, the LED will blink at 600ms on, 600ms off.
<p>LCD Screen</p>	<p>All information such as date, time, phone number, incoming caller's ID(if available),line/call status, extension numbers and the soft key features are displayed on it.</p>
<p>Dial pad</p>	<p>Entering numbers or characters.</p>

Navigation keys	Allows users to navigate(left, right, up, down).Press  can enter "Directory". Press  can enter "History".
	Multiple scene key, can change the soft key scene, add the BLF key, the most can change the soft key scenes 3 times, and add 12 BLF programmable keys.
 	Adjust the volume (speaker/handset/headset/ring). Volume level will be displayed on LCD when pressing volume key.
	Confirm users' operation and show status when D2X is idle.
The fourth soft key	Default Menu key can enter menu settings.
	Pick up and hung up under the speaker mode.
	Mute the mic in a conversation by pressing the Mute button; this prevents the person on the active call from hearing what you or someone else in the room is saying. To un-mute, press the Mute button again.
	Pick up and hung up under headset mode.
	Check the Voicemail status.
	Redial the last dialed number

2.2. Starting

1. When start on the phone, it turns to standby status in about 50 seconds.

Welcome

2. After absolute boot up (first use or after reset to factory setting), User can select the Language and time manually.

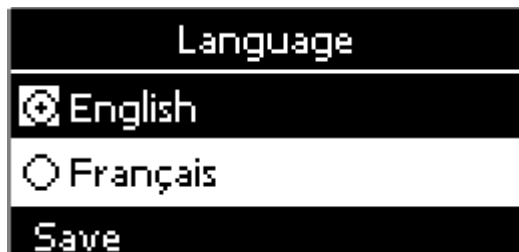



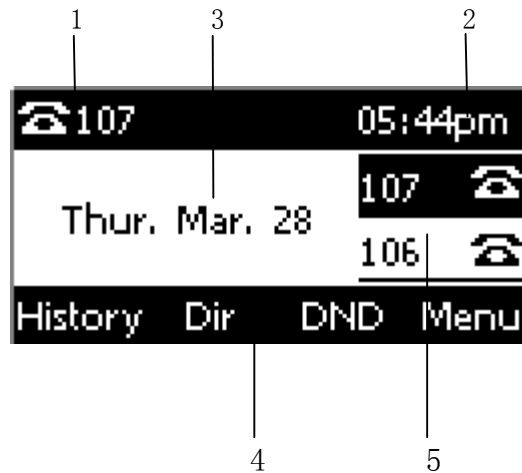











2.3. Standby



Area Item	Description
1	Show the default account and indicate the call status
2	Time
3	Date
4	Softkey: "History", "Directory", "DND," "Menu"
5	Line keys

Icon on Standby UI

Icon	Description
	The account is registered successfully.
	The account is not registered successfully.
	The line is being occupied for dialing.
	New incoming call
	Call hold.
	Call is talking
	Unavailable Network.
	Calling via handset

	Calling via Speaker.
	Calling via headset.
	Call Forward is activated.
	New Voicemail.
	Auto-Answer is activated.
	DND is activated



3. Call Function

3.1. Answer the calls



When there is an incoming call, phone will remind user with ringing. There are some ways to answer the call:

A. Answer by handset



Pick up the handset and talk with the caller. If you want to hang up, just put back the handset. When you are talking with the handset and want to switch to speaker or headset mode, please

press  key or  key, and then put down the handset.

B. Answer by speaker

Press  key and talk with callers by built-in Micro-phone and Speaker. If you want to hang up, please press  key again. Switch calling or talking into handset mode by lifting the handset under speaker mode. Press  key will switch calling or talking into headset mode.

C. Answer by headset

Keep your microphone connected with the RJ9 headset jack, when there is an incoming call, press  and talk with the caller. If you want to hang up, please press  again.

Pressing  can change calling or talking into speaker mode, and lifting the handset switches to handset mode.

D. Answer by line key

If the line key is blink when there is an incoming call, you can press the line key to answer the call.

E. Answer by soft key

It could show the ringing interface when there is an incoming call, you can press the '**Answer**' key to answer the call.

3.2. Make Calls

A. Use the handset

Pickup the handset, the LCD will show the current account (user is able to switch from account 1 to account 6 by pressing the **up** key or **down** key beside the LCD). Press soft key "**Send**" to dial the number. When you hear the tones of "du~~du~~" and the phone number your dialed is being displayed on the LCD, the phone at the side of being called should be ringing. If the called party answers this calling, the call is established and the calling timer is started immediately.

B. Use the speaker

Press  key, the LCD will show the current lines (user is able to switch from account 1 to account 6 by pressing the **up** key or **down** key beside the LCD). Input the phone number and press soft key "**Send**" to dial the number. When caller hear the tones of "du~~du~~" and the phone number your dialed is being displayed on the LCD, the phone at the side of being called should be ringing. If the called party answers this calling, the call is established and the calling timer is started immediately.

C. Use the headset

Press  Key, the LCD will show the current lines (user is able to switch from account 1 to account 6 by pressing the **up** key or **down** key beside the LCD). Input the phone number and press soft key "**Send**" to dial the number. When caller hear the tones of "du~~du~~" and the phone number your dialed is being displayed on the LCD, the phone at the side of being called should be ringing. If the called party answers this calling, the call is established and the calling timer is started immediately.

D. Use the send key

Input the phone number and press the soft key "**Send**" to dial account.

E. Dial from phone book

1. Press the **Menu** soft key to enter the menu and choose "**Contact**" option. Press "**Enter**" soft key and then find the contact person by navigation keys. When the certain contact person is highlighted, press "**Dial**" or just pick up the handset to call this number.
2. Pick up the handset, press "**Contact**" soft key, then find the contact person and press "**Dial**" soft key.
3. Pick up the handset, press  and enter "**Contact**", then find the contact person and press "**Dial**" soft key.



F. Dial from call history

1. Press the '**Meun**' soft key to enter the menu and choose "**History**" option, then select one of call history entry, and press "**Dial**" soft key or pickup the handset to call this number.
2. Pickup the handset, press "**History**" soft key, then select one of call history entry, and press "**Dial**" soft key to call this number.
3. Pickup the handset, press  and enter "**Call History**", then select one of call history entry, and press "**Dial**" soft key to call this number.

3.3. Multiple line dial-up

D2X supports up to 24 concurrent calls. If there is a new incoming call when you're talking on D2X, the new incoming call will be displayed on LCD and status indicator LED will be fast blinking. User can press soft key "Hold" then press "Answer" to receive the new incoming call.

3.4. Call Hold

The current calling will be hold by pressing soft key "**Hold**" or , and the held call will be resumed after pressing soft key "**Resume**" or  or the corresponding line key. Even on 3-way conference calling, the conference will be held after pressing "**Hold**" key, and be resumed to 3-way conference after pressing "**Hold**" Key again. Remember the conversation is still on hold without being ended even if hung up under the status of hold.

3.5. Call Transfer

1. Attended call transfer

The attended transfer allows user to call a third-party before transferring the calling.

While calling, press the "**Transfer**" soft key to hold the current call and dial the target number you want to transfer to on the activated line and press "**Send**" soft key to call that number. After the target party answers the call, press "**Transfer**" soft key again to complete the transfer.

If the target number has been setup in the current BLF list, and you have already finished the necessary setup on Webpage of D2X, there is an easier way to complete the attend transfer. While calling, press the corresponding BLF key of the target number and then press the "**Transfer**" soft key, the attend transfer will be achieved.

2. Blind call transfer

The blind transfer allows user to transfer a call without speaking to the third party. On the user side, the call will be ended as soon as the target phone number is dialed.

Operating steps: Press "**Transfer**" soft key to get more option, then press "**Blind**" soft key, input the transfer target number and press "**Send**" soft key.

If the target number has been setup in the current BLF list, and you have already finished the necessary setup on Webpage of D2X, there is an easier way to complete the Blind transfer. While calling, press the corresponding BLF key of the target number, the blind transfer will be achieved.

3.6. Mute calls

The input audio will be not transmitted to peer phone after pressing  key, and the phone will be muted even switched among different modes of speaker, handset and headset.

To un-mute, just press  key again.

3.7. 3-Way Conference

1. While on calling, press the soft key **"Conf"**, input the 3rd party's phone number and then press the softkey **"Dial"** or press the soft key **"Conf"** and press the corresponding BLF key to invite the 3rd party to join a conference call.
2. After the third party answers the call, pressing **"Conf"** key again to establish the 3-way conference.



1. New call

- 1.1. While on the Conf call, the initiator can press the **'New call'** soft key to dial the call, then press the **'Conf'** soft key join the conf room;
- 1.2. Or when there is a new call incoming, answered the call, and press the **'Conf'** soft key, the more can add 3-ways in the conf room.

2. Mut

2.1. While on the Conf call, the initiator can press the '**Mute**' soft key to forbidden the chosen conf member speak;

2.2. After '**Mute**', the initiator can press '**UnMute**' to recover the chosen ways speak.

3. More

3.1. While on the Conf call, the initiator can press '**More**' soft key to switch the first two keys feature.



4. Remove

4.1. While on the Conf call, the initiator can press the '**Remove**' soft key to remove the chosen conf member, the remove talking would be end the call.

4.2. If all the conf member be removed, the conf call would be ended.

5. Hold

5.1. While on the Conf call, the initiator can press the '**Hold**' soft key to hold the current conf call, and press the '**Resume**' would recover the call.

6. End

6.1. While on the Conf call, the initiator press the 'End' key can end the conf call.

3.8. Hang up the phone

1. Softkey hang up

While on calling, press the softkey "**End Call**" to hang up.

2. Handset hang up

Put back the handset at handset mode, the current calling will be hung up.

3. Speaker hang up

Press  key at speaker model, the current calling will be hung up.

4. Headset Hang up

Press  key at headset model, the current calling will be hung up.

5. Hang up one line call

Press the hook to hang up the current calling when 2 calls happened simultaneously.

3.9. Voicemail

D2X has a  key for entering voicemail box and indicating new voicemail. Press

 key to enter the menu to configure voicemail number if you have never configured it previously. Otherwise, the voicemail number will be called after pressing it.

4. Configuration

Press the **Menu** soft key to enter the Main Menu:

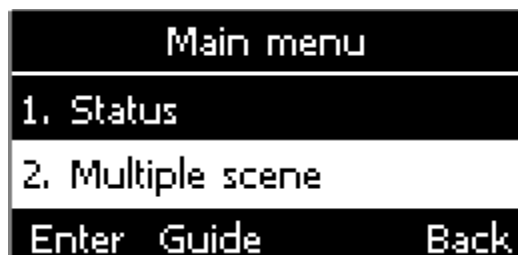

Move the navigation key and press the softkey "**Enter**" or input the corresponding Number key
Select the item of Main Menu:

Number Key “1”	Enter “Status”
Number Key “2”	Enter “Multiple scene”
Number Key “3”	Enter “Feature”
Number Key “4”	Enter “Directory”
Number Key “5”	Enter “History”
Number Key “6”	Enter “Message”
Number Key “7”	Enter “Settings”
Number Key “8”	Enter “Display”

4.1. Guide document

Press the 'Guide' can enter the Guide help document feature under the main menu, please check as following of photo:



Press the  Down key or the number can enter the corresponding guide feature.

Press number 1	Enter the Introduction for Panel key
Press number 2	Enter the One-click Use
Press number 3	Enter the How to enter the menu
Press number 4	Enter the how to set the customize panel , to introduce how to use the multi-scene feature
Press number 5	Enter the how to use hot desking
Press number 6	Enter the how to make a call feature
Press number 7	Enter the how to answer the call feature
Press number 8	Enter the how to transfer the call feature
Press number 9	Enter the how to build the phone multi-conference feature
Press number 10	Enter the Cautions

4.2. Status info

It's able to check the status info via LCD Display or Web.

And the basic status and details status will be optional displayed on LCD display

1. Basic Status—IP address.MAC address. Firmware version。
2. Details Status—Network info. Production info and Account info in details.

Basic Status

You're able to check the basic status in both ways as below:

1. **Press the key**  **on standby.**
2. **Press the Menu soft key and select the "Status" of Main Menu.**
3. **Move the navigation key, the status display the Model, IP, MAC, Firmware, More**

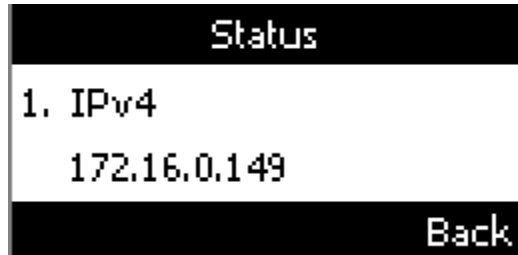

Details Status

Select "**More**" and then press the softkey "**Enter**" to check details info, and move the navigation key to check more.

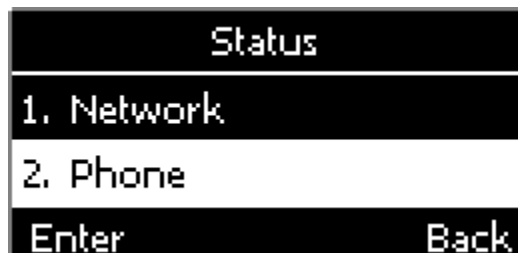



Press the softkey "**Enter**" to check status info, and "**Back**" to return the Basis Status page.

Check the Status info via Web

1. Check the IP address of IP phone;
2. Type the IP address on a web browser;
3. Input the username and password, the default user and password for Administrator is (admin, admin), for general user is (user, user), and then press "**Enter**".
4. By default, the Status info will be displayed.

4.3. Multi-Scene

Press the  multiple scene key can switch to other softkey mode, and the default scene softkey feature is BLF.

in our default setting you can press the  scene key change 1 softkey scene, User can add more softkey scenes from the web and LCD setting, the most can switch 4 different softkey scenes and configure 16 BLF keys.

Under multi-scene softkey mode, user can long press the softkey to configure the BLF key.

When the BLF account is ringing or talking, the BLF light status would be change.

4.3.1. Configure the multiple scene from the LCD setting

1. Please press the **Menu** key.
2. Enter to the **Multiple Scene** .User can choose Enabled or Disabled the multiple scene feature.

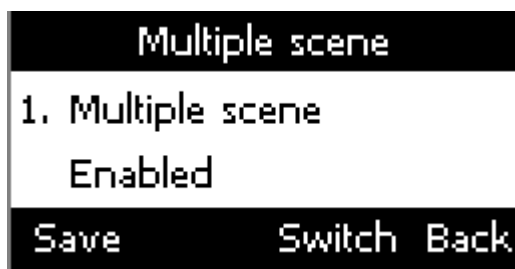

3. When under the **Multiple scene**, you can press **the down** key enter to the **Scene settings**, then user can enable the **Scene1**, **Scene2** or **Scene3**.

Only **Scene1** is enabled as default.



4. Enter to the **Scene1** interface, press **the down** key, user can configure the blf account or switch to another programmable feature.

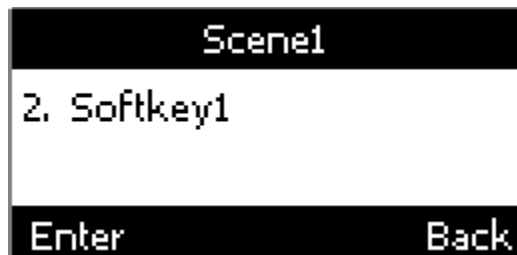

4.3.2. Configure the multiple scene from the Webpage

Via web: **DSS keys**→**Multiple scenario**

You can see the factory softkey mode is default scene,

And you can choose **Enabled** or **Disabled** to add the scenes, can add 3 multiple scenes in total.

Basic Account Network **DSS Keys** Phone Contacts

Line Keys

Programmable Keys

Multiple Scenario

Multiple Scenario Enabled ▾

Scenario 1

Name

Default Scenario

Add To Scan List Enabled ▾

Key	Type	Value	Label	Account
SoftKey1	History ▾			Auto ▾
SoftKey2	Directory ▾			Auto ▾
SoftKey3	Forward ▾			Auto ▾
SoftKey4	Do Not Disturb ▾			Auto ▾

Scenario 2

Name

Default Scenario

Add To Scan List Enabled ▾

Key	Type	Value	Label	Account
SoftKey1	BLF ▾			Account 1 ▾
SoftKey2	BLF ▾			Account 1 ▾
SoftKey3	BLF ▾			Account 1 ▾
SoftKey4	BLF ▾			Account 1 ▾

4.4. Call Features

In this part, we will introduce the following content:

- [Call Forward](#)
- [Call Waiting](#)
- [Auto Answer](#)
- [DND](#)
- [DSS Keys](#)
- [Key as send](#)
- [Hotline](#)

ATCOM TECHNOLOGY CO., LIMITED www.atcom.cn 30

- [Anonymous Calls](#)

4.4.1. Call Forward

“Call Forward” includes “Always Forward”, “Busy Forward”, “No Answer Forward”.



“Always Forward” has the highest priority, and “Busy Forward” has the same priority as “No Answer Forward”, that means once the function of “Always Forward” is activated, other call forward features will be unavailable.

Any type of Call forward feature is activated, the Icon  will be indicated on the LCD Display.

Always Forward

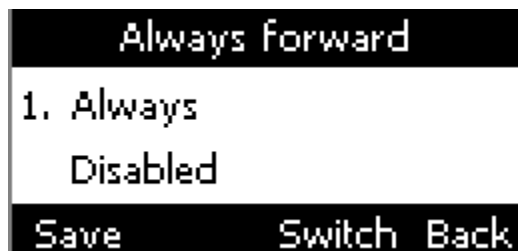
All incoming calls will be forwarded to target phone number once the “**Always Forward**” activated, setup this feature as follow and please move the navigation to check more:





Item	Operation	Description
Always	Press the key   or the soft key “ Switch ” to setup	Switch on or Switch off the feature. “ Enable ” mean this feature is enabled, “ Disable ” mean this feature is disabled.
Forward to	The Number key, “*”key, and “#”are permitted to be input.	Setup the target phone number which all incoming calls transferred to
On Code	The Number key, “*” key, and “#”are permitted to be input.	The feature code to enable all incoming calls forward, the phone will send the feature code directly to open all incoming calls forward
Off Code	The Number key, “*” key, and “#”are permitted to be input.	The feature code to disable all incoming calls forward, the phone will send the feature code to close all incoming calls

		forward directly
--	--	------------------

Busy Forward

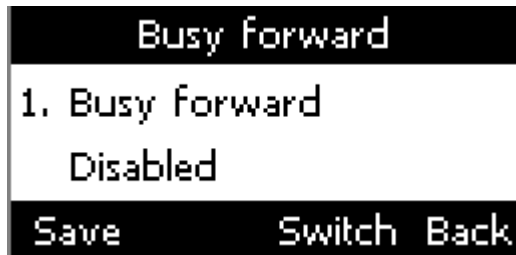
It means the phone is busy once the phone is not at standby mode. Setup this feature as below:





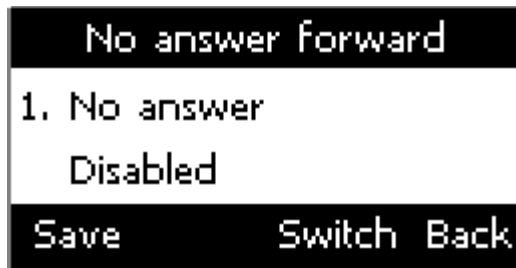

Item	Operation	Description
Busy	Press the key   or softkey "Switch" to setup	Switch on or Switch off the feature. "Enable" mean this feature is enabled, "Disable" mean this feature is disabled.
Forward to	The Number key, "*" key, and "#" are permitted to be input.	Setup the target phone number which all incoming calls transferred to
On Code	The Number key, "*" key, and "#" are permitted to be input.	The feature code to enable busy calls forward, the phone will send the feature code directly to open busy call forward
Off Code	The Number key, "*" key, and "#" are permitted to be input.	The feature code to disable busy calls forward, the phone will send the feature code directly to close busy call forward

No Answer Forward

All incoming calls will be forwarded after time out, once the feature of "No Answer Forward" is activated. Setup this feature as below, and please move the navigation key to check more:



Item	Operation	Description
No Answer	Press the key   or softkey " Switch " to setup	Switch on or Switch off the feature. "On" mean this feature is activated, "Off" mean this feature is unactivated .
Forward to	The Number key, "*" key, and "#" are permitted to be input.	Setup the target phone number which all incoming calls transferred to
After Ring Time	Press the key   or softkey " Switch " to setup	Setup timer for no answer status. All incoming calls will be forwarded after time out once Call forward when no answer activated.
On Code	The Number key, "*" key, and "#" are permitted to be input.	The feature code to enable no answer call forward, the phone will send the feature code directly to open all incoming calls forward
Off Code	The Number key, "*" key, and "#" are permitted to be input.	The feature code to disable all incoming calls forward, the phone will send the feature code directly to close all incoming calls forward

Setup Call Forward Via Web

Set Call Forward via web: **Phone**→**Forward&DND**→**Call Forward**

User can choose two forward mode:

1. Phone

If choose Phone mode, after configure call forward feature, it is used for all the phone accounts.

2. Custom

If choose custom mode, user can configure each or all accounts call forward feature, and this is our default mode.





Notes: after enable the emergency feature, you can input the **Authorized accounts** that it could not effective by the call forward feature.

atcom		Basic	Account	Network	DSS Keys	Phone	Contacts
Forward&DND							
Preferences							
Features							
Upgrade							
Auto Provision							
Configuration							
Remote Control							
Action URL							
Power LED							
Tones							
SMS							
Dial Plan							
Voice							
Phone Lock							
Call Forward							
Emergency		Enabled ▾					
Authorized Numbers		<input type="text"/>					
Mode		<input type="radio"/> Phone <input checked="" type="radio"/> Custom					
Account		151 ▾					
Always		Off ▾					
Target		<input type="text"/>				i	
On Code		<input type="text"/>				i	
Off Code		<input type="text"/>				i	
When Busy		Off ▾					
Target		<input type="text"/>				i	
On Code		<input type="text"/>				i	
Off Code		<input type="text"/>				i	
When No Answer		Off ▾					
After Ring Time (s)		12 ▾				i	
Target		<input type="text"/>				i	
On Code		<input type="text"/>				i	
Off Code		<input type="text"/>				i	

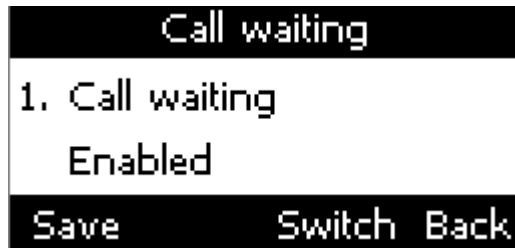
4.4.2. Call Waiting

The feature of "Call Waiting" is available by default. If switch off this feature, whatever multiple SIP accounts had been registered successfully, only one single active calling is permitted (for example Dialing, Ringing, Calling, Holding).



Item	Operation	Description
Call Waiting	Press the key   or softkey " Switch " to setup	Switch on or Switch off the feature. " Enable " mean this feature is enabled, " Disable " mean this feature is disabled.
Call Waiting Tone	Press the key   or softkey " Switch " to setup	Switch on or Switch off the prompt playing. " Enable " mean this feature is enabled, " Disable " mean this feature is disabled .

Setup call waiting via web: "Phone" → "Feature" → "General information" → "Call Waiting".

Setup call waiting Tone via web: "Phone" → "Feature" → "Audio Settings" → "Call Waiting Tone".

4.4.3. Auto Answer

The feature of "Auto Answer" is switched off by default. All incoming calls will be answered automatically when the phone is standby once "Auto Answer" is activated. "Auto Answer" when the phone is under "on Calling" status.

Please move the navigation key to check more:

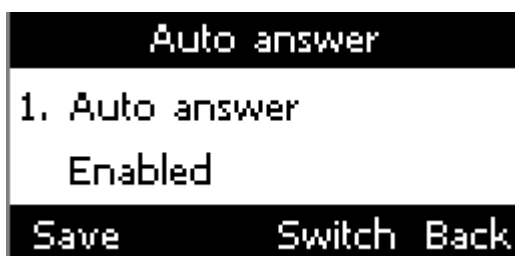

The Icon  will be indicated once "Auto Answer" is available.

Setup "Auto Answer" via Web: **"Phone" → "Feature" → "General information" → "Auto Answer"**

4.4.4. DSS Keys

The programmable keys include Line keys, Memory keys (aside the BLF LCD Display), Programmable keys and Soft keys on Standby UI.

Press the memory key for 2 seconds, it is able to modify the feature of each programmable key.

All programmable keys has been classified as "N/A", "Line Key", "BLF", "Key event", "Speed dial", "Intercom"

And the "Key Event" has been classified as "Conference", "Hold" "DND", "Redial", "Call return", "Pickup", "Call Park", "DTMF", "Directory".

Comments:



N/A

N/A means this key is not permitted to be set as a programmable key.

Line key

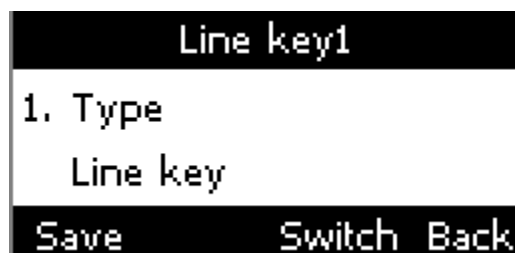
Display the account information, press it for making a call, answering incoming calls, call hold and resume.





Item	Description
Account ID	To display the account ID, press the soft key " Switch " or  、  to modify, the optional value is Account 1 to 6.
Account name	Display the account name of each account ID, non-modifiable.
SIP Server	The SIP server of each Account ID, non-modifiable. If not set any value for some account ID, the account name will be null.

BLF

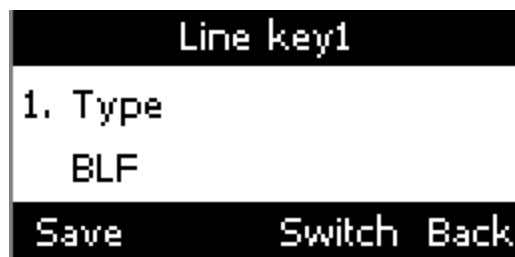
Indicate the status of monitored account. Once set the BLF key with Pickup feature, user is able to answer the incoming call to the monitored account by pressing the corresponding BLF key. If the monitored account is idle, press the corresponding BLF key for speed dial.



Item	Description
Account ID	To display the account ID, press the soft key " Switch " or  、  to modify, the optional value is Account 1 to 6.
Label	To identify this key on LED, for example "blf"
Value	The phone number will be monitored by this key. For example, if user want to monitor the phone number (5003), please set "6070" here.
Extension	This code must be configured for pickup, and this code provide by Server. If the code is not matched by Server, the feature of pickup will not work.

Conference

The 3-way conference will be setup by pressing the key "Conf" while on calling. For more info, please refer to [Chapter 3.8](#).

The configuration item **Label** is a name to identify the key on LED, can be set as "conference".

Hold

The same feature as the key . For more info, please refer to [Chapter 3.5](#).

The configuration item **Label** is a name to identify the key on LED, can be set as "hold".

DND

Press this key will switch on or switch off the feature of "DND".

The configuration item **Label** is a name to identify the key on LED, can be set as "DND".

Redial

The same feature as the key .

The configuration item **Label** is a name to identify the key on LED, can be set as "redial".

Call return

Automatically dial the latest phone number in history.

The configuration item **Label** is a name to identify the key on LED, can be set as "return".

Call Pickup

Press this key to pick up if new incoming call to the monitored phone number.

Item	Description
Value	The phone number monitored for pickup
Label	D2X cannot definition label

Reminding: This code must be set for pickup, and this code can be set via Web only.

Set the Pickup code as follow:

Set the pickup code for one single Account: **Account**→**Advanced**→**Select an account to be configured**→**Directed Call Pickup Code**.

Set the pickup code for all Accounts: **Phone**→**Features**→**Call Pickup**→**Direct Call Pickup**. **Direct Call Pickup Code (Direct Call Pickup should be set as Enable)** .

Call Park

Press this key while on calling, the phone will dial the specified phone number, user will receive a code on the phone prompt, and then press the soft key "Transfer", the current calling will be parked successfully. At this moment, user is able to continue the parked calling with any other phones which registered on the same SIP server by dialing the code which user have received.

Item	Description
Value	The code for pickup the parked call and it is provided by SIP server.
Label	D2X cannot definition label

DTMF

Press this key while on calling, the phone will send the configured "**Value**" automatically.

Item	Description
Value	The value sent to remote end while on calling.
Label	D2X cannot definition label

Directory

Press this key to access Directory.

Speed Dial

Press this key while standby state, the specified target phone number will be dial from the specified account.

Item	Description
Value	The target phone number for speed dial
Label	D2X cannot definition label

Intercom

Press this key when the phone is idle, the phone will dial the specified "Value", and there mote end will answer the call automatically.

Note: This feature is supported by specified servers only.

Item	Description
Value	The target phone number for Intercom
Label	D2X cannot definition label

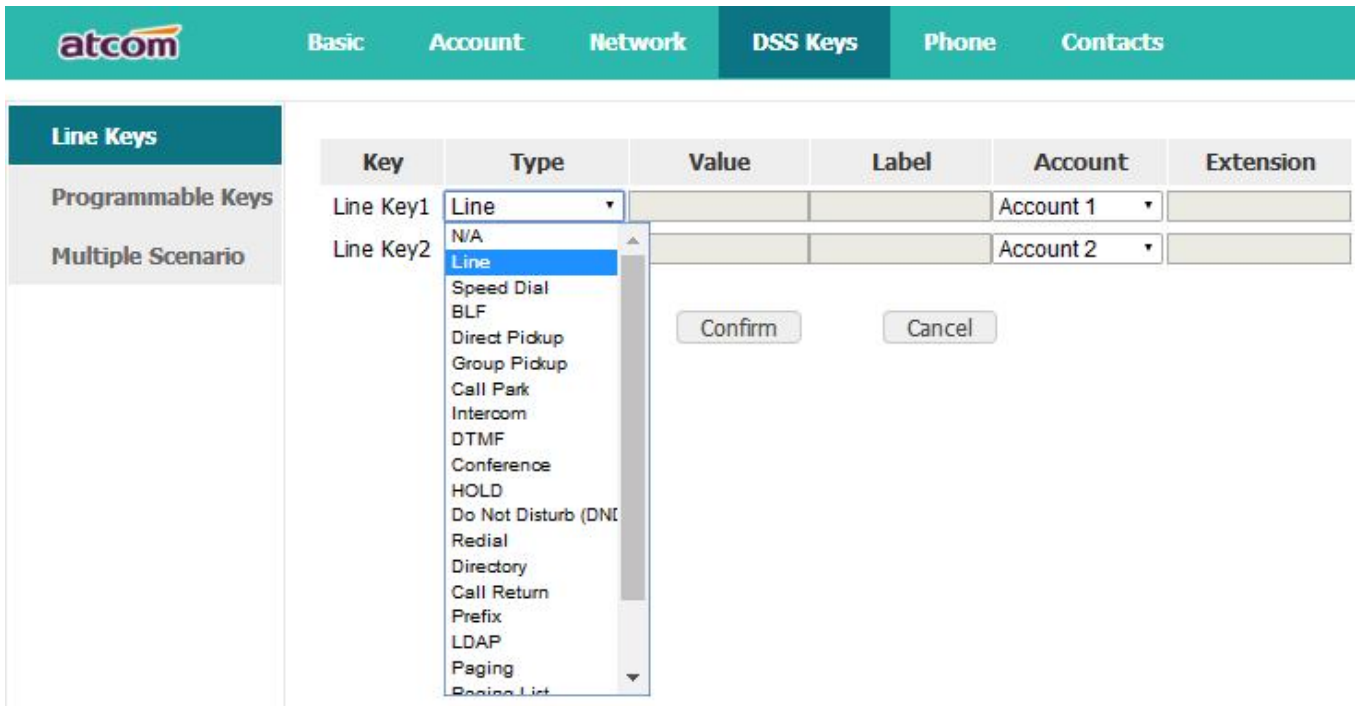

4.4.5. DND

The phone enabled the DND(Do not disturb) feature, the phone reject all the incoming call, and the phone would show icon. IP phone receive an incoming invite message and responding 480 temporarily unavailable.

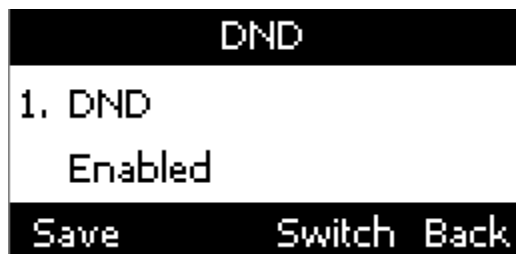

Item	Operation	Description
DND	Press the key or softkey "Switch" to setup	Switch on or Switch off the feature. "Enable" mean this feature is enabled, "Disable" mean this feature is disabled.
On Code	The Number key, "*" key, and "#" are permitted to be input.	The feature code to enable busy calls forward, the phone will send the feature code directly to open busy call forward
Off Code	The Number key, "*" key, and "#" are permitted to be input.	The feature code to disable busy calls forward, the phone will send the feature code directly to close busy call forward

Setup DND feature Via Web

Set DND via web: **Phone**→**Forward&DND**→**DND**

User can choose DND mode:













1. **Phone**

If choose Phone mode, once enable the DND feature, it is used for all the phone accounts.

2. **Custom**

If choose custom mode, user can configure each or all accounts call forward feature, and this is our default mode.

Notes: after enable the emergency feature, you can input the **Authorized accounts** that it could not effective by the DND.

atcom		Basic	Account	Network	DSS Keys	Phone	Contacts
Forward&DND							
Preferences							
Features							
Upgrade							
Auto Provision							
Configuration							
Remote Control							
Action URL							
Power LED							
Tones							
SMS							
Dial Plan							
Voice							
Phone Lock							
Ring							
TR069							
Security							
Debug							
Trusted Certificates							
Server Certificates							
		Call Forward					
		Emergency	Enabled ▾				
		Authorized Numbers	<input type="text"/>				
		Mode	<input type="radio"/> Phone <input checked="" type="radio"/> Custom				
		Account	151 ▾				
		Always	Off ▾				
		Target	<input type="text"/>				
		On Code	<input type="text"/>				
		Off Code	<input type="text"/>				
		When Busy	Off ▾				
		Target	<input type="text"/>				
		On Code	<input type="text"/>				
		Off Code	<input type="text"/>				
		When No Answer	Off ▾				
		After Ring Time (s)	12 ▾				
		Target	<input type="text"/>				
		On Code	<input type="text"/>				
		Off Code	<input type="text"/>				
		DND					
		Emergency	Enabled ▾				
		Authorized Numbers	<input type="text"/>				
		Mode	<input type="radio"/> Phone <input checked="" type="radio"/> Custom				
		Account	151 ▾				
		DND Status	<input type="radio"/> On <input checked="" type="radio"/> Off				
		DND On Code	<input type="text"/>				
		DND Off Code	<input type="text"/>				
				Confirm		Cancel	

4.4.5. Key as Send

The key "Key as Send" has the same function as the soft key "Dial".

Reminding: This key is not available while pre-dial. It's the only way to press the soft key "Dial" or pickup the handset to finish pre-dial.

The default value is “#”, and it could be set as “*”. If set the value as “disable”, it means the function “Key as Send” is forbidden.

Set “Key as Send” via web : **Phone→Features→General Information→Key As Send.**

4.4.6. Hotline

Once “Hotline” has been set, the phone will automatically dial the hotline via the 1st available line if the phone stay in the standby status exceed the specified waiting time and there is no input (or input something and then all deleted).

Hotline	
1. Hotline	10000
2. Hotline timeout	4

Save 123 Delete Back

Item	Description
Hotline	Set up the hotline number, the value is null by default.
Hotline timeout	Set up the timeout for hotline activation, 4 seconds by default.

Set hotline via web: **Phone→Features→General Information→Hotline.**

Set Hotline Time-out(secs) via web: **Phone→Features→General Information→Hotline Time-out(secs).**

4.4.7. Anonymous Call





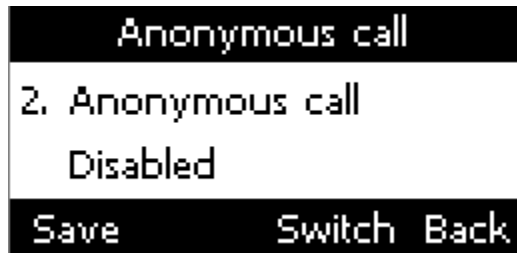

This function includes making anonymous calls and blocking all anonymous calls.

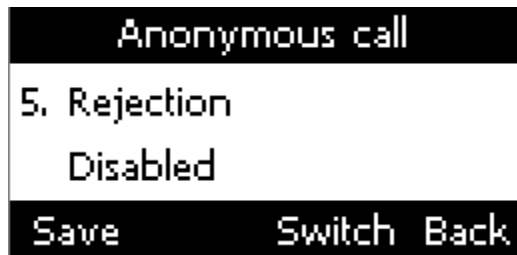
If switch on the feature “Anonymous call”, all outgoing calls will be displayed as anonymous call in the other side.



If switch on the feature "Rejection", all incoming anonymous calls will be blocked automatically.



Item	Operation	Description
Accounts	press the soft key "Switch" or   to modify,	Select the Account for anonymous call.
Anonymous Call	press the soft key "Switch" or   to modify,	Switch on/off the feature of making anonymous calls.
Call On Code	The Number key, "*" key, and "#" are permitted to be input.	Set the feature code to turning on anonymous call, the phone enables anonymous call by sending the feature code to the server
Call Off Code	The Number key, "*" key, and "#" are permitted to be input.	Set the feature code to turning off anonymous call, the phone disables anonymous call by sending the feature code to the server
Rejection	press the soft key "Switch" or   to modify	Switch on/off the feature of blocking anonymous calls.
Reject On Code	The Number key, "*" key, and "#" are permitted to be input.	Set the feature code to turning on anonymous call rejection, the phone enables anonymous call rejection by sending the feature

		code to the server
Reject Off Code	The Number key, “*” key, and “#” are permitted to be input.	Set the feature code to turning off anonymous call rejection, the phone disables anonymous call rejection by sending the feature code to the server

Set Anonymous Call via web: **Account**→**Basic**→**Select the Account**→**Anonymous Call**.

Set Anonymous Call Rejection via web: **Account**→**Basic**→**Select the Account**→**Anonymous Call Rejection**.

4.5. Contacts

The content of Directory includes local phonebook and blacklist. Enter Directory as follow,

1. Press the soft key “Contacts” when the phone is standby
2. Press the navigation key 
3. Press the menu softkey, and then select “Contacts”

Configure the “Contacts” via Web:

atcom
Basic
Account
Network
DSS Keys
Phone
Contacts

Contacts
 Remote Phone Book
 LDAP
 Phone Call Info

Contacts
Black List

Index	Name	Office Number	Mobile Number	Other Number	<input type="checkbox"/>
Save Delete Move to Black List					

Contacts

* Name

Office Number

Mobile Number

Other Number

Ring

Add Edit Search

Import and Export Local Contacts

Import Local Contacts
Browse...

Import Export

All operations on Directory via Web will be not active until click "Save". When too much item existed in the Directory, it will be an easy way to search by keyword about name, Office Number, Mobile Number or other Number. The exactly matched item will be listed, otherwise you will be prompted "Not find the specified contact".

Local Contacts



Name and phone number are permitted to be saved into the local phonebook, and up to 1000 items. It's able to add new group, new contact, edit or delete exist contact or dial, also move the item to blacklist.

Make calls from directory

Path to set on the phone: Press **Menu** key→**Contacts**→**Local Contacts**→**All contact**→**Select the record**→**Dial**。



If only one phone number saved with the selected contact person, the phone number will be dialed while calling the contact person.

If multiple phone numbers saved with the selected contact person, user must select one of the phone numbers for dialing while calling the contact person.

Add new contact

Path to add new contact on the phone: **Press Menu key**→**Contacts**→**Local Contacts**→**All contact**→**Add**.



Item	Operation	Description
Name	Input by number keys, "*" or "#" key, change the input-method via pressing the soft key "abc"	It's used to identify different phone numbers. Any reduplicated names are not permitted in the contacts.
Office	Input by number keys, "*" or "#" key, change the input-method via pressing the soft key "abc"	You can save three numbers at most. While calling a contact person in contacts, the phone will redirect to the page that to select one number to dial when multiple numbers are saved for one contact record
Mobile		
Other		
Ring	Press the key   or the soft key "Switch" to modify the account ID.	It's used to bundle each item with the corresponding ringtone, and the optional value is "Auto" or "Ringtone 1" to "Ringtone 10". "Auto" means the default ringtone will be played if new incoming call happened, otherwise the selected ringtone will be played.

Add new contact via web: **Contacts**→ **Contacts**→**Input messages**→**Add**→**Save**.

Edit the contact

User must re-edit the contact item while updating one item of local phonebook.

Path to edit the contact on the phone: **Press Menu key**→**Contacts**→**Local Contacts**→**All contacts**→ **Select the item to edit**→**Option**→**Edit**→**OK**.

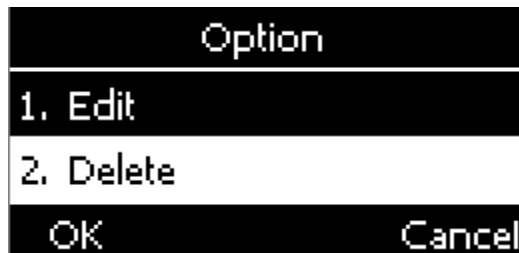

Edit the contact item via Web: **Contacts**→ **Contacts**→**click on the item to edit**→**modify messages**→**Click "Edit"**→**Click "Save"**.

Delete the contact

Path to delete the contact on the phone: **Press Menu key**→**Contacts**→**Local Contacts**→**All contacts**→**Select the item to delete**→**Option**→**Delete**→ **OK**→**OK**.

Press the soft key **"Cancel"** at the Warning UI to stop deleting.

Delete the contact item via web: **Contacts**→ **Contacts**→**Select the item to delete**→**Click on "Delete"**→**Click on "Save"**.

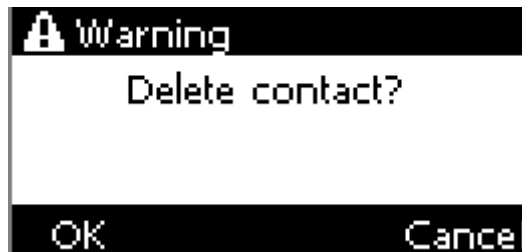

Move to blacklist

Path to move to blacklist on the phone: **Press Menu key**→**Contacts**→**Local Contacts**→**All contacts**→**Select the item to move**→**Option** →**Move to Blacklist** → **OK**→**OK**.

Press the soft key **"Cancel"** at the Warning UI to stop this operation.

Move the contact item to blacklist via web : **Contacts**→ **Contacts**→**Select the item to move to blacklist**→**Click on "Move to black List"**→**Click on "Save"**。

Blacklist

The purpose of blacklist's feature is to block the phone number inside blacklist to call the host phone number, but it's available for the hosted phone number to call any phone number in the black list.

The most operation of blacklist is the same as local phonebook except for the feature "Move to Contacts", it means moving an item of blacklist to local phonebook to resume the phone number to dial the host phone number normally.



Remote phonebook

The screenshot shows the "atcom" web interface with a teal header containing navigation tabs: Basic, Account, Network, DSS Keys, Phone, and Contacts. The "Contacts" tab is active. On the left, a sidebar menu includes "Contacts", "Remote Phone Book" (highlighted), "LDAP", and "Phone Call Info". The main content area displays a table for Remote Phone Book configuration:

Index	Remote URL	Display Name
1	<input type="text"/>	<input type="text"/>
2	<input type="text"/>	<input type="text"/>
3	<input type="text"/>	<input type="text"/>
4	<input type="text"/>	<input type="text"/>
5	<input type="text"/>	<input type="text"/>















Below the table is a "Search Settings" section with two rows:

- Search Remote Phonebook name *i*
- Search Flash Time *i*

At the bottom of the settings section are "Confirm" and "Cancel" buttons.

1. Remote URL: Set a remote phonebook download path. Support the TFTP,FTP,HTTP and HTTPs server.
2. Display name: Set a display name on the phone.
3. Search Remote Phonebook name: Select "Yes" or "No" to enable or disable search remote phonebook name.
4. Search Flash Time: Set the search flash time. Defaults to 120.

LDAP

LDAP 	
Enable LDAP	<input type="text" value="Disable"/>
LDAP Name Filter	<input type="text"/> 
LDAP Number Filter	<input type="text"/> 
Server Address	<input type="text"/> Port <input type="text" value="389"/> 
Base	<input type="text"/> 
Username	<input type="text"/> 
Password	<input type="text"/> 
Max Hits	<input type="text" value="50"/>  (1~32000)
LDAP Name Attributes	<input type="text"/> 
LDAP Number Attributes	<input type="text"/> 
LDAP Display Name	<input type="text"/> 
Protocol	<input type="text" value="Version 3"/>
LDAP Sorting Results	<input type="text" value="Disable"/> 
LDAP Lookup For Incoming Call	<input type="text" value="Disable"/> 
LDAP Lookup For dialing	<input type="text" value="Disable"/> 

1. Enable LDAP: Select "Yes" or "No" to enable or disable LDAP.
2. LDAP Name Filter: Set the name of the LDAP search attributes.

3. LDAP Number Filter: Set the number of the LDAP search attributes.
4. Server Address: Set the LDAP server domain name or IP address.
5. Port: Set the LDAP server port number. Default to 389.
6. Base: Set the LDAP search base.
7. Username: Set the LDAP server username.
8. Password: Set the LDAP server password.
9. MD2X(w) Hits(1~32000): Set the MD2X(w)imum number of search results from the LDAP server.
10. LDAP Name Attributes: Set the name of the attributes returned from the server.
11. LDAP Number Attributes: Set the number of the attributes returned from the server.
12. LDAP Display Name: The contact record the name of the displayed on the LCD.
13. Protocol: Set the phone to support LDAP protocol version. Defaults to version 3.
14. LDAP Sorting Results: Set the phone to sort the search results.
15. LDAP Lookup For Incoming Call: Set the phone for LDAP search when incoming call.
16. LDAP Lookup For dialing: Set the phone for LDAP search when dialing,

4.6. History

It includes the dialed, answered, missed and transferred items, MD2X(w)imum 400 items.

User is able to review or delete any item of the history on the phone. And enter "History" in below ways:

1. Press the key 
2. Press the Menu key, then select "History"
3. Press the soft key "History" while phone is under standby status

When any one the above of operations is done, details info of all recent history will be listed on LCD display, include the type of each item, the name of contact person, date and time.

Also, user is able to check the detail info of call history via Web, but only review operation is allowed while accessing via web.

atcom																																			
Basic		Account		Network																															
DSS Keys		Phone		Contacts																															
<table border="1"> <thead> <tr> <th colspan="6">atcom</th> </tr> <tr> <th colspan="6">Contacts</th> </tr> <tr> <th colspan="6">Remote Phone Book</th> </tr> <tr> <th colspan="6">LDAP</th> </tr> <tr> <th colspan="6">Phone Call Info</th> </tr> </thead></table>						atcom						Contacts						Remote Phone Book						LDAP						Phone Call Info					
atcom																																			
Contacts																																			
Remote Phone Book																																			
LDAP																																			
Phone Call Info																																			

Dialed List		Missed List		Received List	
Forwarded List					
Index	Datetime	Duration	Local Identity	Name	Tel Number
1	2017/5/5 10:03	00:00:02	115@172.16.0.237:5060	114	114@172.16.0.237
2	2017/5/5 09:46	00:00:36	115@172.16.0.237:5060	120	120@172.16.0.237

Make calls from history

Path to make calls from history on the phone: **Enter history UI→Select the item to dial→Dial.**

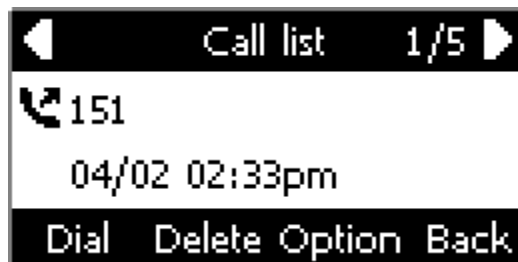

Delete one item from history

Path to delete one item from history on the phone: **Enter history UI→Select the item to delete→Delete.**

Check the details of history

Path to check the details of history on the phone: **Enter history UI→Select the item to check→Option→Detail→Press  or "OK".**

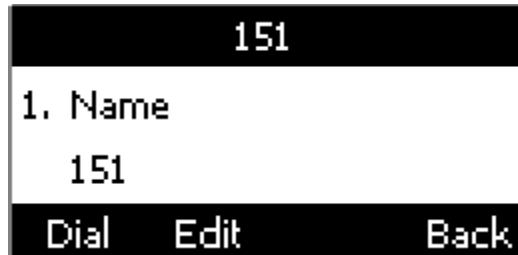

Add to Contact



1. Enter "Call History"→Select the target item→Option→add to Contact→Press the key  or soft key "Confirm".

At this moment an "edit" page will be popped up.

please move the navigation key to check more



The item of "Office", "Mobile" and "Other" are able to be switched over between "Old Number" and current number. If the being operated item had been saved already in the contacts, "Old Number" will be the previous value, otherwise "Old Number" will be null. The UI page of "Add to Blacklist" is the same as above.

2. **Modify the contact name, phone number and ringtone.**
3. **Press the key  or soft key "Saved" to save the modification, press the key  or soft key "Cancel" to Cancel the modification.**

Add to Blacklist

For more info about this operation, please refer to [Add to Contact](#).

Delete all History's records

Path to delete all history's records on the phone: **Enter History UI**→**Option**→**Delete all**→

Press  or "OK".

4.7. Message

4.7.1. Voice Mail

User will benefit from the feature of voicemail when they're not available to answer an incoming call or missed some incoming calls. However this feature must be supported by Server. Voicemail must be set up before using it.

Set the voicemail via Web: **Account**→**Basic**→**Select an account to configure**→**Voice Mail**.



Sometimes the voicemail push can't be reached in time, because the configuration problem with Server, you must configure some related parameter via Web to make the phone automatically send its request to Server for getting voicemail info.

Set "Subscribe for MWI" via web: **Account**→**Advanced**→**Subscribe for MWI**.

Set "MWI Subscription Period(secs)" via web: **Account**→**Advanced**→**MWI Subscription Period(secs)**.

Set Voice Mail



There are 3 different methods to set up the voicemail,

1. Press the key  after factory set
2. Press the key  for a while
3. Press the Menu key→Select "Message"→Setup Voicemail



View Voice Mail

User is able to check voicemail in below ways:

1. **Setup voicemail number**→**Press the key** 
2. **Press the key** →**Select "Message"→"View Voicemail"**

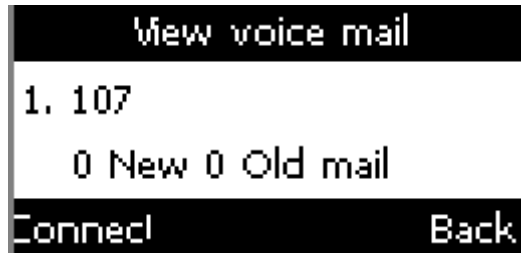

Select the account with "N new N old mail", and press the soft key "Connect", the corresponding voicemail will be connected.

Select the account with "Unregistered", and press the soft key "Connect", the setting page of Voicemail will be popped up.

4.8. Settings

Basic settings and Advanced settings will be introduces in this part,

Basic Settings



1. Language

D2X supports multiple language, to modify the language, please press the **Menu** key→**Setting**→**Basic setting**→**Language**→**Select the target language and press the soft key "Save"**.

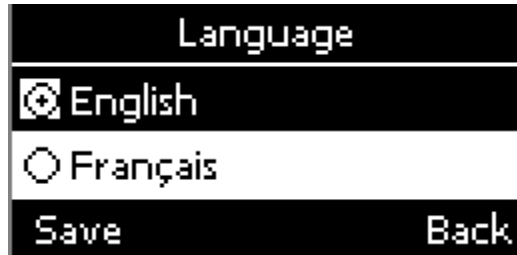

Set language via web: There is a drop-down box at the top left corner of webpage, choice one kind of language and click, the language will take effect immediately.

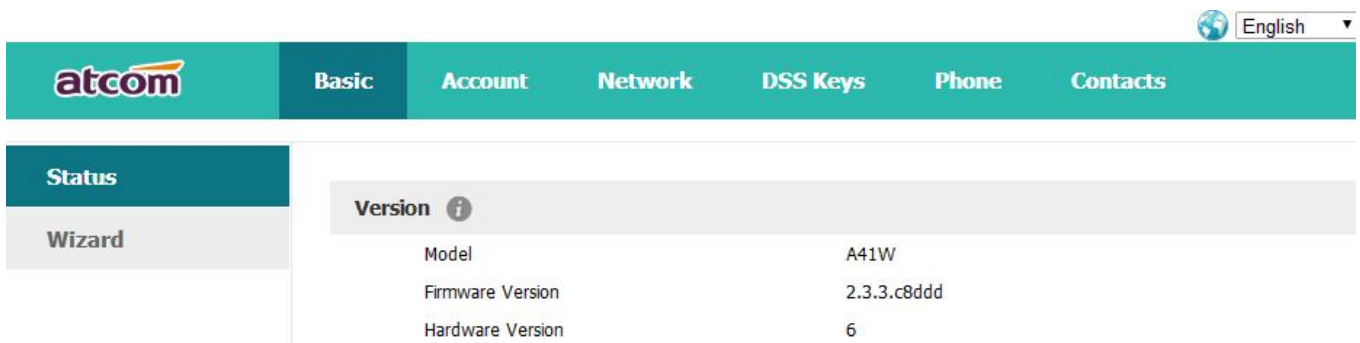

2. Time &Date





Time & Date will be displayed at the standby page of D2X, and these info will be related with all process of IP phone. "Time & Date" can be gained by NTP Server automatically or set manually.

NTP Setting



Path to set on the phone: **Press the Menu key→Settings→Basic Settings→Time & Date→NTP Settings.**

Please move the navigation key to check more:



Item	Operation	Description
Time Zone	Press the key  .  or soft key "Switch" to modify it.	Select the correct Time Zone for the IP phone.
NTP Server	Key in the IP address of domain name by the number keys,"*","#"	Specify the NTP Server
Secondary NTP Server	Key in the IP address of domain name by the number keys,"*","#"	Specify the standby NTP Server
Daylight-Saving Time	Press the key  .  or soft key "Switch" to modify it.	Optional: "Off", "Auto" or "Manual". And "Manual" mean user must set this via web.

Set NTP via Web: **Phone**→**Preference**.

Time Zone	<input type="text" value="+8 China(Beijing)"/>	
Primary NTP Server	<input type="text" value="pool.ntp.org"/>	
Secondary NTP Server	<input type="text" value="time.windows.com"/>	
Update Interval(secs)	<input type="text" value="1000"/>	
daylight	<input type="text" value="Disable"/>	
Fixed Type	<input checked="" type="radio"/> By Date <input type="radio"/> By Week	
Start Month	<input type="text" value="January"/>	
Start Date	<input type="text" value="1"/>	
Start Hour of Day	<input type="text" value="0"/>	
Start Day of Week	<input type="text" value="Sunday"/>	
Start Week of Month	<input type="text" value="First In Month"/>	
Stop Month	<input type="text" value="January"/>	
Stop Date	<input type="text" value="1"/>	
Stop Hour of Day	<input type="text" value="0"/>	
Stop Day of Week	<input type="text" value="Sunday"/>	
Stop Week of Month	<input type="text" value="First In Month"/>	
Offset(minutes)	<input type="text" value="0"/>	

Item	Operation	Description
Time Zone	Click drop-down box to select	Set a time zone matches condition
Primary NTP Server	Manual input	The primary NTP server that provide time and date
Secondary NTP Server	Manual input	The secondary NTP server that provide time and date
Update Interval(secs)	Manual input	The interval that the phone gains time and date from NTP server
Daylight	Click drop-down box to select	A switch to control the status that whether to enable the daylight or not
Fixed Type	Radio content	Daylight fixed type, only the specified items are configurable
Start Month	Click drop-down box to select	The month that the daylight rule begins taking effect
Start Date	Manual input	The day that the daylight rule begins taking effect
Start Hour of Day	Manual input	The hour of day that the daylight rule begins taking effect
Start Day of Week	Click drop-down box to select	The day of week that the daylight rule begins taking effect
Start Week of Month	Click drop-down box to select	The week of month that the daylight rule begins taking effect
Stop Month	Click drop-down box to select	The month that the daylight rule stops taking effect
Stop Date	Manual input	The day that the daylight rule stops taking effect
Stop Hour of Day	Manual input	The hour of day that the daylight rule stops taking effect
Stop Day of Week	Click drop-down box to select	The day of week that the daylight rule stops taking effect
Stop Week of Month	Click drop-down box to select	The week of month that the daylight rule stops taking effect

Offset(minutes)	Manual input	The offset time that daylight rule takes effect
------------------------	--------------	---

Manual Settings

Path to set on the phone: **Press the menu key→Settings→Basic Settings→Time & Date→Manual Settings.**

Please move the navigation key to check more:



Item	Operation	Description
Year	Key in "Year" with the number key, "*"and "#"	Date info
Month	Key in "Month" with the number key, "*"and "#"	
Day	Key in "Day" with the number key, "*"and "#"	
Hour	Key in "Hour" with the number key, "*"and "#"	Time info
Minute	Key in "Minute" with the number key, "*"and "#"	
Second	Key in "Second" with the number key, "*"and "#"	

Set the Time & Date manually via web: **Phone→Preference.**

Manual Time Disable

Date

Time

Item	Operation	Description
Manual Time	Click the drop-down box to select	A switch to control the status whether to enable the manual time or not
Date	Manual input, click "Generated Date" to gains date from the computer	Set date manually
Time	Manual input, click "Generated Time" to gains time from the computer	Set time manually

3. Time&Date Format

Path to set on the phone: **Press the Menu Softkey→Settings→Basic Settings→Time & Date Format.**

please move the navigation key to check more:

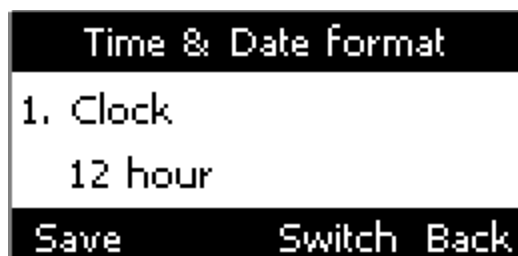

Item	Optional	Example of result
Clock	12 hour	03:30pm
	24 hour	15:30
Date	WWW MMM DD	TuesdayOct.16
	DD-MMM-YY	16-Oct.-16
	YYYY-MM-DD	2016-10-16
	DD/MM/YYYY	16/10/2016
	MM/DD/YY	10/16/16

	DD MMM YYYY	16,Oct.,2016
	WWW DD MMM	Tuesday,17,Oct.



Set the Time &Date Format via Web: **Phone**→**Preference**

4. Ringtones

5 different ringtones have been provided by D2X for selection. Path to set on the phone:

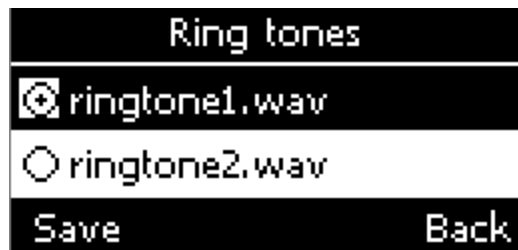
Press the Menu softkey→**Settings**→**Basic Settings**→**Ringtones**.



For the selected ringtone, there is a dot inside the circle. Press the key   to select other ringtone for playing.

Set ringtones via Web: **Account**→**Basic**→**Ring tones**.

5. Headset Memory Mode

Headset memory mode can be used to control the default device to make or answer calls. This function is disabled by default, which means the phone will communicate with others by hand-free when pre-dial or making calls from history or contacts, and so is the situation that pressing "Answer" soft key to accept an incoming call. Once this function is enabled, the phone will make or answer calls by headset. Long press  can change the status of the "Headset Memory Mode".

This function can be configured on the phone only: **Press the Menu key**→**Settings**→**Basic Settings**→**Headset Memory Mode**.

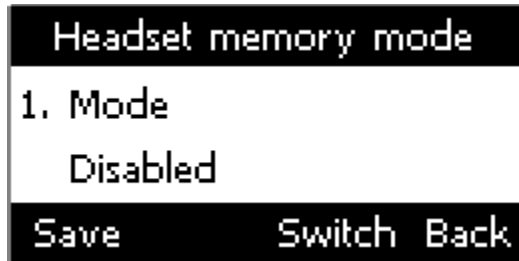

6. Phone Unlock PIN

Phone Unlock PIN: Unlock the phone locked conditions.

please move the navigation key to check more and press the cancel key to back the function,



Item	Operation	Description
Current PIN	Manual input	Input the phone current PIN, Default factory pin:123
New PIN	Manual input	Set the new PIN
Confirm PIN	Manual input	Confirm the new PIN

Advanced Settings

Password will be requested while accessing the page of "Advanced Settings". This password is the same as the user's("admin") to access.

1. Account

path to set the account info on phone: Press  → **Settings** → **Advanced Settings** → **Input password** → **Accounts**.

Account 1	
1. Activation	Enable
2. Label	
3. Display name	test118
4. Register name	
5. User name	118
6. Password	*****
Save	Switch
	Back

Item	Description
Activation	The status of account, the default is "Enable", if set this as "Disable", the account will be forbidden.
Label	It will show on the phone, can skip this item
Display Name	Parameter that in the SIP, if the SIP Server is supportable, this name will show on the phone of called
Register Name	The register ID, supplied by SIP Server, can skip this item
User Name	Account ID
Password	Password for account
SIP Server	The address that accounts needed to register from
Outbound Status	The status of Outbound Server, "off" by default
Outbound Proxy	IP address of Outbound Agency
Stun Status	The status of Stun Server, "off" by default
Stun Server	IP address of Stun Server

Configure account via web: **Account** → **Basic**

atcom		Basic	Account	Network	DSS Key	Phone	Contacts
Basic	Account		Account 1				
Codecs	Register Status	Register failed					
Advanced	Account Active	Enable					
	Label	<input type="text"/>					i
	Display Name	<input type="text"/>					i
	Register Name	<input type="text"/>					i
	* User Name	<input type="text"/>					i
	Password	<input type="text"/>					i
	* SIP Server	<input type="text"/>	Port	5060	i		
	Enable Outbound Proxy Server	Disable					i
	Outbound Proxy Server	<input type="text"/>	Port	5060	i		
	Transport	UDP					i
	NAT Traversal	Disable					i
	STUN Server	<input type="text"/>	Port	3478	i		

2. Set Password

The password for Advanced Settings also is used for Web access as the role "admin". Path to

set password on phone: Press  → **Settings** → **Advanced Settings** → **Input password** → **Set Password**.

Set password

1. Current PWD	<input style="width: 95%;" type="text"/>
2. New PWD	<input style="width: 95%;" type="text"/>
3. Confirm PWD	<input style="width: 95%;" type="text"/>

Save
abc
Delete
Back

Item	Description
Current PWD	The current password for web access as the role of "admin", it's "admin" by default.
New PWD	To set the new password, blank is acceptable.
Confirm PWD	Input the new password again, to confirm the new password.

Set password via Web: **Phone**→**Security**.

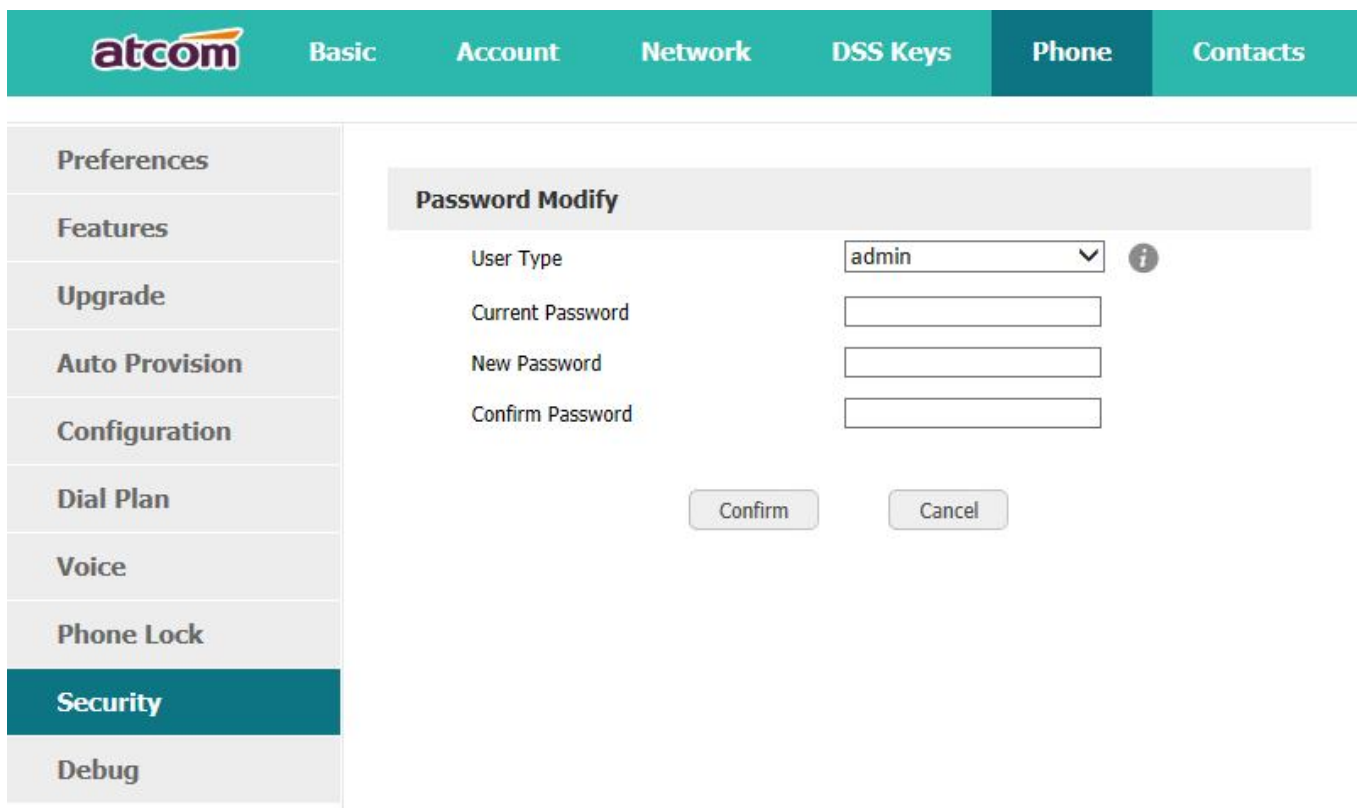

The screenshot shows the atcom web interface with the 'Phone' tab selected. The left sidebar contains a menu with 'Security' highlighted. The main content area displays the 'Password Modify' form with the following fields:

- User Type: dropdown menu with 'admin' selected and an information icon.
- Current Password: text input field.
- New Password: text input field.
- Confirm Password: text input field.

At the bottom of the form are 'Confirm' and 'Cancel' buttons.

3. Network

Path to set network parameters on phone: **Press**  → **Settings**→**Advanced Settings**→**Input the password**→**Network**.

please move the navigation key to check more:

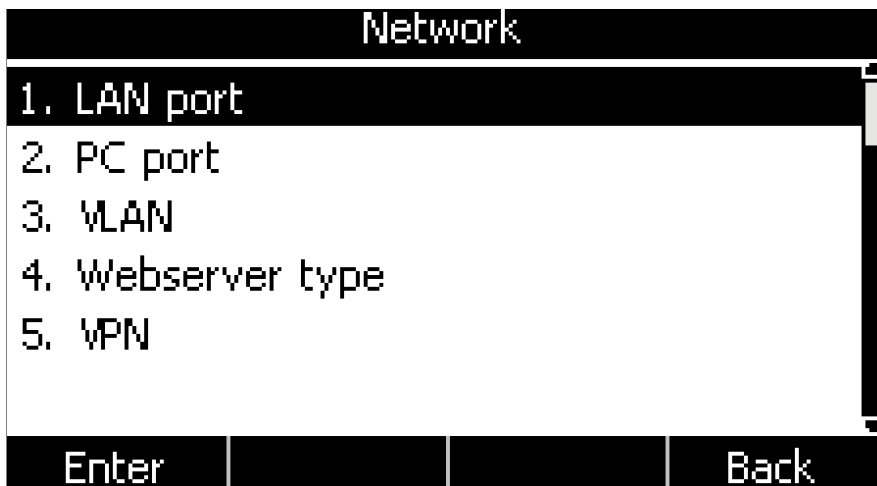

➤ LAN Port

Connect the phone with local network via LAN port, to gain IP address in 3 ways: DHCP, Static. Set the LAN port via Web: **Network**→**Basic**.

DHCP

The phone gains IP address via DHCP and Static DNS by default.

STATIC IP

If the phone gains IP address via Static IP, user must input the IP address info manually.

➤ PC Port

Only bridge mode support by PC port.

➤ VLAN

The feature of VLAN must be supported by network switch, and by default this feature it's not activated.

Set the VLAN via Web: **Network** →**Advanced**→**VLAN**.

➤ Webserver Type

Webserver type include HTTP and HTTPS, different access port will be required by different access type, user is able to confirm the port info at the webpage, HTTP & HTTPS are both permitted by default.

Set Webserver type via Web: **Network**→**Advanced**→**WebServer**→**Type**.

➤ VPN

D2X support the feature of Open VPN, and this feature must be supported by VPN Server.

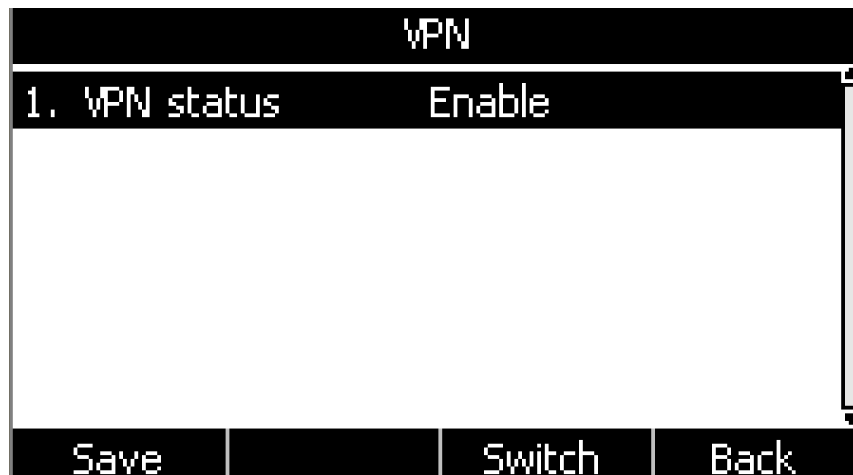

Set the VPN via Web: **Network** →**Advanced**→**VPN**.



➤ LLDP

D2X supports LLDP, and enable in default. If the phone is connected to a switch and using LLDP, the switch would notifies IP phone of VLAN information.

Set the LLDP via Web: **Network** →**Advanced**→**LLDP**

atcom		Basic	Account	Network	DSS Keys	Phone	Contacts
Basic							
Wi-Fi							
Advanced							

LLDP <i>i</i>	
Active	Enable ▾
Packet Interval(1~3600s)	60

CDP <i>i</i>	
Active	Enable ▾
Packet Interval(1~3600s)	60

➤ 802.1X

IEEE 802.1X authentication is an IEEE standard for Port-based Network Access Control(PNAC), part of the IEEE 802.1 group of networking protocols. It offers an authentication mechanism for devices to connect to a LAN or WLAN.

It supports protocol EAP-MD5, EAP-TLS, EAP-PEAP/MSCHAPv2, EAP-TTLS/EAP-MSCHAPv2, EAP-PEAP/GTC and EAP-TTLS/EAP-GTC for 802.1X authentication.

Set the 802.1X via the webpage: **Network** → **Advanced** → **802.1X**

802.1X <i>i</i>	
Mode	Disable ▾
Anonymous Identity	<input type="text"/>
Identity	<input type="text"/>
Md5 Password	<input type="text"/>
CA Certificates	<input type="text"/> Browse...
	Import
Device Certificates	<input type="text"/> Browse...
	Import

4. Keypad Lock

It support enable or disable the keypad lock feature, if enable, **the default password is 123**:

Please move the navigation key to check more



Keypad lock	
1. Lock enable	Disabled
2. Lock type	Menu key
3. Lock timeout	10
4. Unlock before	Disabled

Save Switch Back

Keypad lock via webpage: **phone**→**Phone lock**

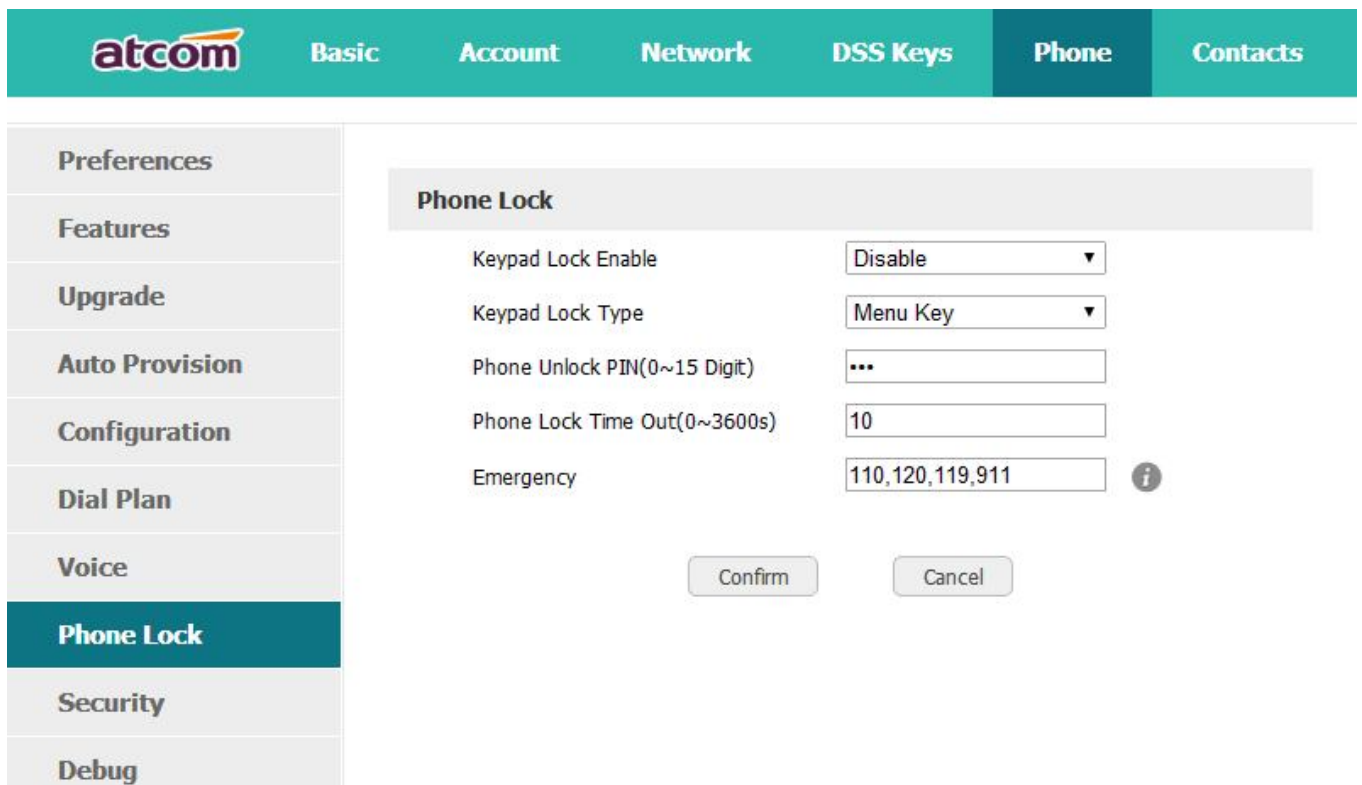

atcom Basic Account Network DSS Keys Phone Contacts

Preferences
Features
Upgrade
Auto Provision
Configuration
Dial Plan
Voice
Phone Lock
Security
Debug

Phone Lock

Keypad Lock Enable: Disable

Keypad Lock Type: Menu Key

Phone Unlock PIN(0~15 Digit): ***

Phone Lock Time Out(0~3600s): 10

Emergency: 110,120,119,911

Confirm Cancel

1. Keypad Lock Enable: select "Yes" or "No" to enable or disable keypad lock
2. Keypad Lock Type: Menu key/Function keys/All keys/Answer call only.

3. Phone Unlock PIN(0~15 Digit):set the phone unlock PIN. Range: 0~15 digit.
4. Phone Lock Time Out(0~3600s): set the phone lock time out. Range: 0~3600s
5. Emergency :set emergency number. Default to 110.120.119 and 911.

5. Reboot

After the restart, the phone will back to standby interface.

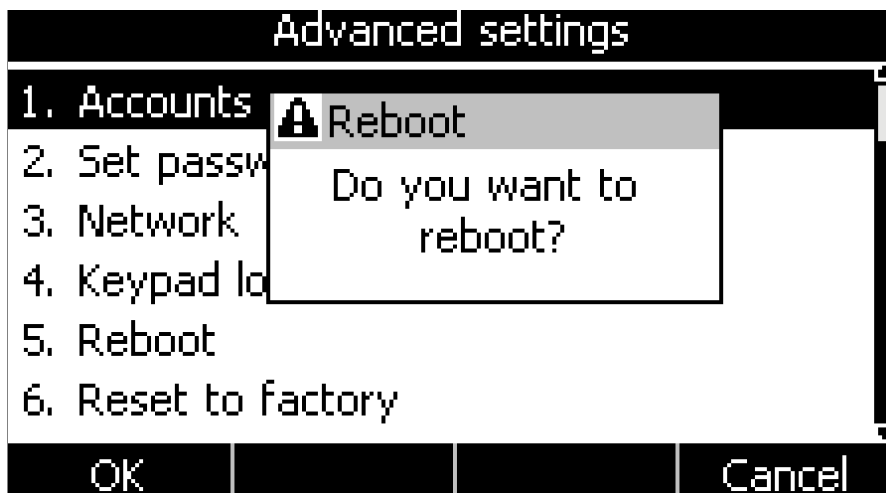

Reboot via webpage: **Phone**→**Upgrade**→**Reboot**

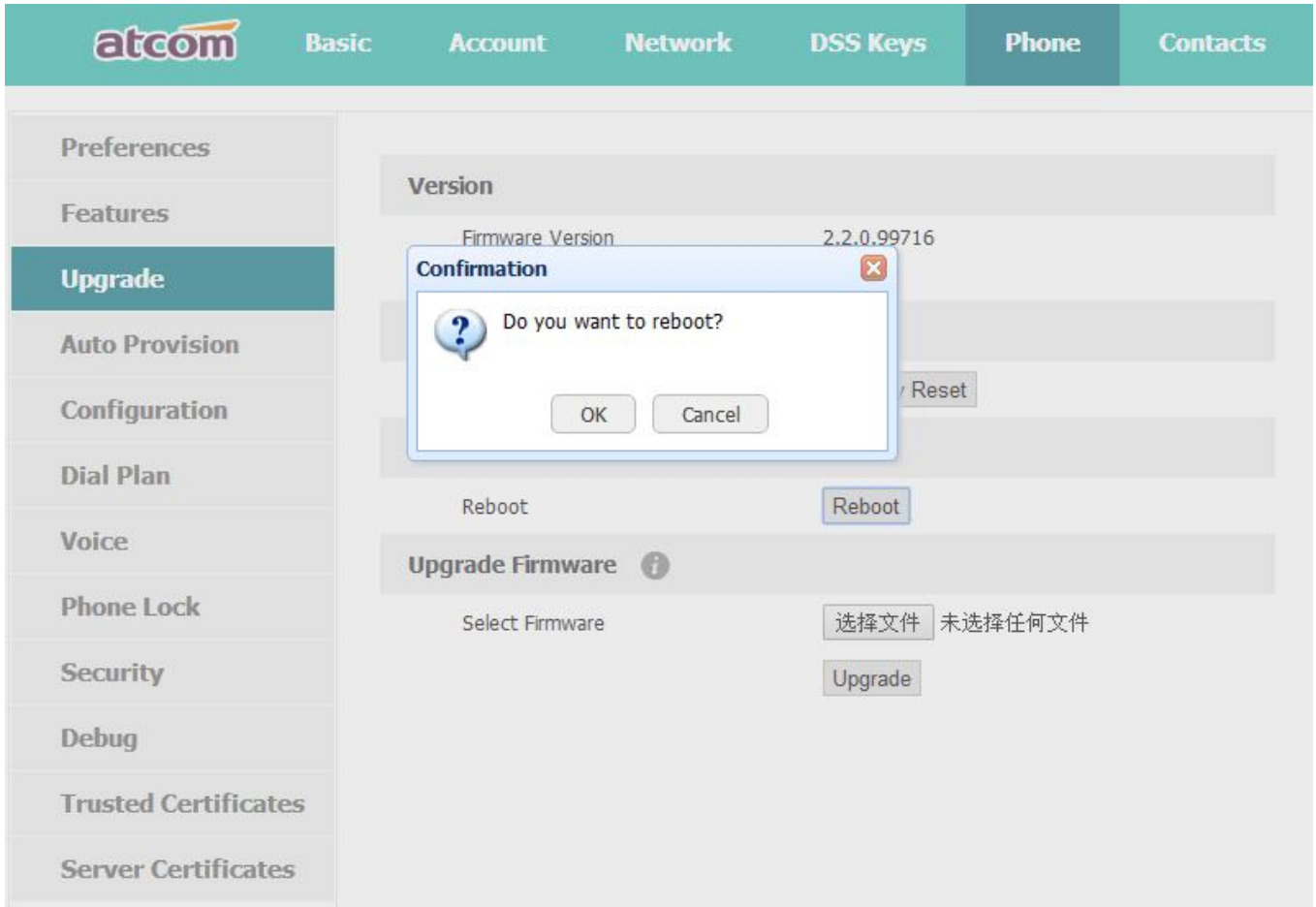

6. Reset to factory

Once reset to factory, all parameter settings will back to the factory default value, and all configure will be cleared, users must be careful on this.

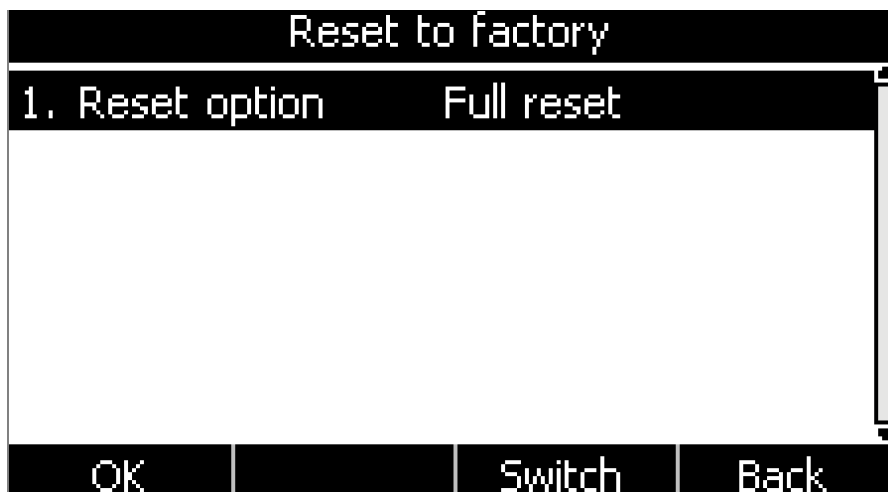

Reset Option: **Full Reset**, **Config Reset** and **UserData Reset**.

Reset to factory via Web: **Phone→Upgrade→Reset to Factory.**

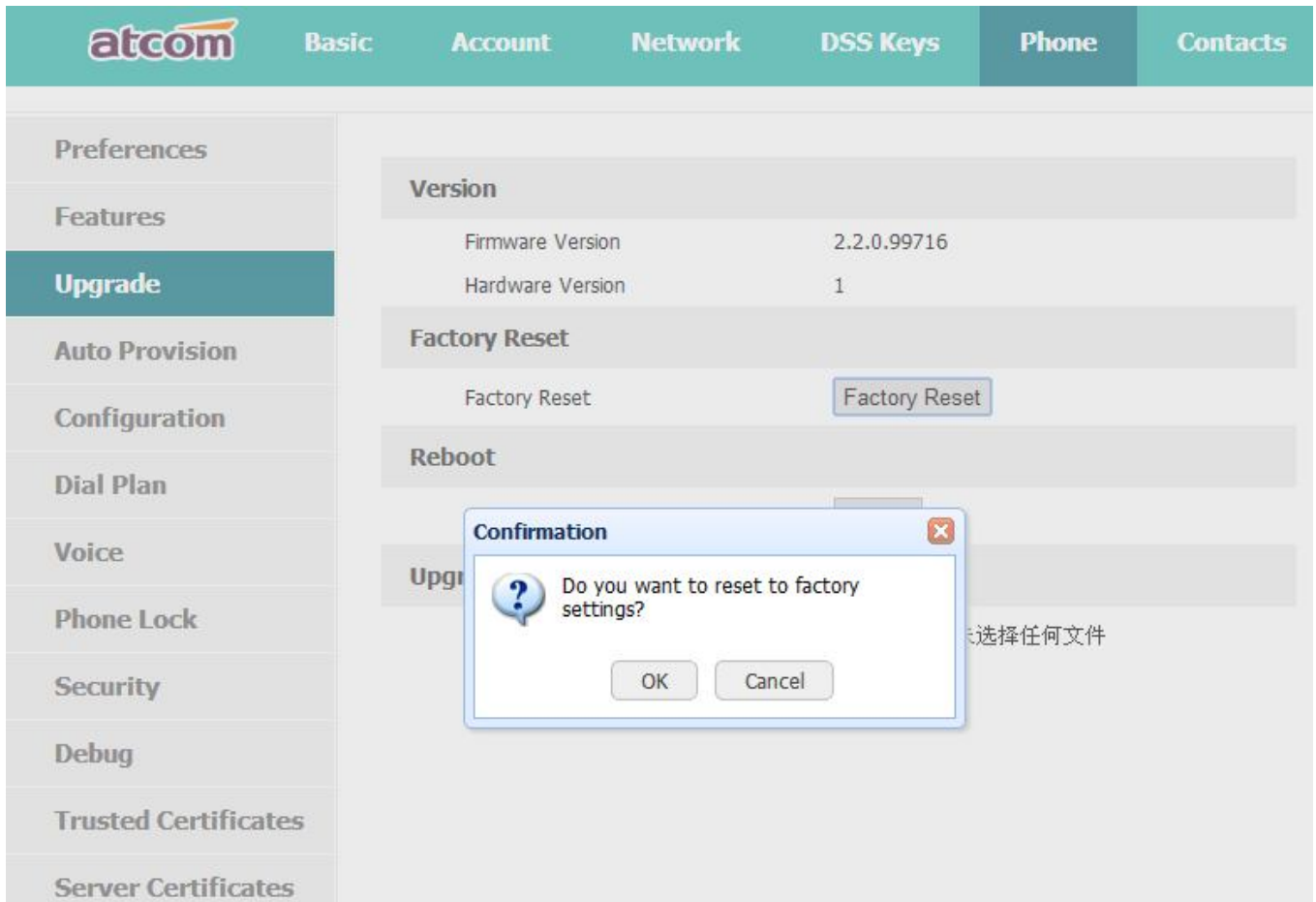



4.9. Display

For more convenient, users are able to adjust the contrast grade and backlight of the main LCD display.



1. Slave Contrast

There are 9 different contrast grades for options, press the soft key "**Switch**" or the key .  for modification, 8 is the default value.



2. Backlight

Backlight is the brightness of LCD, also it has been defined as 9 different grades. The number "9" means the lightest.

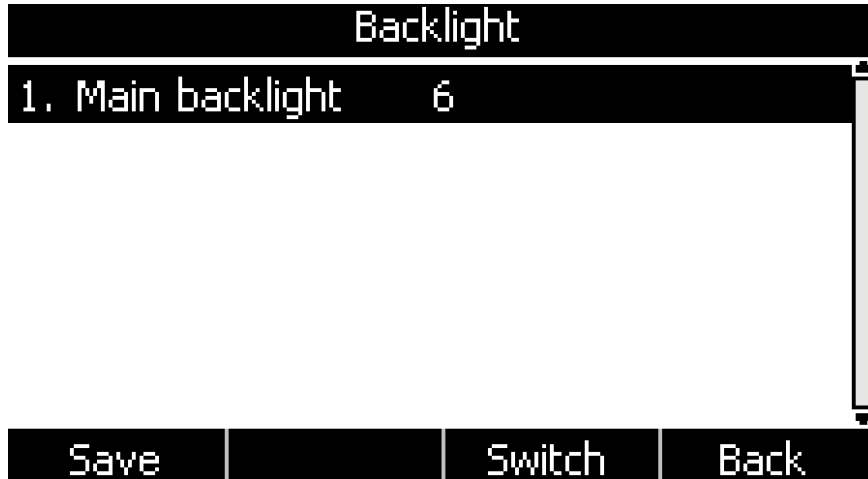

5. Advanced Feature

5.1. Codecs

D2X support multiple codecs, users can select the codes via Web.

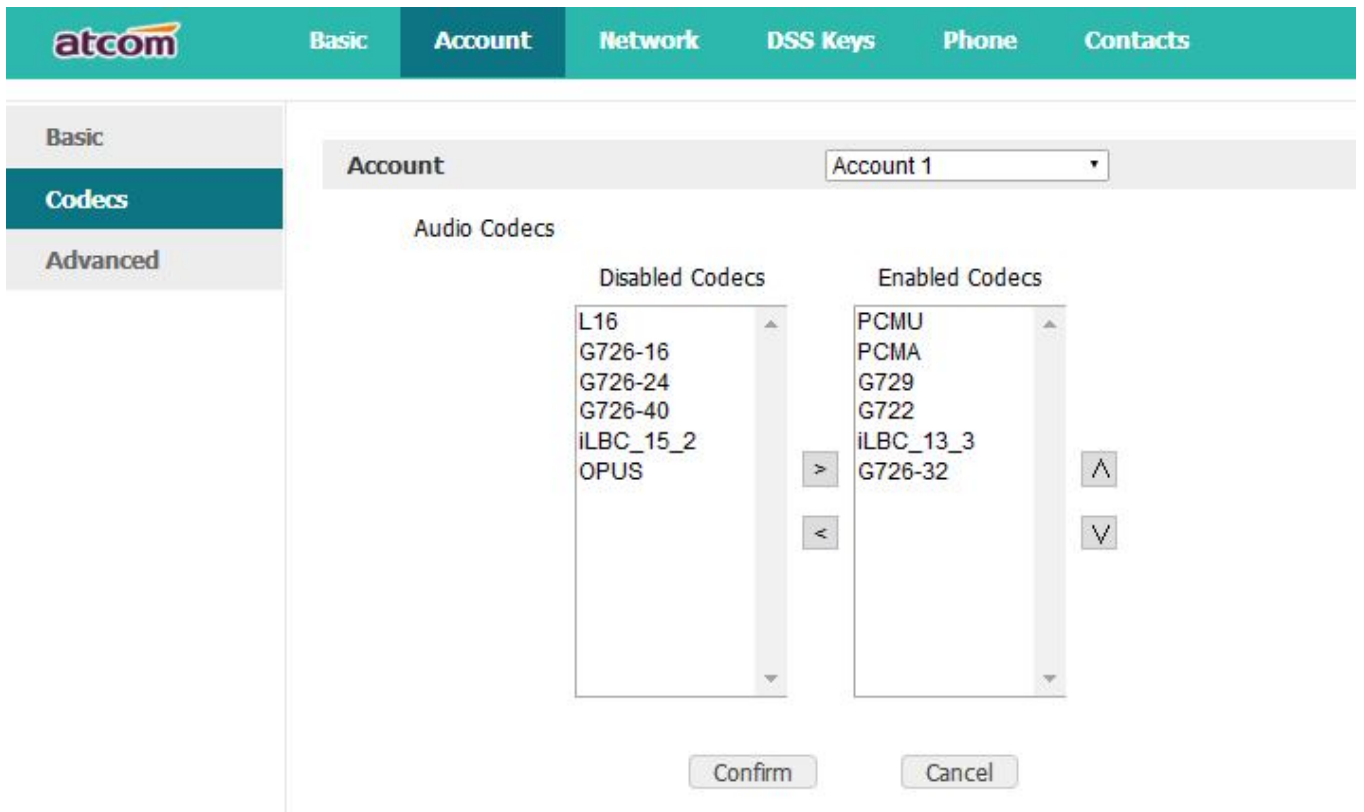

The codec include: PCMU, PCMA, G729, G722, iLBC_13_3, iLBC_15_2, G726-32, G726-16, G726-40, G726-24, L16, OPUS.



Notes: OPUS is our new support codec.

 means to enable the item of “Disabled Codes” ;

 means to disable the item of “Enabled Codes” ;

Click the button  or  to sort all enabled codes, the top item has the highest priority.

Note: Multiple different items of G726, iLBC should not activated simultaneously.

5.2. Capture and Upgrading

Capture package:

It would record the phone current info.

Via webpage: **phone**→**Debug**→**PCAP Feature**

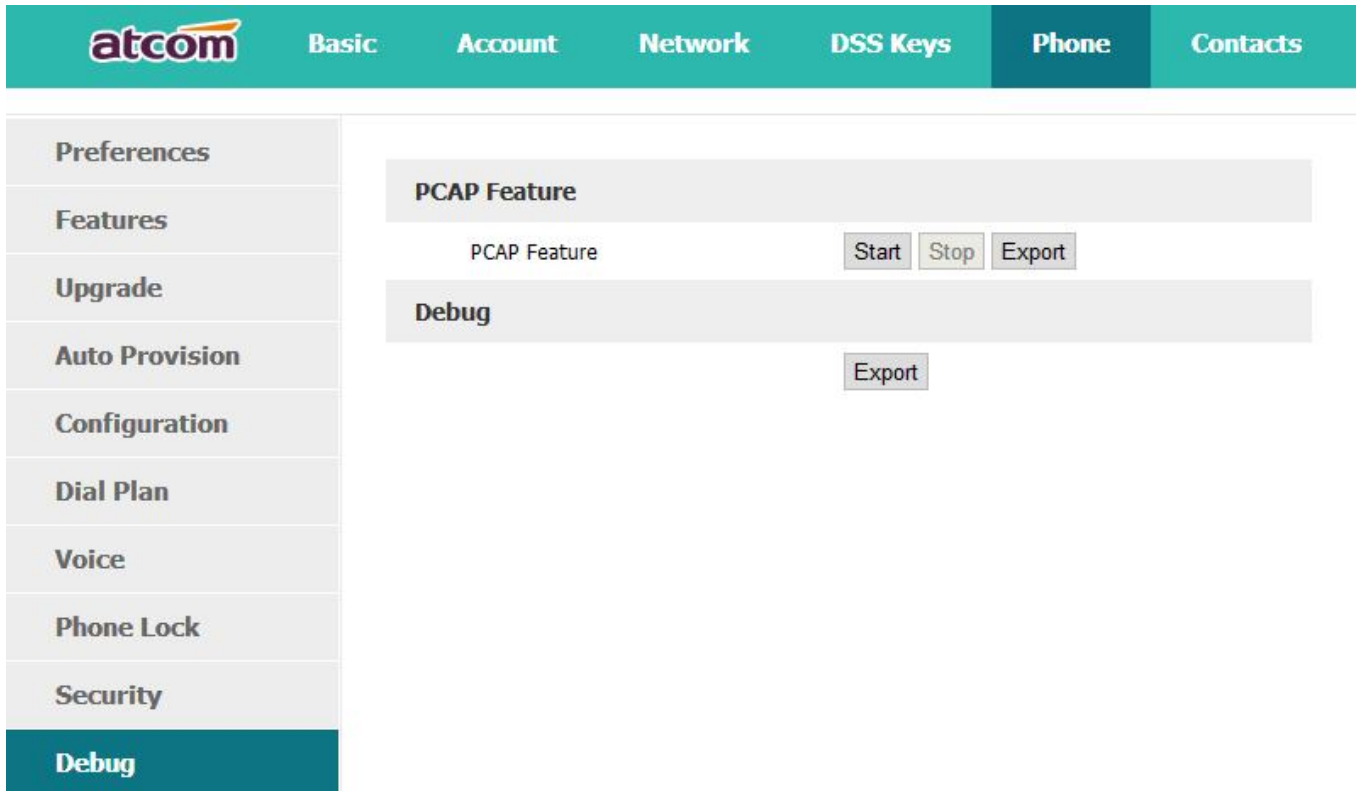

The screenshot shows the atcom web interface with the following structure:

- Top navigation bar: atcom logo, Basic, Account, Network, DSS Keys, **Phone**, Contacts.
- Left sidebar menu: Preferences, Features, Upgrade, Auto Provision, Configuration, Dial Plan, Voice, Phone Lock, Security, **Debug**.
- Main content area:
 - PCAP Feature** section: PCAP Feature, Start, Stop, Export buttons.
 - Debug** section: Export button.

Click the button "Start" to start the capture and click the button "Stop" to end the capture. Then click the button "export" to download the capture file.

Upgrade firmware:

Via webpage: **phone** → **Upgrade** → **Upgrade Firmware**

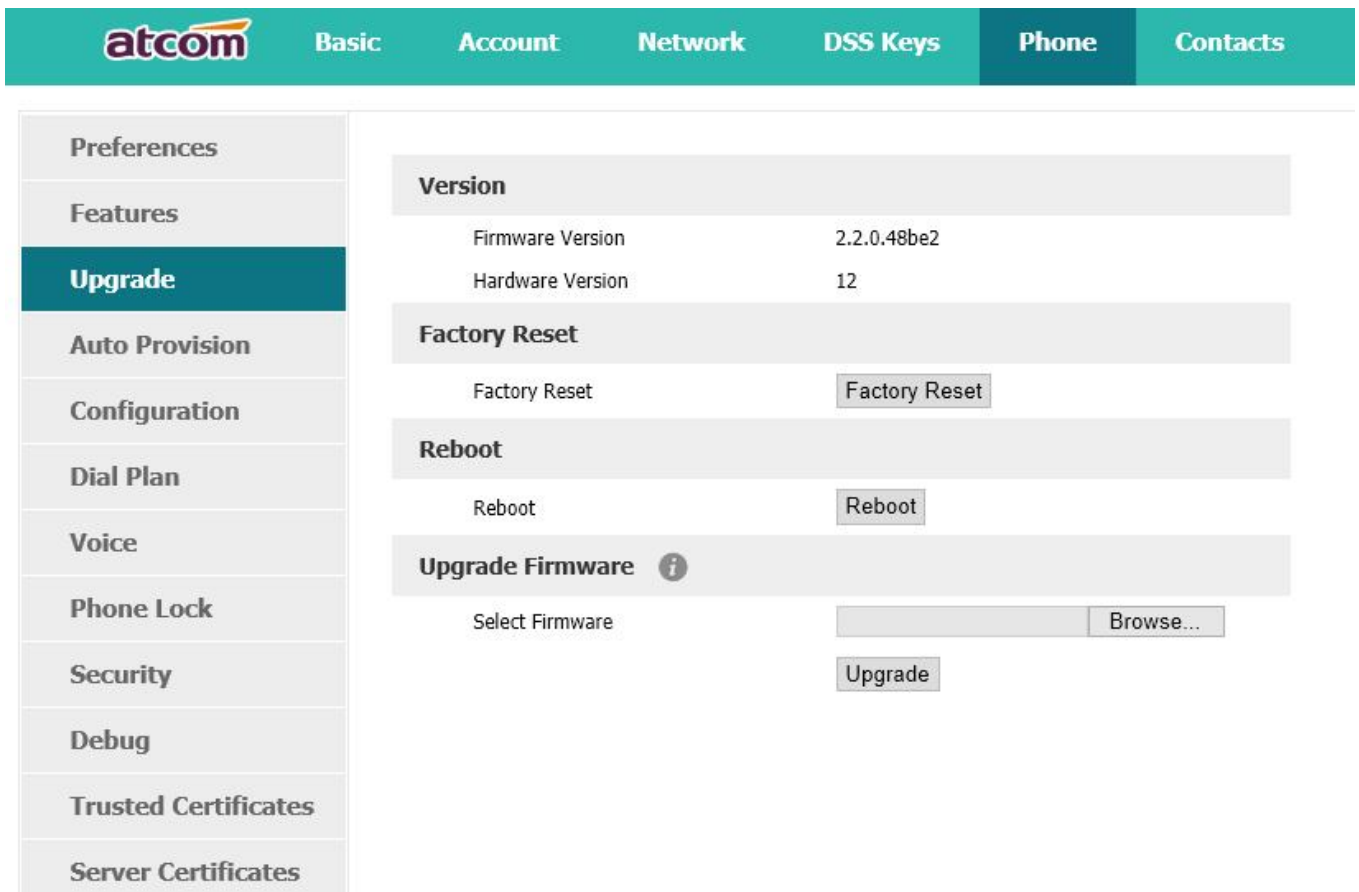



The screenshot shows the ATCOM web interface with the 'Phone' tab selected. The left sidebar contains a menu with the following items: Preferences, Features, Upgrade (highlighted), Auto Provision, Configuration, Dial Plan, Voice, Phone Lock, Security, Debug, Trusted Certificates, and Server Certificates. The main content area is divided into several sections:

- Version**: Displays 'Firmware Version' as 2.2.0.48be2 and 'Hardware Version' as 12.
- Factory Reset**: Contains a 'Factory Reset' button.
- Reboot**: Contains a 'Reboot' button.
- Upgrade Firmware**: Contains a 'Select Firmware' input field, a 'Browse...' button, and an 'Upgrade' button.

Before upgrading the firmware of phone, users are suggested to check the version of current firmware. Click the button "Choose file" to select the target local file and click "Upgrade" to process upgrading, this will cost a couple of minutes. And after reboot, the phone will be upgraded successfully.

5.3. Auto Provision

User is able to configure the phone to upgrade automatically.

atcom		Basic	Account	Network	DSS Keys	Phone	Contacts
Preferences							
Features							
Upgrade							
Auto Provision							
Configuration							
Dial Plan							
Voice							
Phone Lock							
Security							
Debug							
Auto Provision							
PnP Active			<input checked="" type="radio"/> On <input type="radio"/> Off				
DHCP Active			<input checked="" type="radio"/> On <input type="radio"/> Off				
Provisioning Server			<input type="text"/>				
User Name			<input type="text"/>				
Password			<input type="text"/>				
Common AES Key			<input type="text"/>				
MAC-Oriented AES Key			<input type="text"/>				
Check New Config			<input checked="" type="radio"/> On <input type="radio"/> Off				
Repeatedly			<input type="radio"/> On <input checked="" type="radio"/> Off				
Interval(minutes)			<input type="text" value="1440"/>				
Weekly			<input type="radio"/> On <input checked="" type="radio"/> Off				
Time			<input type="text" value="03"/> : <input type="text" value="00"/> -- <input type="text" value="03"/> : <input type="text" value="00"/>				
Day of week			<input checked="" type="checkbox"/> Sunday <input checked="" type="checkbox"/> Monday <input type="checkbox"/> Tuesday <input type="checkbox"/> Wednesday				

Item	Description
PnP Active	Select "On" or "Off" to enable or disable PNP automatic updates
DHCP Active	Select "On" or "Off" to enable or disable DHCP option automatic updates
Provisioning Server	The address to save control file for auto upgrading, it can filled by http, https, tftp and ftp server, for example, tftp://192.168.1.111
User Name	The username to access the file server
Password	The password to access the file server
Common AES Key	Configures the plaintext AES key for decrypting the Common CFG file
MAC-oriented AES KEY	Configures the plaintext AES key for decrypting the MAC-oriented CFG file

Check New Config	If set this parameter as "On", the phone will do some check for upgrading, and it will upgrade automatically once the conditions are met
Repeatedly	If set this parameter as "On", the phone will do some check for upgrading after "Interval(minutes)", and it will upgrade automatically once the conditions are met
Interval(minutes)	This parameter is configurable once the Repeatedly is "On"
Weekly	If set this parameter as "On", the phone will do the check for upgrading at a certain time in every week
Time	The time range that the phone do the check for upgrading every week, and it's configurable once the Repeatedly is "On"
Day of week	The day of week that the phone do the check for upgrading every week, and it's configurable once the Repeatedly is "On"

5.4. Export & Import configuration file

If user wants to set the same configuration on multiple phones, there is an easy way that export the configuration file from one phone and then import this file into other phones. This operation can be completed via Web only.

Import / Export Config

Import File 

Choose file No file chosen

Export User Data

5.4.1. Export configuration file

There is two ways to export the configuration files,

- Don't check the "Export User Data" and click "Export" directly, it will export the template of the configuration file;
- Check the "Export User Data" and then click "Export", it will export a configuration file that carries with user's configured data.

To modify the exported configuration file, you should to decompress it until you get a file names as configuration.

Name	Date modified	Size
configuration	2014/10/10 11:14	
config.tar.gz	2014/10/10 11:14	9 KB

The content of configuration file listed as below,

Name	Date modified	Type	Size
Calllist	2014/10/10 11:14	File folder	
Contacts	2014/10/10 11:14	File folder	
DialRule	2014/10/10 11:14	File folder	
Features	2014/10/10 11:14	File folder	
Network	2014/10/10 11:14	File folder	
Phone	2014/10/10 11:14	File folder	
Setting	2014/10/10 11:14	File folder	
voip	2014/10/10 11:14	File folder	

5.4.2. Import configuration file

Click the button "Choose file" to select the target file for importing, and then click the button "Import". The phone will be rebooted a couple of minutes later, and import successfully.

Note: If some part of the configuration file has been modified manually, it must be re-compressed as the format of "tar.gz" in Linux

5.5. Export System log

When the phone doesn't working well, System log is the best assistant tools for troubleshooting, all operation details has been recorded. This operation is available via Web only.

Export System Log

Log Location Local Server ?

Server Name

Log Level

Item	Description
Log Location	You can import the system log to local PC or remote Server.
Server Name	User must fill the address of server if you choose to export the system log to remote server.
Log Level	It defines the detail of system log as 5 different levels, Fatal, Error, Warning, Info, and Debug. The Debug level is the most detailed.

5.6. Dial plan

The customized Dial Plan are available , for example , the rule of replacement, Instant Calling, Area code, Restriction of Outbound.

Before customizing the dial plan, user must learn the basic grammar as below,

.	Represent a character or multiple ones, e.g., "6." can match "66", "678", "6plus" and so on
x	Represent one character, e.g., "6x" can match "61", "62", " 6s" and so on
[]	Represent a character in one range, e.g., " 83[0-5]18618" can match "83018618", "83488618" and so on
()	Represent the combination of characters, e.g., "([1-9])([2-7])3" can match "923", "153", "773" and so on
\$	Add a number after the character "\$" to define the location of the characters, e.g., use the prefix " 8([1-3])(.)" to replace "7\$2", the phone will call "7837" after dialing out "82837"

Note: Any operations (add, modify or delete) on the current dial plan will be not effective until click "Save".

5.6.1. Replace Rule

Dial plan "Replace Rule" means to replace a batch of complicated character string by some simple characters, to make a speed dial.

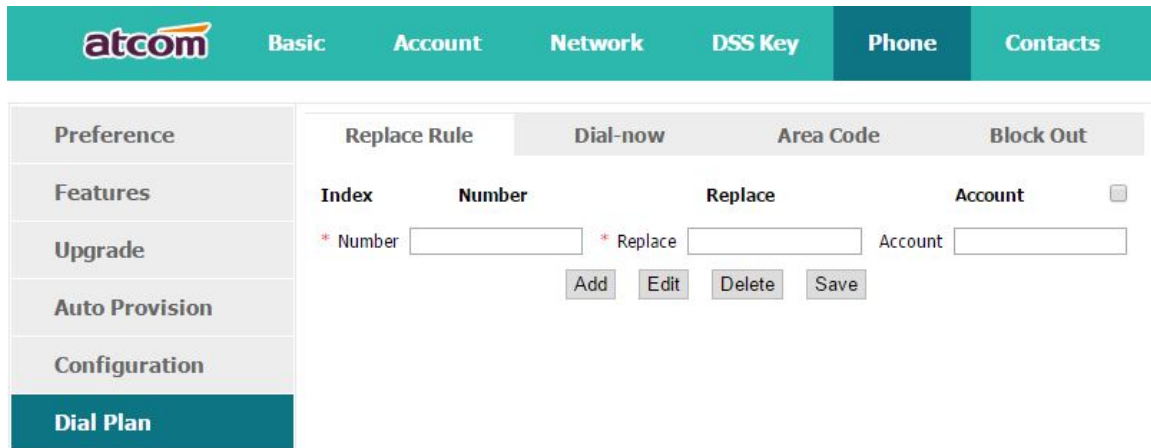

Item	Description	Sample
Number	The string works as replacer, not null	Set Number as "6", Set Replace as "6032", Set Account as "1". It means when dial 6, the phone will dial 6032.
Replace	The string that to be replaced, not null	
Account	The account to apply this dial plan, blank or 1~4 is valid.	
Add	Multiply replace rules can be configured in one phone, after one replace dial plan configured, click this button to add a new one	
Edit	The existed replace dial plans are editable. The specified dial plan should be selected until it is covered with orange and the input fields "Number" and "Replace" shows the details correctly. After modifying, click button "Edit" to make it to be effect	
Delete	Delete one added or saved replace dial plan or multiple ones, click the frame after the specified replace dial plan before delete it, and then click button "Delete"	

Save	Any alteration won't take effect until the button "Save" is clicked.	
-------------	--	--

5.6.2. Dial-now

Dial plan "Dial-now" permits the corresponding phone to be dialed instantly without pressing the soft key "Dial", once the input has been matched. It works like a hotline.

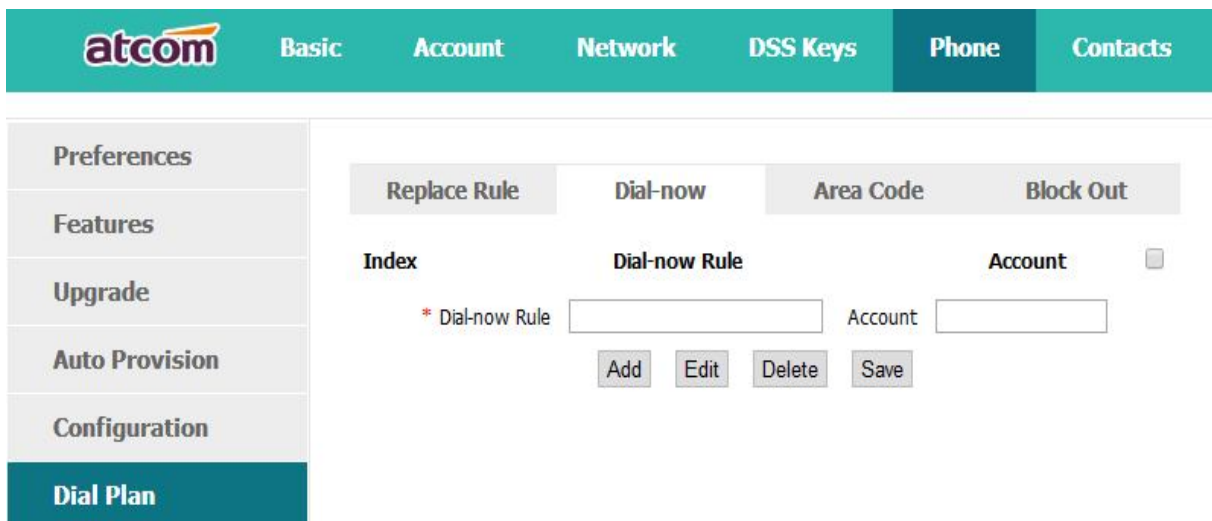

Item	Description	Sample
Dial-now Rule	The string to be dialed out automatically by the phone	Set "Dial-now Rule" as 6xxx, keep "Account" as null
Account	The account to apply this dial plan, blank or 1~4 is valid.	It means the phone will use the 1st available account to call 6033 after "Dial-now Time-out" seconds when inputting four figures begin with 6
Add	Multiply dial-now rules can be configured in one phone, after one dial-now dial plan configured, click this button to add a new one	
Edit	The existed dial-now dial plans are editable. The specified dial plan should be selected until it is covered with orange and the input fields "Number" and "Dial-now" shows the details correctly. After modifying, click button "Edit" to make it to be effect	

Delete	Delete one added or saved dial-now dial plan or multiple ones, click the frame after the specified dial-now dial plan before delete it, and then click button "Delete"	numbers matches the dial plan, and hotline takes effect in situation that the phone is in dialing state
Save	Any alteration won't take effect until the button "Save" is clicked.	

Set "Dial-now Time-out" via web: **Phone**→**Features**→**General Information**→**Dial-now Time-out (secs)**.

5.6.3. Area Code

Dial plan "Area Code" has been defined to identify each different area. To call a phone number of other areas, user must add the area code to be in front of the phone number. For convenience, area code has been recommended to be configured while frequently dialing to that type of phone number.

Item	Description	Sample
Code	The area code dialed before the number	Set "Code" as "0086577",
Minimum length	The minimum length of the number input to activate the area code dial plan	Set "Minimum length" as "5".
Minimum length	The minimum length of the number input to activate the area code dial plan	It means when dialing 83018618 with the 5 th account, the phone will dial 0086577 before it.
Account	The account to apply this dial plan, blank or 1 is valid.	Note: If the length of the number input in the dial UI

Confirm	Apply this dial plan	is not between minimum length and the mD2X(w)imum length, area code will not take effect
Cancel	Recover all input fields to the state that saved at latest time	

5.6.4. Block Out

Dial plan "Block out" is used to prohibit the phone number outgoing call from some accounts.

Replace Rule	Dial-now	Area Code	Block Out
Block Out Number1	<input type="text"/>	Account <input type="text"/>	<input type="text"/>
Block Out Number2	<input type="text"/>	Account <input type="text"/>	<input type="text"/>
Block Out Number3	<input type="text"/>	Account <input type="text"/>	<input type="text"/>
Block Out Number4	<input type="text"/>	Account <input type="text"/>	<input type="text"/>
Block Out Number5	<input type="text"/>	Account <input type="text"/>	<input type="text"/>
Block Out Number6	<input type="text"/>	Account <input type="text"/>	<input type="text"/>
Block Out Number7	<input type="text"/>	Account <input type="text"/>	<input type="text"/>
Block Out Number8	<input type="text"/>	Account <input type="text"/>	<input type="text"/>
Block Out Number9	<input type="text"/>	Account <input type="text"/>	<input type="text"/>
Block Out Number10	<input type="text"/>	Account <input type="text"/>	<input type="text"/>

Item	Description	Sample
Block Out Number	The number that prohibited	Set "Block Out Number 1"as"10086" It means the phone will enter the "Call End" UI when dial "10086"
Account	The account to apply this dial plan, blank or 1	
Confirm	Apply this dial plan	
Cancel	Recover all input fields to the state that saved at latest time	

6. FAQ

6.1. How to reset to factory

There are 3 methods for factory reset:

1. Factory reset via phone:

- a) Press the **Menu** softkey.
- b) Select "Settings", then press the soft key "Enter"
- c) Select "Advanced Settings", then press the soft key "Enter"
- d) Input the access password, then press the soft key "Enter"
- e) Select "Reset to factory", then press the soft key "Enter"
- f) Press the soft key "OK", then the phone will be reboot and resumed to factory default settings

2. Factory reset via Web:

- a) Key in the IP address of phone with a browser,
- b) Access the webpage of phone as the role of "admin", username/password is admin/admin.
- c) Select "Phone"
- d) Select "Upgrade"
- e) Click the button "Reset to Factory"
- f) Click the button "OK"

3. Factory reset during starting:

- a) Hold the key "*" and "#" while power on for 5 seconds
- b) The phone will be reboot and resumed to factory default setting

6.2. Upgrade the firmware on safe mode

If the phone can't be started successfully, user is able to upgrade the firmware on post mode,

- a) Setup a TFTP Server and set the PC's IP address as "192.168.1.200"
- b) Copy the kernel file we supplied to the root menu of TFTP Server
- c) Ensure the TFTP Server and phone are connected to the same network switch and both reachable
- d) Long Press the key "*" and "1" to upgrade the kernel file, and then plug in power until upgrading information displayed on LCD
- e) The phone will start downloading file from TFTP server
- f) After downloading completed, the phone will be automatically upgraded
- g) After upgrading completed, the phone will be started with the factory default settings

6.3. How to make IP Peer to Peer call

1. Press it in dialing status
2. To make a IP peer to peer call

Switch the input type to '1aA', then press '*' key to choose '.'. For example, to dial "192.168.1.100":

1. Change to '1aA' input method;
 2. input "192","*", "168", "*", "1", "*", "100"
3. Disable the IP call feature

Via webpage modify the make IP call feature:

Phone→Feature →Accept SIP Trust Server Only, press "Enable".

Basic
Account
Network
DSS Keys
Phone
Contacts

Preferences

Features

Upgrade

Auto Provision

Configuration

Dial Plan

Voice

Phone Lock

Security

Debug

Trusted Certificates

Server Certificates

+ Call Forward i

+ Do Not Disturb

- General Information

Inter Digit Time(secs)	<input type="text" value="8"/>	(1~14)	i
Auto Answer	<input type="text" value="Disabled"/>		i
Call Waiting	<input type="text" value="Enabled"/>		i
Hotline	<input type="text"/>		i
Hotline Time-out(0~180 secs)	<input type="text" value="4"/>		i
Key As Send	<input type="text" value="#"/>		i
Dial-now Time-out(secs)	<input type="text" value="1"/>		i
Busy Tone Timer(secs)	<input type="text" value="0"/>		i
Return Code When Refuse	<input type="text" value="486 (Busy here)"/>		i
Return Code When DND	<input type="text" value="480 (Temporarily not a"/>		i
RFC 2543 Hold	<input type="text" value="Enabled"/>		i
Use Outbound Proxy in Dialog	<input type="text" value="Disabled"/>		i
Login Time-out(1~1000 minutes)	<input type="text" value="10"/>		i
Hide DTMF	<input type="text" value="Disabled"/>		
Watch Dog	<input type="text" value="Enabled"/>		
Accept SIP Trust Server Only	<input type="text" value="Enabled"/>		

7. Trouble shooting

7.1. The phone is failed to register to SIP server

1. First of all, check the IP address. If the LAN port is DHCP, please ensure the DHCP server has been enabled.

2. Check the network gateway
3. Check the DNS
4. Make sure the input account matched the one provided by Service Provider
5. Make sure SIP Server has been enabled already
6. Make sure the Port of SIP Server, it's 5060 by default

7.2. The phone is failed to gain IP address

1. Make sure the network cable has been plugged into the LAN port
2. Make sure the network cable or port of network switch are working fine,
3. Make sure the DHCP server has been enabled, and there are available IP address
4. Try to set the LAN port as Statics IP

7.3. Only one party can hear from another on calling

1. Try to make a IP peer to peer call, to make sure the mic and speaker are working fine
2. Enable STUN via Web
3. Set the address of STUN Server, for example stun.sipgate.com
4. Present this operation above and the phone will be reboot
5. Try to make a normal call again

8. Abbreviation

DND: Do Not Disturb

CFWD: Call Forward

Bxfer: Blind Transfer

Conf: Conference

Num: Number

SIP: Session Initiate Protocol

RTP: Real-time Transport Protocol

SDP: Session Description Protocol

VPN: Virtual Private Network

VLAN: Virtual Local Area Network

QoS: Quality of Service

Syslog: System log

UDP: User Data Protocol

TCP: Transmission Control Protocol

TLS: Transport Layer Security Protocol

BLF: Busy Lamp Field

DNS: Domain Name System

SRTP: Secure Real-time Transport Protocol

NTP: Network Time Protocol

VAD: Voice Activity Detection

CNG: Comfort Noise Generator

9. FCC Caution

Any Changes or modifications not expressly approved by the party responsible for compliance could void the user's authority to operate the equipment.

The device complies with part 15 of the FCC Rules. Operation is subject to the following two conditions: (1) The device may not cause harmful interference, (2) the device must accept any interference received, including interference that may cause undesired operation.

Note: This equipment has been tested and found to comply with the limits for a Class B digital device, Pursuant to part 15 of the FCC Rules. These limits are designed to provide reasonable protection, uses and can radiate radio frequency energy, and if not installed and used in accordance with the instructions, may cause harmful interference to radio communication. However, there is no guarantee that interference will not occur in a particular installation. If this equipment does cause harmful interference to radio or reception, which can be determined by turning the equipment off and on, the user is encouraged to try to correct the interference by one or more of the following measures:

- Reorient or relocate the receiving antenna.
- Increase the separation between the equipment and receiver.
- Connect the equipment into an outlet on a circuit different from that to which the receiver is connected.
- Consult the dealer or an experienced radio/TV technician for help.