



User Manual

DS322LR4-1



DynaScan

Version 2.00

The use of diagrams and illustrations in the manual are for reference only. The actual product may be different.
Product design and specifications are subject to change without notice

Contents

Material Contents Declaration	2
Recycling and Energy Information	2
Declaration of Conformity	3
Safety Precautions	4
Safety Precautions	4
Important Safety Information	5
Getting Started	6
Contents	6
Installing and Replacing Remote Control Batteries.....	6
Installation.....	7
Mounting.....	7
Wall Mounting.....	10
Connecting to a Power Source.....	10
Connecting an External Video Source	11
Connector Positions	12
Input / Output Terminals.....	13
Operating Instructions	14
Powering On/Off the Display	14
Using the Remote Control	14
Using the Rear Panel Controls.....	17
Navigating the On Screen Display (OSD) Menu	18
Specifications	19
Input Mode.....	20
Pin Assignments.....	21
Digital RGB Input (DVI-D): DVI	21
RS-232 Input	21
Troubleshooting.....	22

Material Contents Declaration

Part Name	Hazardous Substances					
	Lead	Mercury	Cadmium	Hexavalent Chromium	Polybrominated Biphenyls	Polybromodiphenyl Ethers
	Pb	Hg	Cd	Cr ⁶⁺	PBB	PBDE
PCBA	○	○	○	○	○	○
CHASSIS	○	○	○	○	○	○
ACCESSORY	○	○	○	○	○	○
PACKAGE	○	○	○	○	○	○

“○” indicates that the level of the specified chemical substance is less than the threshold level specified in the standards of SJ/T-11363-2006 and EU 2005/618/EC.
 “×” indicates that the level of the specified chemical substance exceeds the threshold level specified in the standards of SJ/T-11363-2006 and EU 2005/618/EC.

Recycling and Energy Information

DynaScan is firmly committed to its environmental protection efforts and we believe that reducing our products' impact on the environment is of the utmost importance. We are dedicated to meet the latest environmental protection regulations.

Energy usage

Mode	Energy Consumption
Normal	Max. 190 W
Standby	< 5 W

Disposal

Do not dispose of electrical appliances as unsorted municipal waste, use separate collection facilities. Contact your local government for information regarding the collection systems available. If electrical appliances are disposed of in landfills or dumps, hazardous substances can leak into the groundwater and get into the food chain, damaging your health and well-being. When replacing old appliances with new one, the retailer is legally obligated to take back your old appliances for disposal at least for free of charge.



Declaration of Conformity

FCC Verification

This device complies with Part 15 of the FCC Rules. Operation is subject to the following two conditions: (1) this device may not cause harmful interference, and (2) this device must accept any interference received, including interference that may cause undesired operation.

FCC Information

This equipment has been tested and found to comply with the limits for a Class A digital device, pursuant to Part 15 of the FCC Rules. These limits are designed to provide reasonable protection against harmful interference when the equipment is operated in a commercial environment. This equipment generates, uses, and can radiate radio frequency energy and, if not installed and used in accordance with the instruction manual, may cause harmful interference to radio communications. Operation of this equipment in a residential area is likely to cause harmful interference in which case the user will be required to correct the interference at his own expense.

Declaration of the Manufacturer	
<p>We hereby certify that the Professional LCD DS322LR4-1 is in compliance with</p> <p>Low Voltage Directive 2006/95/EC</p> <p>Electromagnetic Compatibility Directive 2004 /108 /EC</p> <p>IEC 60950-1:2005 (2nd Edition) +Am1:2009</p> <p>EN 60950-1:2006+A11:2009+Am1:2010+A12:2011</p> <p>EN 55022:2010+AC:2011 Class A ITE</p> <p>EN 61000-3-2:2006+A1:2009+A2:2009</p> <p>EN 61000-3-3:2008</p> <p>EN 55024:2010</p> <p>EN 61000-4-2:2009</p> <p>EN 61000-4-3:2006+A1:2008+A2:2010</p> <p>EN 61000-4-4:2012</p> <p>EN 61000-4-5:2006</p> <p>EN 61000-4-6:2009</p> <p>EN 61000-4-8 :2010</p> <p>EN 61000-4-11:2004</p>	 <p>DynaScan Technology, Inc.</p>
<p>VCCI report ready.</p> <p>VCCI Class A ITE</p> <p>V-3/ 2013.04 Technical Requirements</p> <p>V-4/ 2012.04 Supplementary Test Conditions for Equipment under Test</p>	

Safety Precautions

CAUTION	
	Do not install the display in a wet environment or place anything filled with liquid such as a vase or beverage on top of it.
	Do not install the display near flammable objects such as gasoline or other volatile liquids.
	Do not install the display near any heat sources such as radiators or other heating devices.
	Do not install the display in the dusty environment.
	Do not damage the power cord or plug.
	Do not disassemble the screen to avoid electric shock.
	The product can normally be operated at an altitude under 2000m. Abnormalities may occur when installing the device at an altitude above 2000m.



WARNING	
	The heat sink behind the screen may be hot after extensive use. Do not touch it to avoid being burned.
	Do not touch the screen panel with sharp objects or extreme pressure to avoid damaging the panel.
	The display should be installed in well-ventilated place, do not install it in a confined space.
	Do not drop or allow any objects to fall on the screen.
	Do not touch the screen with wet hands to avoid electric shock.
	Unplug the power cord before cleaning the device. Use a soft and dry cloth to wipe the screen off. Do not use alcohol or other chemical liquids.
	If you smell smoke or hear strange noises, immediately unplug the monitor and contact the vendor.
	Do not discard this product with general household waste. Be sure to comply with the local waste regulations for disposal.
	Suitable for mounting on concrete and non-combustible surface only.
	Please pay attention to the ground wire in a sensible and professional manner. Keep ground wire connected to prevent electrical shock.

IMAGE BURN-IN WARNING	
	When a stationary or fixed image is displayed on the screen for a long time, the image may be permanently imprinted on the screen. This phenomenon is known as image burn-in and is not covered by the manufacturer's warranty.
	In order to avoid burn-in, avoid prolonged display of static or fixed images on the screen.

Important Safety Information

- Disassembling the LCD is strictly prohibited. Opening the cover may expose the user to electric shock or other hazards. Please contact DynaScan certified service professionals for all maintenance requirements.
- Do not allow any liquid to enter the LCD. Also avoid placing the LCD close to water sources.
- Do not place heavy objects on the power cord. A damaged power cord might cause electric shock or fire.
- Do not bend, twist, or damage the power cord.
- The power cord must comply with the local safety regulations.
- Do not damage or modify the prongs/pins and the ground contact on the power cord plug.
- Do not place the LCD on an unlevelled surface or an unstable vehicle. The LCD could fall over and cause substantial damage.
- Do not cover the vents and/or the heat sink.
- Do not install the LCD beside radiators or other heat sources. The installation site should have sufficient ventilation so the heat generated by the LCD can be dissipated.
- Do not use the Signage in a hot, humid, dusty, or fummy environment.
- Handle the LCD with care. Save the packaging materials for transport later.
- Clean the LCD backside at least once a month for dust and other particles.

Unplug the LCD immediately and contact a DynaScan certified service professional as soon as possible when any of the following situations occurs:

- Damaged power cord or power plug.
- If liquid or foreign object has entered the LCD.
- If the LCD has been exposed to rain or water.
- If the LCD has been dropped or the casing has become damaged.
- If any structural damage such as cracks or unnatural vibration is found.
- If the LCD cannot be operated following the steps outlined in this manual.
- If the LCD emits smoke or other odors, or generates strange noises.

Operating Suggestions

- Avoid displaying a stationary image for a long period of time in order to prevent image sticking.

Cleaning the Panel

- Use a soft, lint-free cloth to gently wipe the dust off from the screen panel.
- Do not use any hard material to wipe the panel.
- Do not poke the panel with your hand or any sharp object (such as a pen or a nail) or exert excessive pressure on the panel to prevent any damage.
- Do not use any cleaning solutions on the panel as it might cause discoloration.

Cleaning the Casing

- Unplug the power cord.
- Gently wipe the casing with a soft cloth.

Attention

- Do not use any of the following solutions to clean the casing as they may damage the paint and cause it to crack or peel: benzene solution, alkaline solution, alcohol-based cleaning solution, glass cleaner, wax, polisher, or detergent.

Getting Started

Contents

Confirm that the accessories below are shipped along with the display. If any item is missing, please contact your dealer. The color and shape of the accessories may vary with the products.

- DS322LR4-1 Professional LCD.
- Remote Control x 1 pc.
- Batteries (1.5V / AAA) x2 pcs.
- Quick Start Guide x1 pc.
- Power cable x1 pc.
- RS-232 cable x1 pc.
- DVI cable x1 pc.
- Ethernet crossover cable x1 pc.

Attention: Please use the following table to check whether the included power cord is suitable for your region. If the power cord does not match your region, please contact your local supplier. Please use matching AC socket in order to meet your local safety regulations.

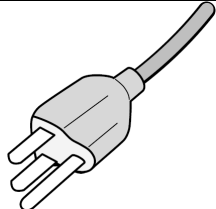
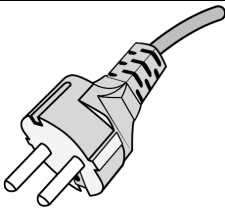
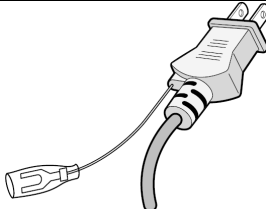
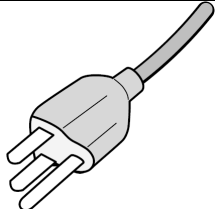
Plug Type	North America	European Continental	Japan	Taiwan
Plug Shape				
Region	U.S.A. / Canada	EU (Except U.K.)	Japan	Taiwan
Voltage	120V	230V	100V	110V

Installing and Replacing Remote Control Batteries

1. Open the battery compartment cover.
2. Insert 2 new AAA batteries.
3. Close the battery compartment cover.

Warning:

- Incorrect usage of batteries may cause leakage or explosion.
- Pay attention to the polarity when installing the batteries.
- Do not mix different types of batteries or new and used batteries. Doing so may shorten the battery life or cause leakage.
- Remove or replace the batteries when they are empty in order to prevent acid leaking in the battery compartment.
- Do not touch the leaked substance from the batteries in case of a battery leakage. Doing so may hurt human skin.

Note: If the remote control is not going to be used for a long time, we recommend removing the batteries from the remote control.

Installation

The LCD must be properly installed using a wall mount. Incorrect installation may cause injury or damage the equipment. Product warranty does not cover the damage caused by improper installation and DynaScan shall not be held responsible for such incident. Refer to the mount manufacturer's instructions for proper installation.

Mounting

- Hanging the Professional LCD from the ceiling or mounting it on the wall is the responsibility of the user. Not all ceilings or walls provide enough strength to support the LCD. The LCD may drop and cause serious injury if it is hanging from the ceiling with insufficient support or is mounted on a slanted wall. Product warranty does not cover improper installation, modification, or damage caused by natural disasters. DynaScan recommends having certified professionals to evaluate the installation site and perform the mounting operation.
- Do not to cover the vent and/or the heat sink in order to ensure proper heat dissipation.
- Refer to the installation guide provided by the manufacturer for proper mounting.

When mounting on a wall or hanging from a ceiling

- A wall mount is not included in the accessory. Please purchase a VESA Standard wall mount to secure the LCD. DynaScan is not responsible for the damage caused by using non-standard wall mounts.
- Verify that the mounting location can support the weight of the LCD before installation.
- The installation angle must be within 15 degrees of the vertical axis.
- Do not install the wall mount while the power is turned on as it may cause serious injury due to electrical shock.

Model Number	VESA (mm)		Screw Specification	Screw Length	Number
DS322LR4-1	(A * B)	200 * 200	M6	Greater than 10mm Smaller than 12mm (not including wall mount thickness)	4

DS322LR4-1

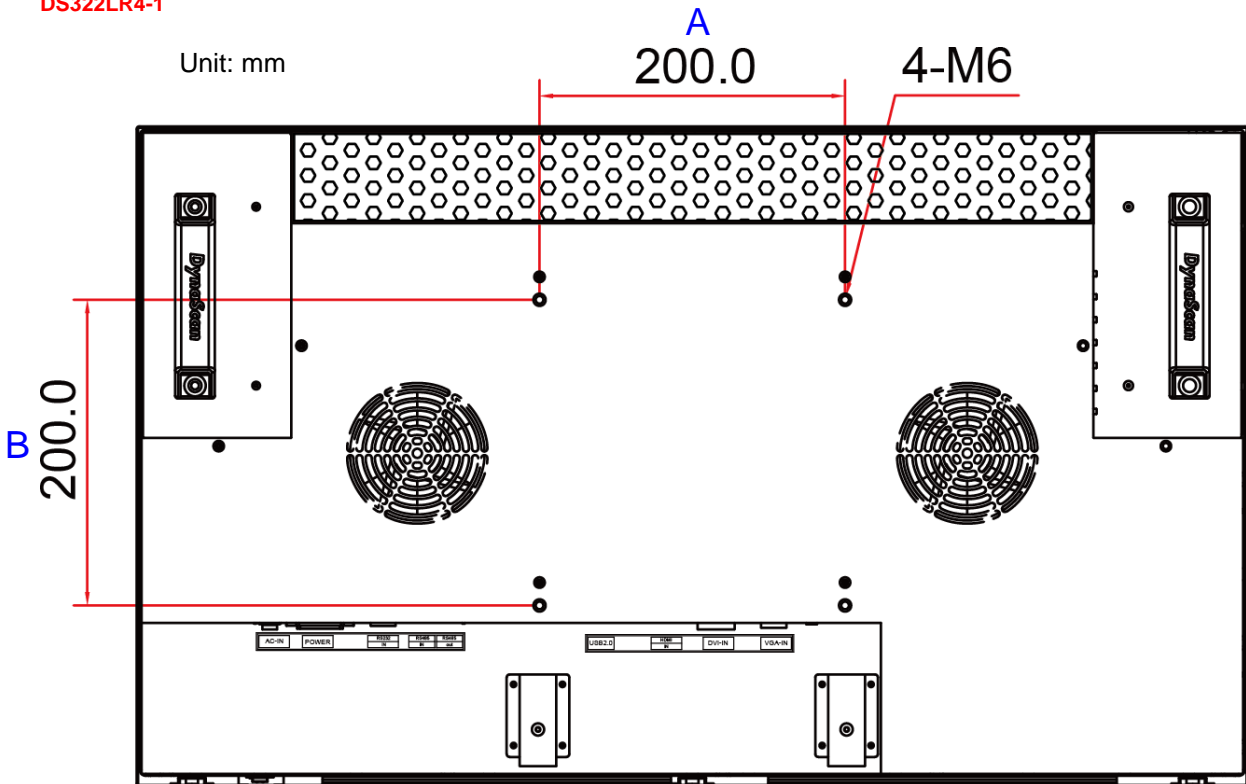

Orientation

- When used in the portrait orientation, the LCD should be rotated clockwise when looking at the front of the display such that the left edge becomes the top edge.

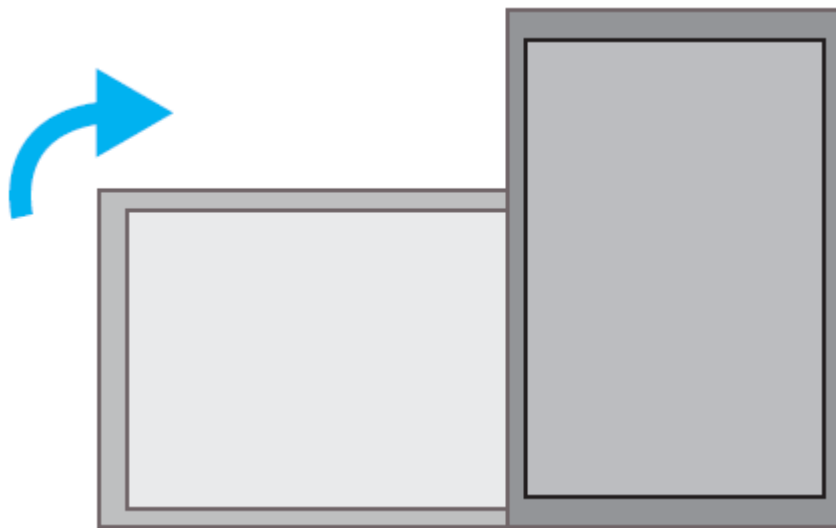

Portrait mode: Rotate the set clockwise 90° (mandatory)

Installation Location

- The wall and mount must have enough strength to support the LCD and its accessories.
- Do not install in a location with strong vibrations or is dusty.
- Do not install near the building's main electric panel.
- Ensure the LCD is secured in such a manner that it cannot be easily removed by the general public.
- Leave clearance around the outer edge of the LCD (or video wall matrix) from other objects to ensure proper ventilation.

- For installations with screens inset into the wall, refer to section: Enclosures for cooling and ventilation considerations.

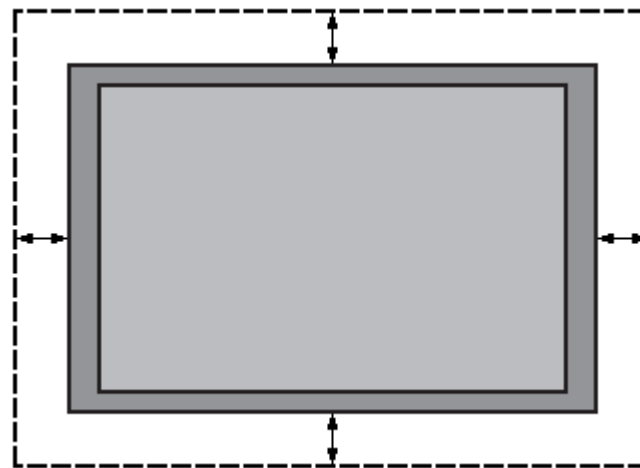

Single display

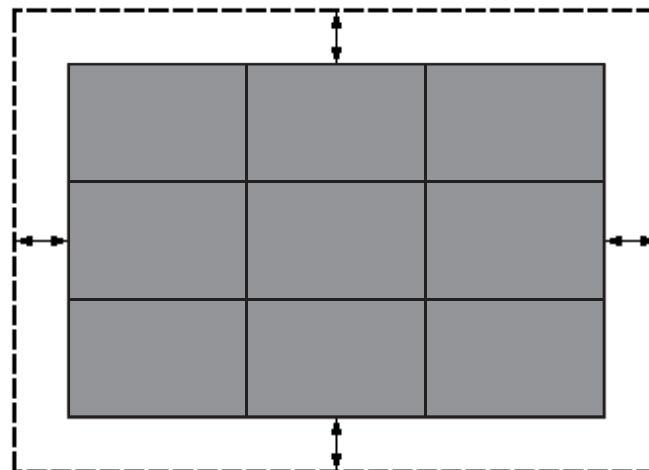

Video wall

When hanging from a ceiling

- Ensure that the ceiling is strong enough to support the LCD and its accessories. Earthquake, unexpected vibration and other external forces should be taken into consideration when evaluating the ceiling strength.
- The LCD should be secured to the building's structural frame such as a beam rather than light steel frame or interior decoration.
- Do not use wood screws or dry wall anchors for installation.

Maintenance

- Inspect the fasteners regularly for signs of loosening or deformation. Please perform appropriate corrective measures when a problem is identified. Neglecting the problem may worsen the situation.
- Increase the inspection frequency on areas where previous maintenance had occurred to ensure the problems do not occur again.

Wall Mounting

- A wall mount is not included. Please purchase a VESA Standard wall mount to secure the LCD. DynaScan is not responsible for damages caused by using non-standard wall mounts.
- Verify that the mounting location can support the weight of the LCD before installation.
- The installation angle must be within 15 degrees of the vertical axis.
- Do not install the wall mount while the power is turned on as it may cause serious injury from electrical shock

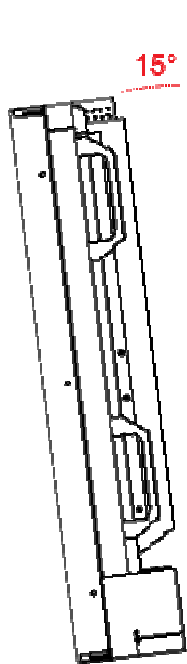

Connecting to a Power Source

Using the power cable provided, plug it in the power inlet on the back of the display shown in the diagram below. Connect the power cable to a 110-220 volt, 50 / 60Hz AC power outlet.



Insert the plug completely into the socket. A loose power connection may cause damage to the display and/or lead to a fire hazard.

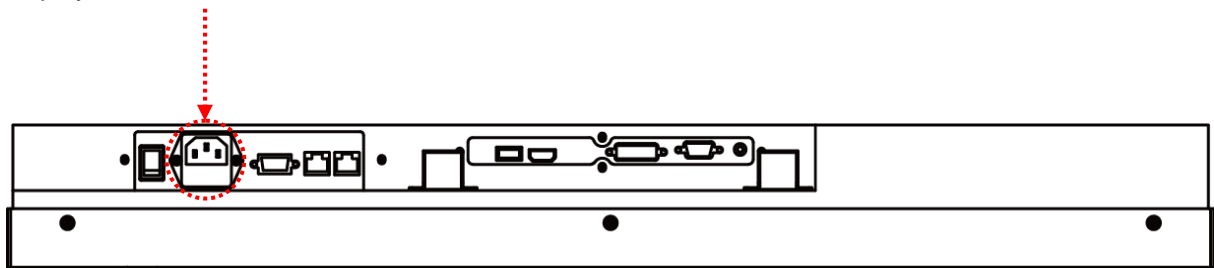

Connecting an External Video Source

Turn OFF the power of both LCD and external video device. Using the DVI cable (or HDMI cable) provided, insert one end into the DVI-IN (or HDMI-IN) on the back of the display shown in the diagram below. Connect the other end of the DVI cable (or HDMI cable) to the DVI output (or HDMI-output) of the video source. Refer to your video device's manual for additional information.

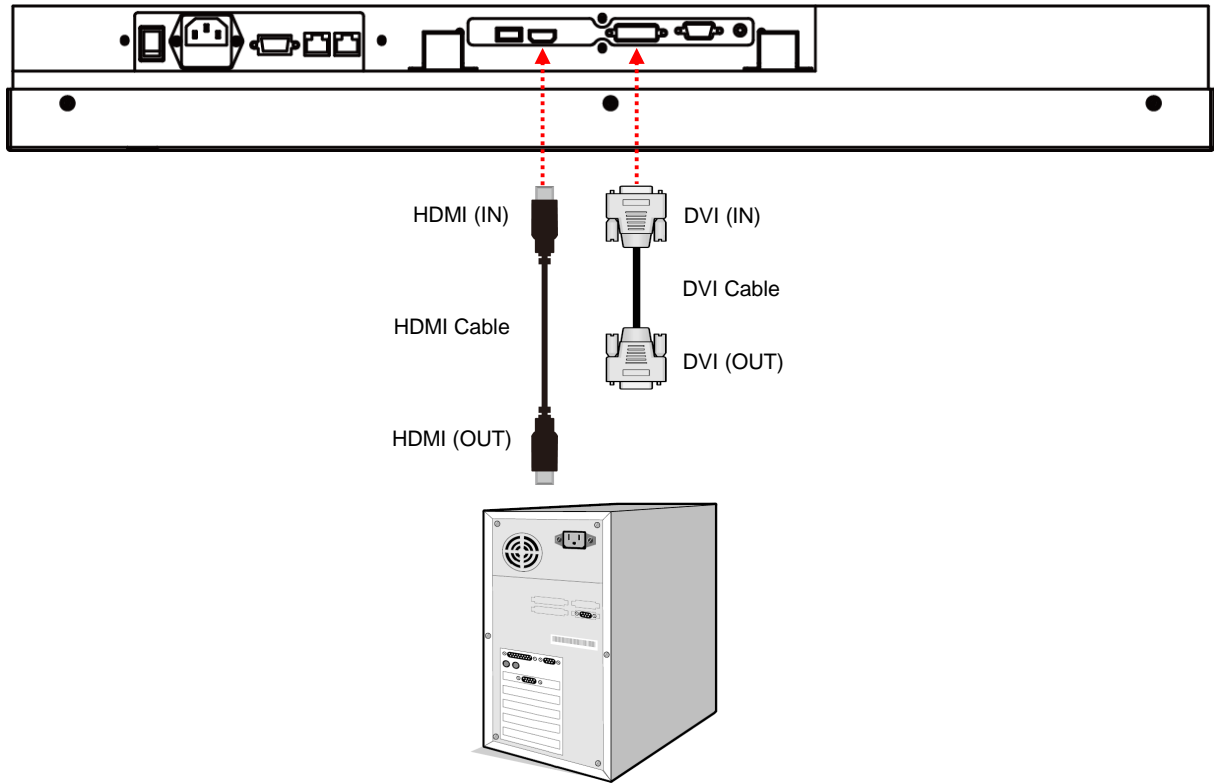

Connector Positions

①	②	③	④	⑤	⑥	⑦
Power Switch	AC (IN)	RS232 (IN)	RS485 (IN)	RS485 (OUT)	USB	HDMI (IN)

⑧	⑨
DVI (IN)	VGA (IN)

DS322LR4-1

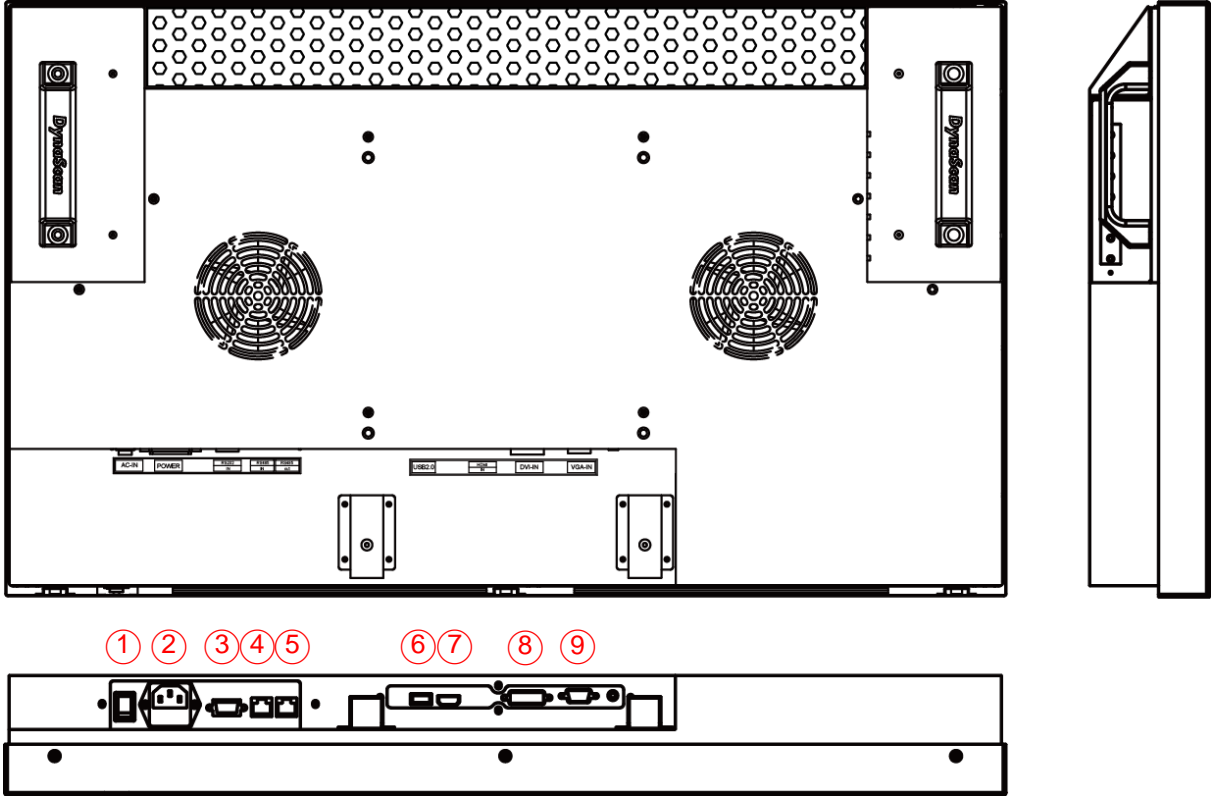

Input / Output Terminals

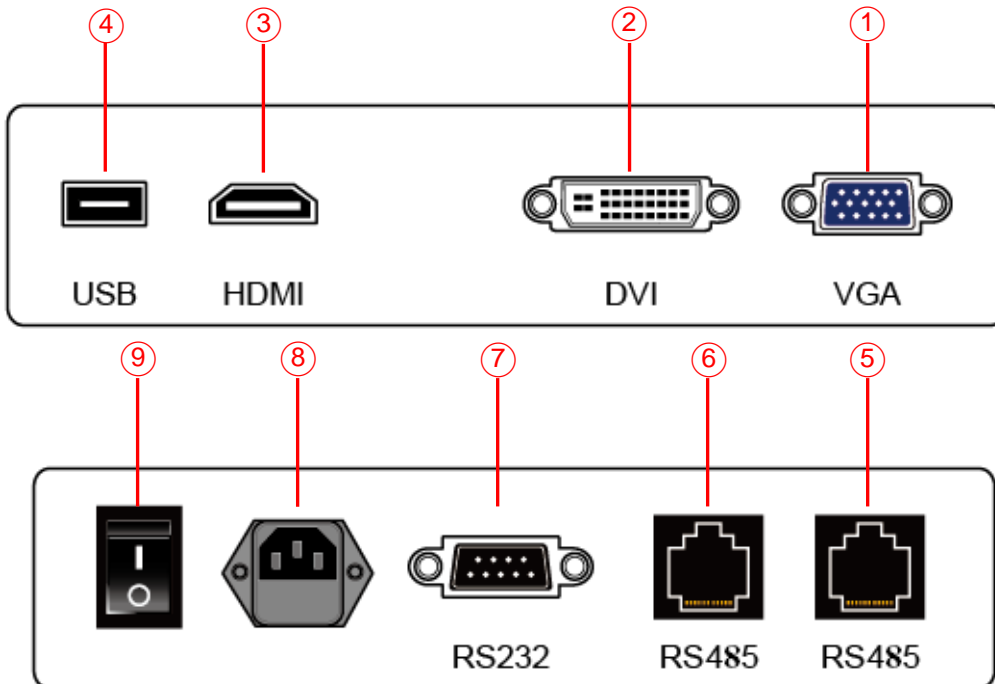

1. **VGA (IN):** Connect the VGA output of a PC, or an AV device by using a VGA cable.
2. **DVI (IN):** Connect the DVI-D output of a PC, or the HDMI output of an AV device by using a DVI-HDMI cable.
3. **HDMI (IN):** Connect the HDMI output of a PC, or an AV device by using a HDMI cable.
4. **USB:** USB can play content (photo, music, movie).
5. **RS485 (OUT):** RJ45 control function for the daisy chain application.
6. **RS485 (IN):** RJ45 network input connection for the use of remote control from computer.
7. **RS232 (IN):** RS232C network input connection for the use of remote control from computer.
8. **AC (IN):** Connect the supplied power cord to the wall outlet.
9. **Power Switch:** Press to switch the main power on/off.

Operating Instructions

Powering On/Off the Display

To turn on/off the display, press the power switch on the back of the display as shown in the diagram below.

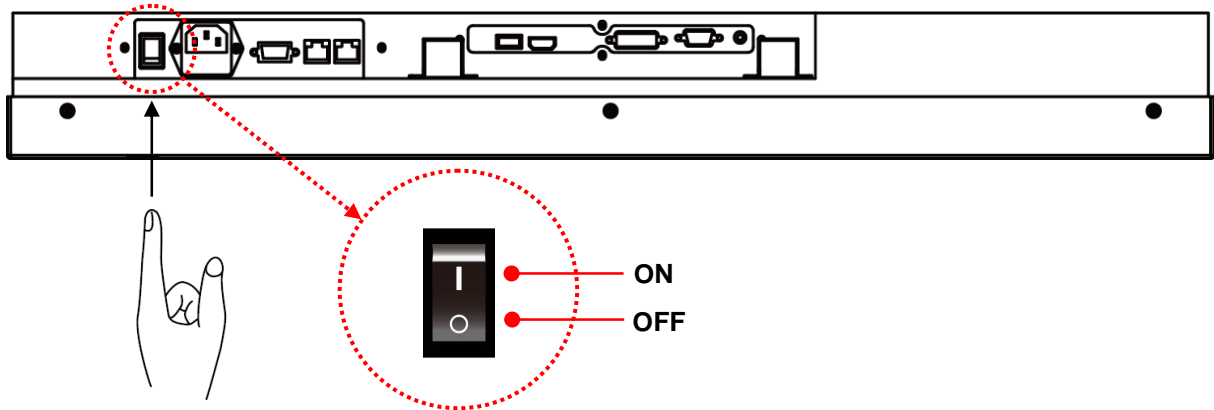

NOTE: The remote control only works when the power switch is ON.

Using the Remote Control

When using the remote control, aim the remote at the IR receiver on the display. The IR receiver on the DS322LR4-1 model is at the rear of the display with a receiving angle of 100 degrees. The IR receiver configurations of the model are shown in the figure below.

The operating range of the remote control is 2.5 meters (8 feet).

Ambient light may affect the performance of the remote control. Avoid fluorescent or neon lights in the vicinity.

DS322LR4-1

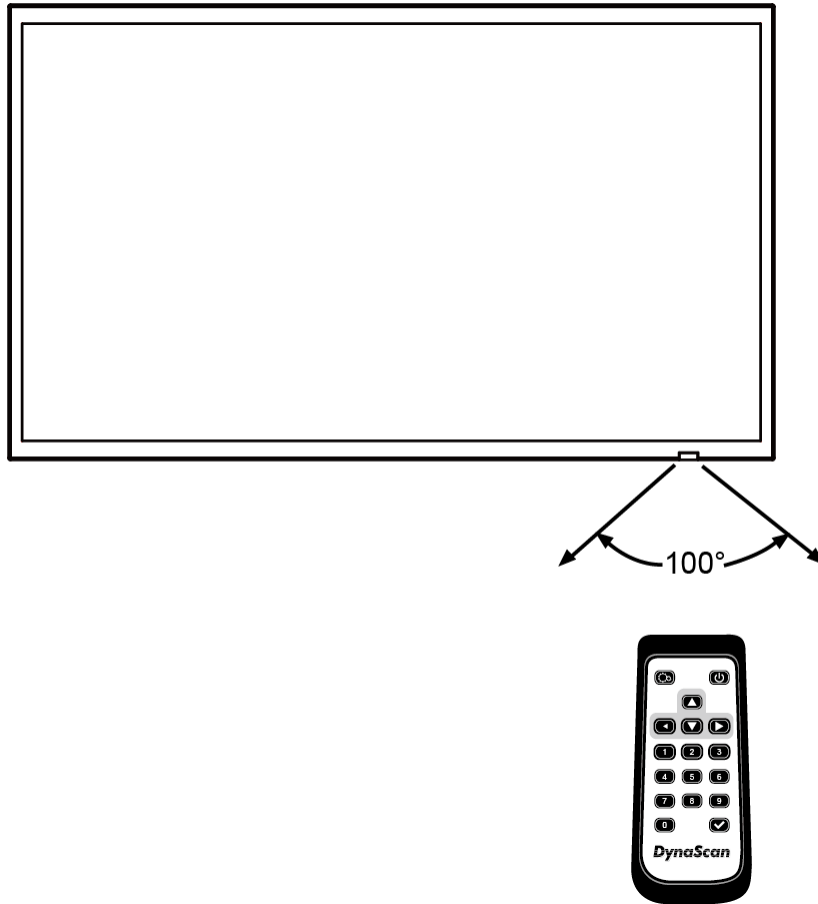

Using the Remote Control (cont.)

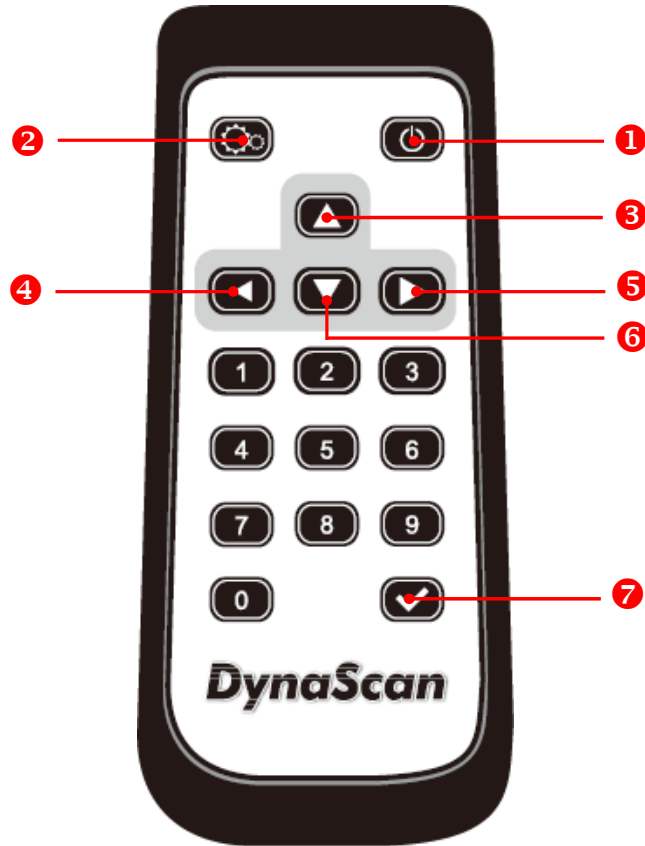

Color and shape may vary by model.

ITEM		DESCRIPTION
①	POWER	Power On / Off
②	MENU / EXIT	OSD On / Off and exit the current selection.
③	UP	Move the cursor up or change the setting of selected item.
④	LEFT	Move the cursor left or change the setting of the selected item.
⑤	RIGHT	Move the cursor right or change the setting of the selected item.
⑥	DOWN	Move the cursor down or change the setting of the selected item.
⑦	ENTER / INPUT	Select the highlighted item and input signal switching key.

Using the Rear Panel Controls

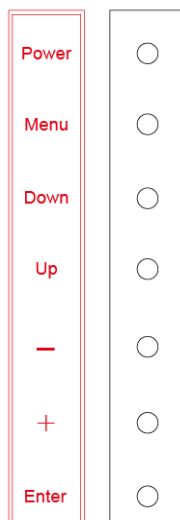
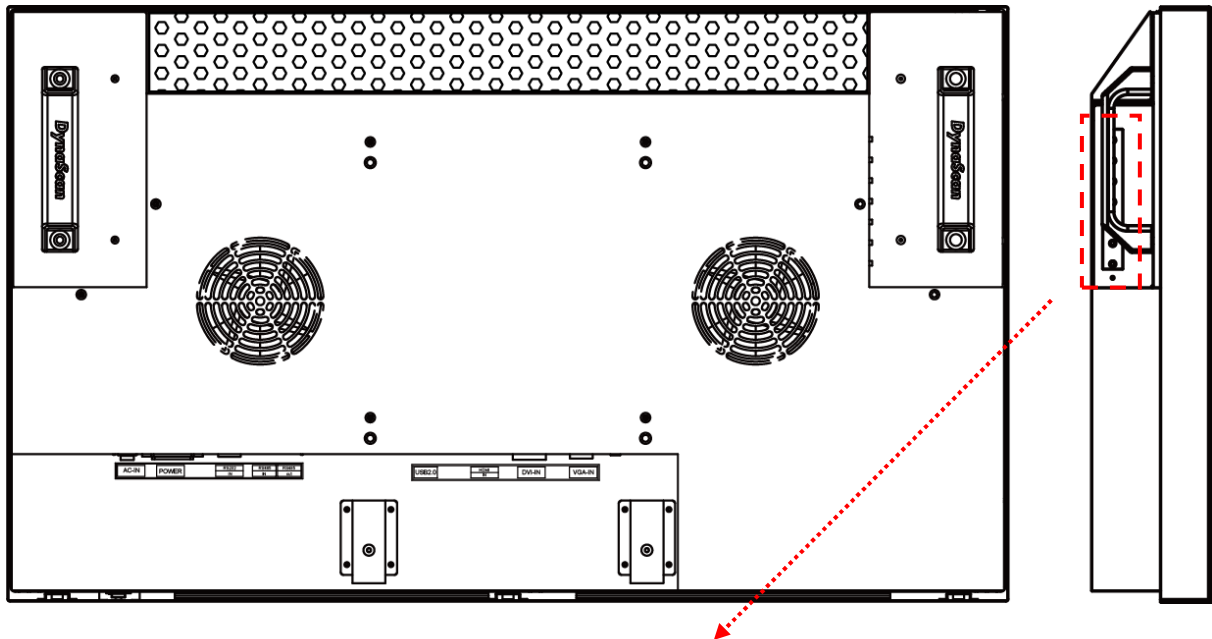

ITEM	DESCRIPTION
POWER	Power On / Off
MENU	OSD On / Off and exit the current selection.
DOWN	Move the cursor down or change the setting of the selected item.
UP	Move the cursor up or change the setting of the selected item.
—	Move the cursor left or change the setting of the selected item.
+	Move the cursor right or change the setting of the selected item.
ENTER	Select the highlighted item and input signal switching key.

Navigating the On Screen Display (OSD) Menu

Press the MENU button on either the rear panel control or remote control to show the OSD. Use the navigation arrows to select and adjust the menu items.

ITEM 1	ITEM 2	DESCRIPTION
Picture	Picture Mode	Set the picture mode. The options are: Standard, Dynamic, Soft, Personal.
	Color Mode	Set the color mode. The options are: Cool, Normal, Warm, Personal.
	Advanced	Set the advanced. The options are: H-Pos, V-Pos, Clock, Phase, Auto.
	Zoom Mode	Set the zoom mode. The options are: Normal, Full, Zoom, Cinema, Wide, Point to Point.
	Backlight	Adjusts the brightness level. Range 0 – 100.
	Color Range	Set the color range. The options are: AUTO, 0~255, 16~235.
	Light Sensor	Turn on / off light sensor function.
Setup	Menu Language	Set the language used in the OSD menu. The options are: English, French, Spanish.
	Transparent	Set the transparent used in the OSD menu. The options are: 0%, 25%, 50%, 75%, 100%.
	Restore Default	Restores all settings to default.
	Software Update (USB)	New version firmware update.
	FW ID	The firmware version.
	Monitor ID	Set the ID number for controlling the display via the RS232C connection. Each display must have a unique ID number when multiple sets of this display are connected.
APP	USB Media Player	Play video and audio files which stored in USB storage device. The options are: PHOTO, MOVIE.



Some functions may not be available for all input.

*Adjusted value: Each R/G/B value for this product has been individually adjusted in during production to a preset color mode of cool (6500K).

Specifications

MODEL		DS322LR4-1
PANEL	LCD Panel Size	31.55 inches
	Native Resolution	1920 x 1080
	Brightness	2500 cd/m ² (Typ.)
	Contrast Ratio	3,000:1 (Static) 10,000,000:1 (Dynamic)
	Response Time	12 ms (Typ.)
	Viewing Angle	178°/ 178°
	Life Time	50,000 hrs (Typ.)
	Panel Surface	AG Haze 1%, 3H
POWER	Power Supply	Internal
	Rated Voltage	100 ~ 240V, 50 / 60Hz
	Power On Mode	Typ. 120W / Max. 185W
	Standby Mode	< 5W
	AC Out	None
MECHANICAL SPECS	Bezel Width (T/B/L/R)	18.0/18.0/13.1/13.1 mm
	Cabinet Color	Black
	Monitor Dimension (LxHxD, w/o Stand)	727.5 x 432.0 x 87.0 mm
	Monitor Weight (set / package)	13.5 kg / 16.5 kg
	VESA Mounting (Dimension)	4 Holes (200x200 mm)
USER INTERFACE	OSD Language	English / French / Spanish
ENVIRONMENT	Operation Temperature	0°C ~ 40°C
	Storage Temperature	-20°C ~ 60°C
	Humidity	10%~80% RH Non-Condensing
I/O Ports	DVI-D	IN *1 (support HDMI)
	VGA	IN *1
	HDMI	IN *1
	RS-232	IN *1
	RS485	IN *1 / OUT *1
	USB	IN *1
Fuse		2.5A



Design and specifications are subject to change without notice.

Input Mode

Active Resolution		Refresh Rate	Pixel Rate	Aspect Ratio
H Pixels	V Lines			
640	480	60 Hz	25.175 MHz	4:3
720	480	59.94 Hz	27 MHz	4:3
800	600	60 Hz	40 MHz	4:3
1024	768	60 Hz	65 MHz	4:3
1280	720	60 Hz	74.25 MHz	16:9
1280	768	60 Hz	79.5 MHz	5:3
1360	768	60 Hz	85.5 MHz	16:9
1920	1080	60 Hz	148.5 MHz	16:9

Pin Assignments

Digital RGB Input (DVI-D): DVI

PIN ASSIGNMENT OF DVI CONNECTOR					
01	RX2-	09	RX1-	17	RX0-
02	RX2+	10	RX1+	18	RX0+
03	Shield (RX2 / RX4)	11	Shield (RX1 / RX3)	19	Shield (RX0 / RX5)
04	NC	12	NC	20	NC
05	NC	13	NC	21	NC
06	DDC-Serial Clock	14	+5V power	22	Shield (RXC)
07	DDC-Serial Data	15	Ground	23	RXC+
08	NC	16	Hot plug detect	24	RXC-

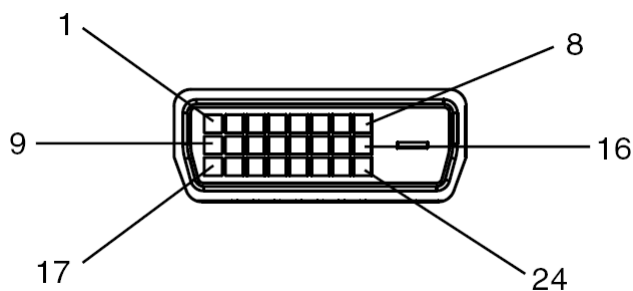

RS-232 Input

PIN No.	NAME
01	Connected to 7&8
02	TXD
03	RXD
04	Connected to 6
05	GND
06	Connected to 4
07	Connected to 1&8
08	Connected to 1&7
09	NC

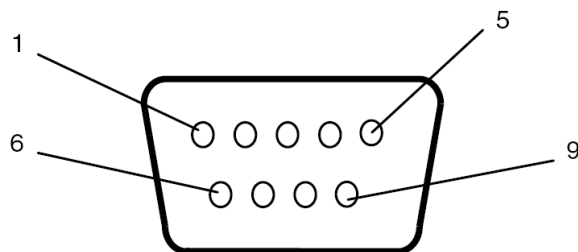

Troubleshooting

ISSUE	RECOMMENDED SOLUTION
No image is displayed.	<ul style="list-style-type: none"> • Check whether the DVI in cable (or HDMI in cable) is completely plugged in. • Check whether the main switch is in the ON position, and the power cord is completely plugged in. • Check whether the image source's resolution is set to 1920 × 1080 (1080p). • Check whether the DVI cable (or HDMI cable) is damaged or bent excessively. • Make sure that the correct input is selected and the cord to and from the player device is connected accordingly.
Nothing happens when switching the main switch on.	<ul style="list-style-type: none"> • Unplug the power cord from the socket and plug it in again after a few seconds to reset the Signage. Note: Unplugging the power cord will not change the settings.
Image is unstable.	<ul style="list-style-type: none"> • Check whether the DVI in cable (or HDMI in cable) is completely plugged in.
The remote control does not work.	<ul style="list-style-type: none"> • Check whether there are batteries in the remote control. • Check the batteries for freshness, polarity, etc. • Check whether the remote is in the operation range. • Bright light may interfere with the remote control. Please avoid using the remote control near special fluorescent lights or neon lights.
Cannot control the display remotely via RS-232.	<ul style="list-style-type: none"> • Check whether the RS-232 cable is connected properly.

If you are still having trouble with your DynaScan DS² Professional LCD, contact your dealer or DynaScan directly for more assistance.

www.dynascanusa.com