



DEHNventil®modular DV M TNC 255 (FM)

- DE Einbauanleitung
- GB Installation instructions
- IT Istruzioni di montaggio
- FR Instructions de montage
- NL Montagehandleiding
- ES Instrucciones de montaje
- PT Instruções de montagem
- DK Monteringsvejledning
- SE Monteringsanvisning
- FI Asennusohje
- GR Οδηγίες συναρμολόγησης
- PL Instrukcja montażu
- CZ Návod k montáži
- TR Montaj kılavuzu
- RU Инструкция по монтажу
- CN 安装说明
- HU Szerelési útmutató
- JP 設置説明書



I+II IEC 61643-11...  
1+2 EN 61643-11...

Pozidriv®Z2 7 Nm

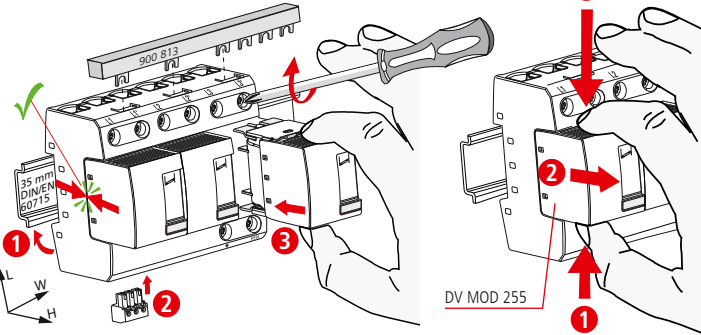

$U_N$	230 / 400 V (50/60 Hz) Tol.: 0V ... $U_c$
$U_c$	264 V (50/60 Hz)
$I_{th}^{(1)}$	50 kA <sub>rms</sub>
$I_{SCCR}$	50 kA <sub>rms</sub>
$I_{imp} 10/350 \mu s$	25 kA (L $\Rightarrow$ PEN); 75 kA (L1+L2+L3 $\Rightarrow$ PEN)
max. $\Rightarrow$ 2)	125 A gG
max. $\Rightarrow$ 3)	315 A gG
$\vartheta$	-40°C ... +80°C (... +60°C 2))
$I_{PE}$	<< 10 $\mu$ A
$\varphi$	5% ... 95%
IP 4)	20
L x W x H	90 mm x 108 mm x 73 mm

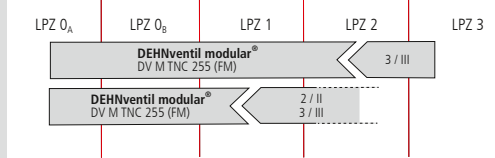

min. $\square$ L1, L1', L2, L2', L3, L3', PEN, $\downarrow$	10 mm <sup>2</sup>	
max. $\square$ L1, L2, L3, PEN	35 mm <sup>2</sup>	50 mm <sup>2</sup>
max. $\square$ L1', L2', L3', $\downarrow$	25 mm <sup>2</sup>	35 mm <sup>2</sup>
$\square$	16 mm <sup>2</sup> Cu	$\geq 15.5$ mm

2) TNC

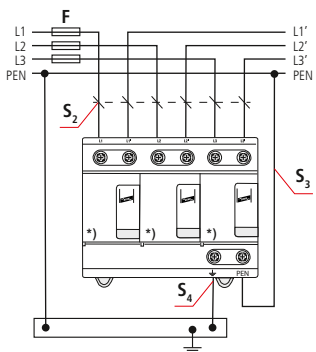

\*) DV MOD 255

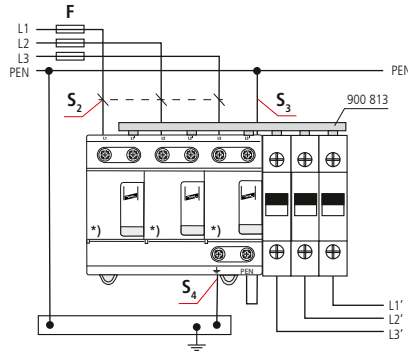

\*) DV MOD 255

DEHNventil modular DV M TNC 255 (FM)		F A gG	S <sub>2</sub> / mm <sup>2</sup>	S <sub>3</sub> / mm <sup>2</sup>	S <sub>4</sub> / mm <sup>2</sup>
F	F $\leq$ 125 A gG	25	10	16	16
	F > 125 A gG	35	10	16	16
		40	10	16	16
		50	10	16	16
		63	10	16	16
		80	16	16	16
		100	25	16	16
		125	35	16	16

F A gG	S <sub>2</sub> / mm <sup>2</sup>	S <sub>3</sub> / mm <sup>2</sup>	S <sub>4</sub> / mm <sup>2</sup>
25	10	16	16
35	10	16	16
40	10	16	16
50	10	16	16
63	10	16	16
80	16	16	16
100	25	16	16
125	35	16	16

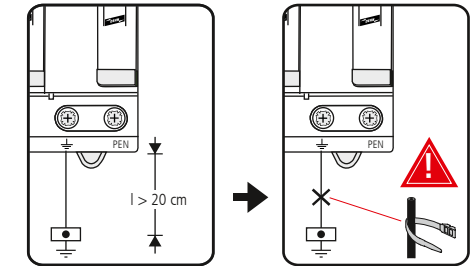

3) TNC

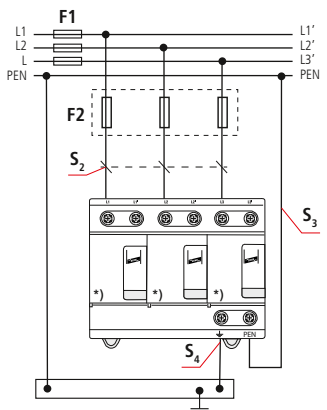

\*) DV MOD 255

DEHNventil modular DV M TNC 255 (FM)		F1 A gG	S <sub>2</sub> / mm <sup>2</sup>	S <sub>3</sub> / mm <sup>2</sup>	S <sub>4</sub> / mm <sup>2</sup>	F2 A gG
F1	F1 > 315 A gG	25	10	16	16	---
	F2 $\leq$ 315 A gG	35	10	16	16	---
		40	10	16	16	---
		50	10	16	16	---
		63	10	16	16	---
		80	10	16	16	---
		100	16	16	16	---
		125	16	16	16	---
		160	25	25	25	---
		200	35	35	25	---
		250	35	35	25	---
		315	50	50	25	---
		>315	50	50	25	315

$I_k \leq 100$  kA<sub>rms</sub>

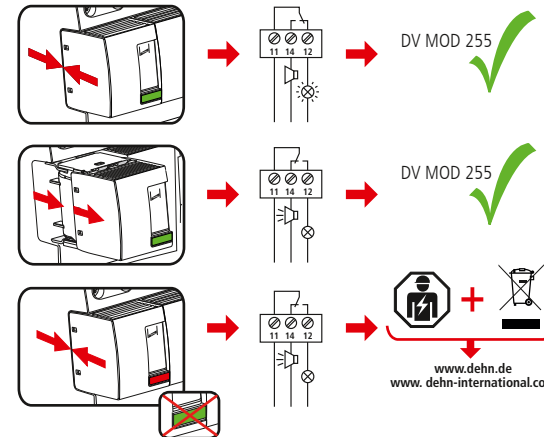

DEHNventil modular DV M TNC 255 FM		U <sub>N</sub> / I <sub>N</sub>
	AC: 250 V / 0.5 A	
	DC: 250 V / 0.1 A 125 V / 0.2 A 75 V / 0.5 A	
	max. 1.5 mm <sup>2</sup>	

