

ARGUS 42 *BASIC*

Manual

Version: 1.12 / **EN**

© **by intec Gesellschaft für Informationstechnik mbH**
D-58507 Lüdenscheid, Germany, 2012

Alle Rechte, auch der Übersetzung, vorbehalten. Kein Teil des Werkes darf in irgendeiner Form (Druck, Fotokopie, Mikrofilm oder einem anderen Verfahren) ohne schriftliche Genehmigung reproduziert, vervielfältigt oder verbreitet werden.

All rights are reserved. No portion of this document may be reproduced, duplicated or distributed in any form (print, copies, microfilm or on any other media) without intec's written permission.

1	Introduction	5
2	Safety Instructions	7
3	General Technical Data	8
4	Operating instructions	9
5	Menu Hierarchy	18
6	Operation on an ADSL Access	20
6.1	Setting the ADSL Interface and Access Mode	21
6.2	ADSL Settings	22
6.3	The ARGUS in the ATU-R Access Mode	28
	6.3.1 Determining the ADSL connection parameter	28
6.4	The ARGUS in the ATU-R Bridge Access Mode	34
	6.4.1 Displaying the Test Results	36
	6.4.2 Level measurement on an access	36
7	IP tests	37
7.1	Ping test	37
8	Test reports	45
8.1	Save test reports (Ethernet as an example)	45
8.2	Display results	46
8.3	Test reports – sending to a PC	47
8.4	Deleting test reports	48
8.5	Send all test reports to a PC	48
9	ARGUS Settings	49
9.1	Trace / remote	49
9.2	Device settings	50
9.3	Reset all parameters	52
10	Use of accumulators and battery packs	53
11	Firmware update	56

1 Introduction

Easy entry into the world of ADSL measurement technology: the inexpensive ARGUS 42 ^{BASIC} ADSL Tester offers impressive features such as quick availability and user-friendly testing of ADSL-over-POTS and ADSL-over-ISDN. The device is supplied with an IP ping function by default. The checker can optionally support a passive bridge mode.

Thanks to its easy handling, the ADSL Tester requires only few prior knowledge. All of the functions and tests can be quickly selected and started by pressing a softkey. The most important measurement results such as the up- and downstream data rates of the loop are displayed automatically. The handheld tester can also be configured easily via its alpha numeric keypad.

The ARGUS 42 ^{BASIC} is remarkably user-friendly thanks to its easy handling and quick availability. This handy tester weighs just 395 g and offers long operating times of several hours.

An overview of some important ARGUS functions:

Voltage measurement

Determines the connection parameters

Displays the connection's most important upstream/downstream parameters.

- maximum ATM bitrates
- fast or interleaved ATM bitrate
- signal-to-noise ratio
- output power
- line attenuation

Reads the error counters

Displays the upstream/downstream ATM cell errors and bit error statistics

- Cyclic Redundancy Check (CRC)
- Forward Error Correction (FEC)
- Header Error Checksum (HEC)

Ping test

Bridge mode

Access acceptance report

When the ARGUS is connected to a PC via USB, it is, as an example, possible - with the aid of the WINplus software - to create a comprehensive test report on the PC and print it.

Should you have any further questions, please contact us:

intec Gesellschaft für Informationstechnik mbH

Rahmedestr. 90
D-58507 Lüdenscheid
Tel.: +49 (0) 2351 / 9070-0
Fax: +49 (0) 2351 / 9070-70
www.argus.info/en
support@argus.info

2 Safety Instructions

The ARGUS may only be used with the included accessories. Usage of other accessories may lead to erroneous measurements and may even cause damage to the ARGUS and the connected installation. The ARGUS is only to be used in accordance with the instructions in this documentation. Any other usage may result in bodily injury and destruction of the ARGUS.



- Before connecting the ARGUS to an access make certain that the voltages on the access are not high enough to be dangerous or outside the specified range of the ARGUS or its accessories. You must also taken into account the fact that the voltage may vary while the ARGUS is connected to the access.
- Regardless of the interface or access, use the ARGUS only for its intended purpose.
- Voltages in excess of 50 V AC or 120 V DC can cause mortal injury.
- Never attempt a measurement if the battery pack is not inserted or the accumulators are not in place!
- The ARGUS is not watertight. Protect the ARGUS from exposure to water!
- Before replacing the accumulators or the battery pack, disconnect all the test leads and switch the ARGUS off.
CAUTION: Never remove the accumulators or the battery pack during operation.
- Unplug the power supply from the mains, once the ARGUS is switched off and will no longer be used (for example after recharging the accumulators)!
- The ARGUS may only be used by trained personnel.
- Do not operate the ARGUS on a power supply that has other specifications. The specifications are:
(Input: 100 V to 240 V AC; 50/60 Hz; 0.45 A)
(Output: 9 V DC; 0.56 A)
- The electromagnetic compatibility of the ARGUS was checked in accordance with the regulations stated in our Declaration of Conformity.
CAUTION: This tester is a Class A. product which may cause interference when operated in a residential area. In such case, the user must take appropriate measures.
- Do not plug anything into the serial jack (Ser.) except a USB serial adapter approved by the manufacturer; the use of this jack for any other application is expressly prohibited.
- If the ARGUS is operated under extreme conditions, it may have to automatically shutdown, terminate the current test and drop the connection in order to protect itself and the user.
- Do not open the tester.
- In connection with the additional NiMH battery pack, please observe the following notes regarding safety and transport.

Return and environmentally acceptable disposal

The RoHS (EU Directive on the "Restriction of Hazardous Substances") guidelines, which restrict the use of certain hazardous substances in electrical and electronic equipment, apply in eight of the ten categories of the WEEE (EU Directive on "Waste Electrical and Electronic Equipment") guidelines. Devices which are in Category 9 "Monitoring and Control Instruments" are currently excluded from the scope of the Directive. The ARGUS products fall into Category 9 and are thus not subject to the RoHS guidelines. Nonetheless, we have voluntarily complied with all of the RoHS guidelines since 1 January 2007. In compliance with WEEE (EU Directive on Waste of Electrical and Electronic Equipment) 2002/96/EU and the German Electrical and Electronic Equipment Act (ElektroG - Elektro- und Elektronikgerätengesetz), we began marking our testers in October 2005 with the following symbol:



() (DIN EN 50419).

In other words, the ARGUS and its accessories may not be disposed of in the household waste. Regarding the return of old equipment, please contact our Service department.

3 General Technical Data

Dimensions / Weight Height: 229 mm (9.02 in), Width: 72 mm (2.84 in), Depth: 35 mm (1.38 in), Weight: 350 g (0.77 lbs) (without accumulators and protective cover)	Inputs / Outputs - RJ-45 (Line) for ADSL - RJ-11 (Ser.) PC interface - RJ-45 10/100 Base-T (LAN) for bridge mode - Connector (PWR) for external Power supply
Keypad 21 Keys	Temperature ranges Operating Temperature: 0 °C (32 °F) to +50 °C (122 °F) Storage temperature: -15 °C (5 °F) to +70 °C (158 °F)
LCD display LCDdisplay with switchable Background lighting 4 lines with 16 characters	Power supply included NiMH standard accumulators or 9 V / 0.56 A ARGUS electronic plug-in power supply

4 Operating instructions

**Power Key:**

- Switch the ARGUS on
- To start up again after a power down
- To switch on the display backlighting
In battery mode, to save power, the backlighting will switch off automatically after 5 seconds.
- To switch off the ARGUS - must be pressed somewhat longer
If the ARGUS is connected to its power supply, the accumulators or battery pack will be automatically charged when the ARGUS is switched off (see page 53).

Confirmation key:

- Open menu
- Open the next display
- Start test
- Confirm the entry

Menu control:



- Scroll through displayed lines
- Select a menu



- Select a function or a test

Layer 1 Measurement:



- ADSL access: Display the line parameters

Keypad:



- Entry of the digits 0...9, letters and special characters
- Direct function call

Softkeys:



- The function of the 3 softkeys varies with the situation. The current function of each softkey is shown in the bottom, highlighted line of the display. Common softkeys and their meaning:
<MENU>: The main menu will open.
<START>: Setup a connection or start a test
You will find the other softkeys described at the relevant points in the manual.

The ARGUS is in largest part operated with the two ↓-, ↑-Keys, the confirmation key  and the three softkeys. On the following pages, only the softkey's meaning in the respective context is shown - enclosed in angle brackets < >, e.g. <ADSL>.

The softkeys <✓>, <↓> and <↑> perform the same functions as the confirmation key



and the arrow keys



and



on the ARGUS keypad.

Connections at bottom:



PWR

Connection for the external plug-in power supply. If the plug-in power supply is connected, the ARGUS will disconnect the accumulators and, when it is switched off, the ARGUS will automatically recharge the accumulators (see page 53).

Line

ADSL connection Pin assignment 4/5

Ser.

Serial interface to connect a PC

LAN

Connection to the PC's network card via patch cable (Access mode: ATU-R Bridge).

Start-Up

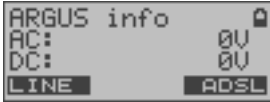

Using the included cable, connect the ARGUS to the access to be tested. Press the  key to switch the ARGUS on.

Start-Up Display

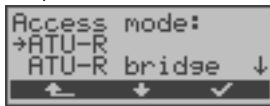

- <ADSL> ARGUS starts the ADSL connection
- <LINE> The ARGUS opens the Access menu.



- Access Mode Menu:**
- <↓> or  or  Select the Access mode
The selected access mode will be marked in the display with an → (in the example, ATU-R).
 - <✓> or  The ARGUS will use the marked access mode.
 - <↑> To have the ARGUS return to the previous display.





- ARGUS – State display**
- On an ADSL access, the ARGUS will display the DC voltage on the line.
- <MENU> Open the Main menu
 - <START> Setting up an ADSL connection, see page 29.
 - <NEW> The ARGUS will open the Start-Up display. Hold the softkey depressed for 2 seconds.

Main menu

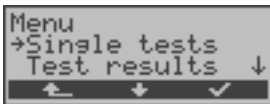
All of the menus, which are available for the type of access under test, are listed in the Main menu



- <↓> or  or  to select a menu.
The selected menu will be marked in the display with an → (in the example, Single tests)
- <✓> or  to have the ARGUS open the menu marked with the → (in the example, Test results).
- <↑> to return to the previous display (in this example, ARGUS State)

Starting functions with the numeric keys/key combinations

Using the numeric keys, you can start important ARGUS functions/tests directly, regardless of the menu that the ARGUS is currently showing. If a function is called where the ARGUS expects the entry of a digit, pressing a number key will be interpreted as the expected input.



The assignment of functions to the numeric keys can also be viewed on the ARGUS display. Open the Main menu and select "Help".

The ARGUS will display the "assignment" of the numeric keys.

Operation on an ADSL (Access mode: ATU-R)

Numeric key 0	Display ARGUS Status
Numeric key 1	Show the "Function assignment" on the ARGUS display
Numeric key 3	Start a Ping test



Display the Line status

One after the other Quick access to the Access mode menu

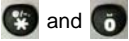

One after the other Display the available SW options

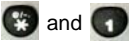

One after the other Reset all the parameters to their default values.

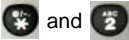

The PPP user name, PPP password, IP addresses, Profile names and all of the test results stored in the ARGUS (e.g. ADSL test results etc.) will be deleted.



Charging the accumulators for the first time

The battery compartment for the three accumulators (rechargeable batteries) are located on the back of the case. Unscrew the screws to remove the cover of the case and insert the accumulators in accordance with the polarity marking. Use only the accumulators included in the package. With the ARGUS switched off, connect it to the supplied plug-in power supply.

Press the -key to switch the ARGUS on. The following will be shown on the display:

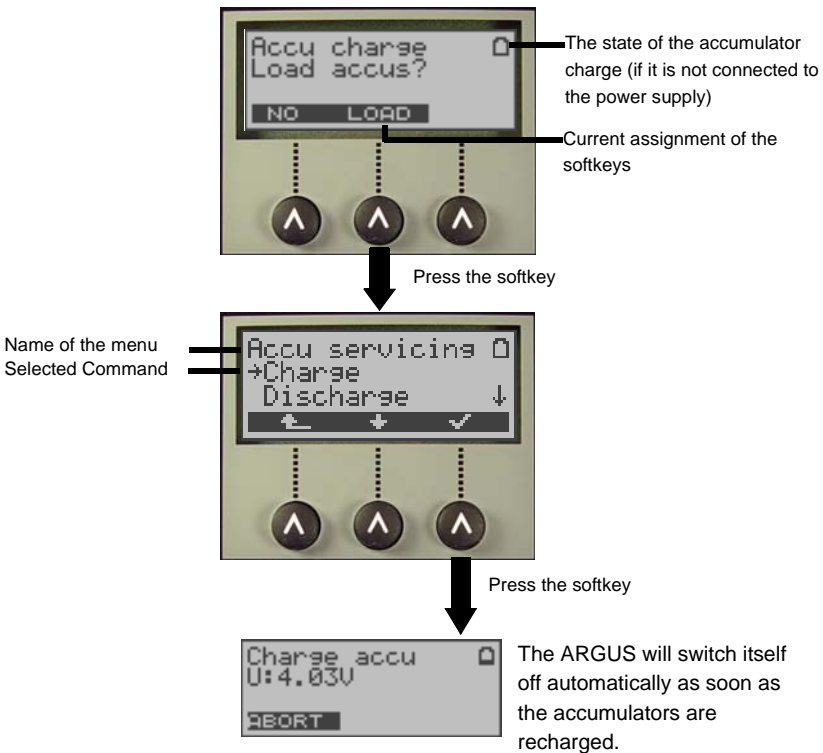

The accumulators supplied must be fully charged and discharged three times (see page 54 Charge accus) before they will achieve their maximum capacity.

Power Management

In accu/battery operation, if the ARGUS is idle for 5 minutes (default), it will automatically switch to the power-down mode (power-down). The ARGUS will remain in power-down mode until the Power-Key is pressed again. Reasonably enough, the ARGUS will not enter power-down mode during a test (e.g. Loopbox) or when it is in Trace mode.

As an alternative, it is possible to operate the ARGUS using the included power supply. If the ARGUS is connected to the plug-in power supply, it will automatically disconnect the accumulators and will not enter power-down mode. You should only operate the ARGUS with the accumulators installed. This will ensure among other things the uninterrupted operation of the real-time clock.

Power Management settings:

If desired, the settings recommended for the times may be changed. In this case, the settings for the automatic power-down and for the display lighting may be set separately. Settings under: "Menu\Configuration\Device\Power management"



Caution! If you change the recommended (default) settings, this may lead to shorter battery operation!

An Overview of the ARGUS Connections

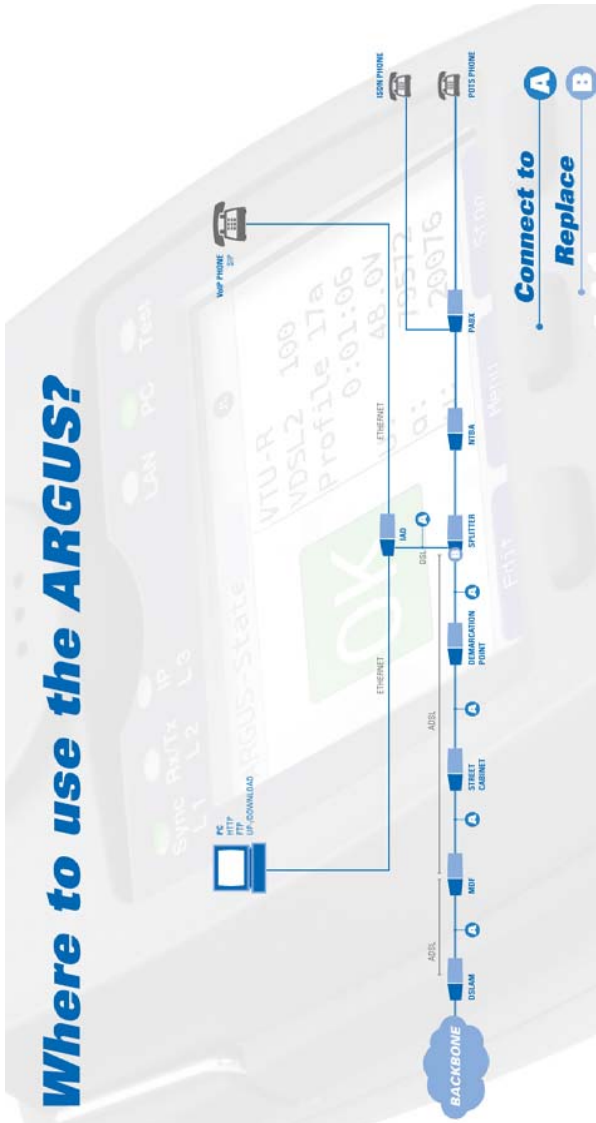

5 Menu Hierarchy

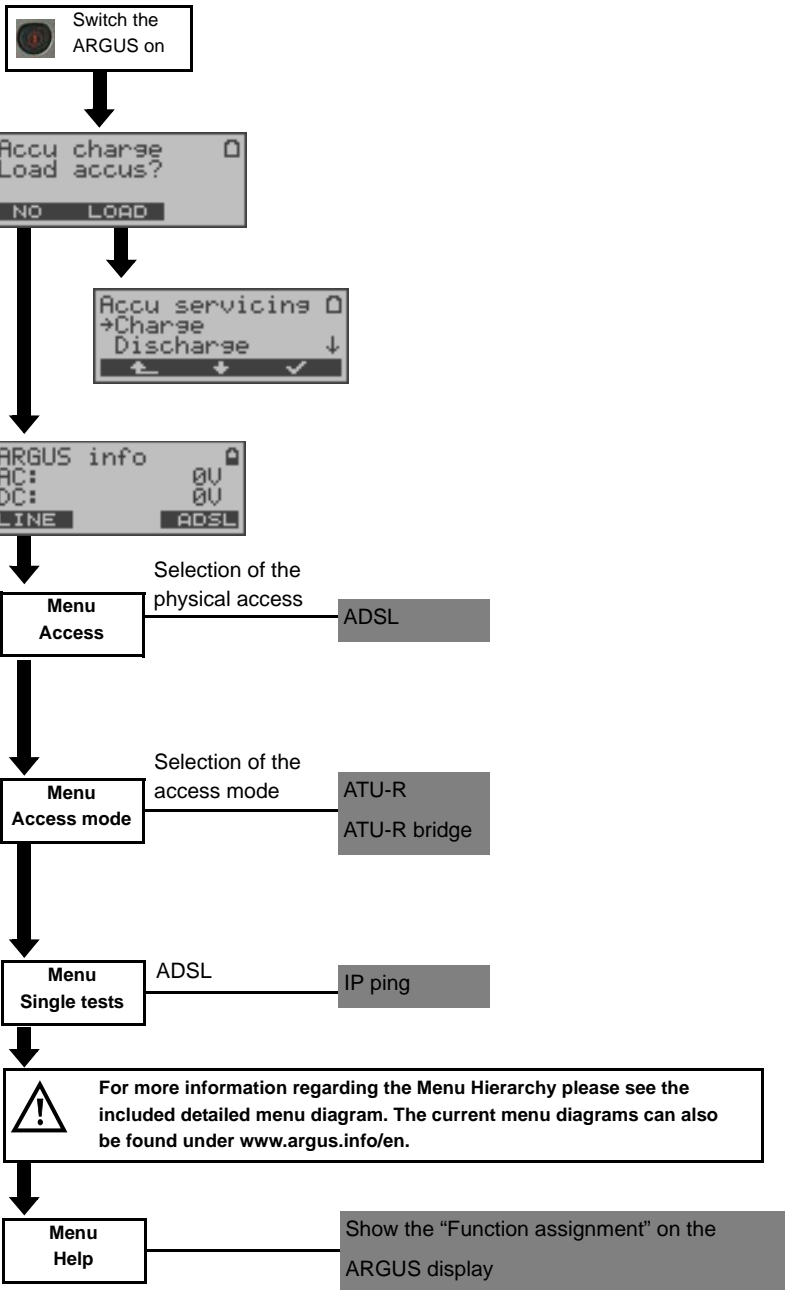

6 Operation on an ADSL Access

The ARGUS supports the following types of access (access modes):

ATU-R Terminal mode (ADSL Transceiver Unit Remote) see page 28.
Connection of the ARGUS directly to the ADSL access (before or after the splitter). The ARGUS replaces both the modem and the PC.

ATU-R Bridge Bridge mode (ADSL Transceiver Unit Remote Bridge) see page 34.
Insertion of the ARGUS between the ADSL access and the PC. The ARGUS replaces the ADSL modem.



The individual tests record and store data. The user must comply with the statutory regulations governing the collection and storage of such data and his obligation to give notice in this connection.

6.1 Setting the ADSL Interface and Access Mode

Using the original ARGUS cable, connect the ARGUS to the access to be tested and then switch the ARGUS on.

```

ARGUS info
AC:          0V
DC:          0V
LINE        ADSL
  
```

```

Access mode:
→ATU-R
  ATU-R bridge ↓
←      ↓      ✓
  
```

The Access mode menu is not selectable from the Main menu. It opens automatically once the ADSL physical access has been selected.

ATU-R see page 28

ATU-R Bridge see page 34

```

ARGUS
ATU-R
Voltage:    72.3V
NEW MENU START
  
```

ARGUS State display

The ARGUS displays the access mode and the DC voltage on the access interface.

The ADSL connection is not yet set up!

```

Menu
→Single tests
  Test results ↓
←      ↓      ✓
  
```

ARGUS Main menu

see page 12

6.2 ADSL Settings

The ARGUS stores all of the parameters required to run a test (determination of the ADSL connection parameters, ping test) on an ADSL access in a profile. Up to 10 user-defined profiles can be created. A profile must be selected before an ADSL test is run. Only those parameters which are relevant will be used for the respective test situation.

The default settings can be restored at any time (see page 52). The procedure for configuring a parameter is the same for all parameters and will be illustrated with a single example:

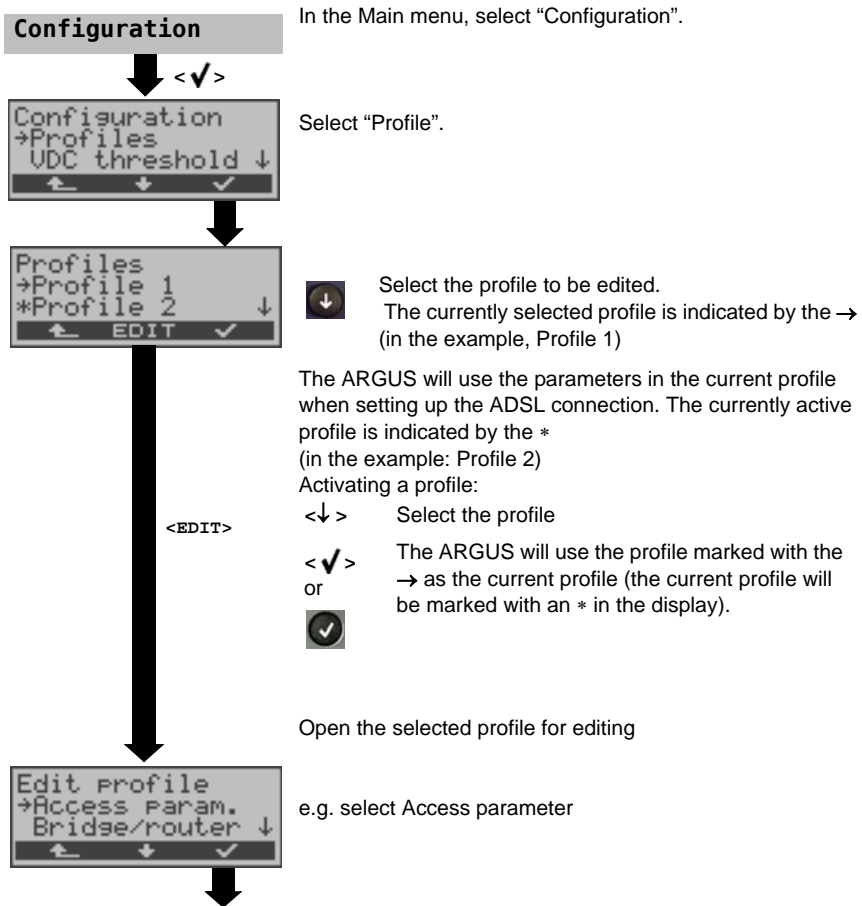

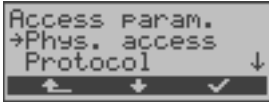

e.g. select Physical Access

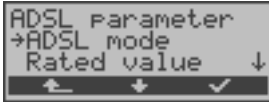

e.g. select ADSL mode

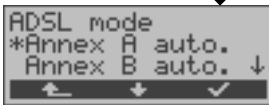



Select the desired ADSL mode.

< ✓ > The ARGUS will now store this setting in the profile.

< ↶ > The ARGUS will return to the previous display without saving the selected setting.

Setting	Explanation
Access parameters	
Phys. access	
ADSL parameter	
ADSL mode	Different ADSL modes can be selected depending on the national variant of the ARGUS. The selected ADSL mode must be compatible to ATU-C (network-side). If the ADSL mode „Annex A/M auto“ or „Annex B/J auto“ is selected, the ARGUS will automatically determine the configuration of the DSLAM (G.DMT or ANSI) and set itself accordingly. Default setting: dependent on the national variant
Rated values	Use the keypad to enter the upstream and downstream comparison values for the ATM bitrate [kbit/s]. If the current bitrates on the ADSL connection exceed the rated values, the ARGUS will display "OK“, otherwise it will display "FAIL“. Default setting: d: 0 and u: 0

Protocol:	<p>Selection of the transfer protocol that the ARGUS should use for the test (e.g. for an IP test).</p> <p>Protocols for ADSL: PPPoE (PPPoEoA) - Point-to-Point Protocol over Ethernet PPPoA - Point-to-Point-Protocol over ATM EoA (IPoE, IPoEoA) - Ethernet over ATM IPoA - Internet Protocol over ATM Default setting: PPPoE</p>
ATM:	Settings for Asynchronous Transfer Mode
VPI / VCI	<p>VPI: Enter Virtual Path Identifier VCI: Enter Virtual Channel Identifier Ranges: VPI: 0 to 127, VCI: 32 to 255 Default setting: VPI: 1 and VCI: 32</p>
Encapsulation	<p>Selection of the encapsulation of the packets to be sent (LLC or VC-MUX). Default setting: LLC</p>
MAC / VLAN:	MAC (Media Access Control) and VLAN (Virtual Local Area Network)
MAC address	<p>Display and selection of the MAC addresses. The first two MAC addresses cannot be changed. If the default MAC address is selected, the Argus will use its own MAC address. If Dynamic MAC Address is select a different MAC address will be used for each synchronization. Default setting: Default MAC Address A third MAC address can be entered: Mark a line and then press <Edit>.</p> <p style="padding-left: 40px;"><Edit> Enter the address in hexadecimal using the keypad and the softkeys <A..F> (e.g. to enter a "C" press the softkey three times or to enter an "F" six times, then finish up by pressing <OK> to confirm your entry). Default setting: 00:00:00:00:00:00</p> <p style="padding-left: 40px;"> Use the address. The new address is only saved temporarily and will not be available when the ARGUS is switched on again.</p>

VLAN	Use VLAN:	Specifies whether or not VLAN should be used: yes or no. Default setting: No
	ID:	Identifier for the VLAN to which the frame belongs. Every VLAN is assigned a unique number, the VLAN ID. A device, which belongs to the VLAN with the ID = 1, can communicate with every other device in the same VLAN, but not with a device in other VLANs (one with an ID other than 1, i.e. 2). Range: from 0 to 4095 Default setting: 0
	Priority:	User - priority information: An eight-level (3 bits) priority can be assigned to each frame. In this manner, it is possible e.g. to give priority to forwarding voice data (in the case of VoIP), while HTTP data will be handled as a lower priority. Range: 0 to 7 Default setting: 0
PPP:	PPP (Point- to-Point Protocol) settings	
User name	Entry of the user name assigned (by the network operator)	
		Use the keypad to enter the user name. When the right softkey is pressed it assumes a different meaning and thus influences the entries made from the keypad (letters or digits), page 31.
Password	Entry of the password assigned by the network operator: (see above)	
Set the IP	If "Yes", the IP address entered as own IP address will be used for the connection. Default setting: No	
Activation delay	After setting up the PPP connection, the ARGUS will first wait until the period specified in the "activation delay" has elapsed before beginning a test. Range: 2 to 10 seconds Default setting: 2	

IP:	Internet Protocol setting (for EoA)
IP mode	Setting the assignment of the IP addresses Static IP: fixed IP addresses DHCP client: IP address assigned by the server (remote end) Default setting: DHCP client
local IP	own local IP address of the ARGUS Range: 0.0.0.0 to 255.255.255.255 Default setting: 0.0.0.0 (see RFC 3330 regarding assignment)
IP netmask	IP netmask Range: 0.0.0.0 to 255.255.255.255 Default setting: 255.255.255.0 (see RFC 3330 regarding assignment)
Gateway IP	Gateway IP address Range: 0.0.0.0 to 255.255.255.255 Default setting: 0.0.0.0 (see RFC 3330 regarding assignment)
DNS server	DNS server 1 and DNS server 2 Entry of the IP address of the Domain Name System server Range: 0.0.0.0 to 255.255.255.255 Default setting: 0.0.0.0 (see RFC 3330 regarding assignment)
DHCP client	DHCP timeout (setting of how long to wait for the IP address): Range: 1 to 9999 seconds Default setting: 20
	DHCP vendor ID: - Format: Selection of the format: ASCII or hexadecimal - ASCII data: Enter the DHCP vendor ID in ASCII format Default setting: ARGUS , operation see page 25 - HEX data: Enter the DHCP vendor ID in hexadecimal format For instructions, see MAC address page 24.
	DHCP vendor info: - Format: Selection of the format: ASCII or hexadecimal - ASCII data: Enter the DHCP vendor info in ASCII format Default setting: ARGUS , operation see page 25. - HEX data: Enter the DHCP vendor info in hexadecimal format (for instructions, see MAC address) page 24.

	<p>DHCP user class information</p> <ul style="list-style-type: none"> - Format: Selection of the format: ASCII or hexadecimal - ASCII data: Enter the DHCP user class i. in ASCII format Default setting: ARGUS, operation see page 25. - HEX data: Enter the DHCP user class information in hexadecimal format (for instructions, see MAC address) page 24. <p>DHCP user-defined option (Create a user-defined DHCP option)</p> <ul style="list-style-type: none"> - Option number Range: 0 to 255 Default setting: 255 = off - Format: Selection of the format: ASCII or hexadecimal - ASCII data: Entry of the DHCP userdef. option in ASCII format Default setting: ARGUS, operation see page 25. - HEX data: Enter the DHCP user-defined option in hexadecimal format (for instructions, see MAC address) page 24.
Bridge / Router	
Auto-negotiation	<p>On or off: If autonegotiation is enabled, a network card can independently determine the correct transmission speed and duplex setting for the Ethernet port to which it is connected and configure itself accordingly.</p> <p>In the case of Ethernet, autonegotiation is based on layer 1 of the OSI Model (in accordance with the IEEE 802.3u standard).</p> <p>Default setting: on</p>
Test parameters	The test parameters are described in the chapters on IP tests.
Data Log	<p>Data Log on or off: This setting must be "on" in order to send a trace file to a PC, see page 45.</p> <p>Default setting: off</p>
Use Profile	<p>To set the profile to be used.</p> <p>Yes: use this profile and display it in the profile list.</p>
Profile name	Enter the name of the profile

6.3 The ARGUS in the ATU-R Access Mode

6.3.1 Determining the ADSL connection parameter

Using the xDSL connection cable (consisting of the xDSL cable and the xDSL adapter), the ARGUS is connected directly to the ADSL access (either before or after the splitter). In this case, the ARGUS replaces both the modem and the PC.



Use only the cable included in the package!

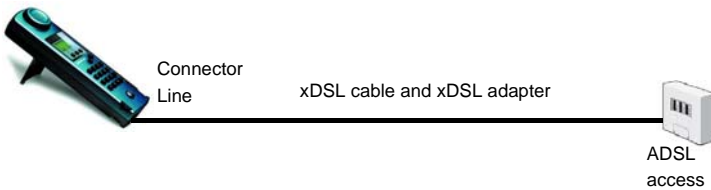

The ARGUS uses the access parameters stored in the profile when setting up the connection (see page 23).



The ARGUS may need a few seconds to record all of the parameters. To be certain that all of the parameters have been recorded, simply examine the Bits/Tone or SNR/Tone graphs. If the ARGUS can display these, it must have also recorded all of the rest of the parameters.

If the test is terminated too early (right after synchronization), it is possible that some of the important parameters will not be included in the test report.

Setting the ATU-R access mode:

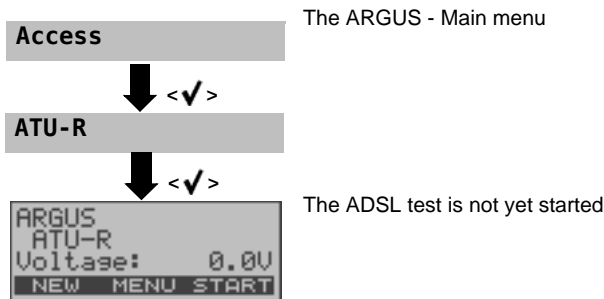

Setting Up an ADSL Connection

The ARGUS will set up an ADSL connection and determine all of the relevant ADSL connection parameters. The ARGUS displays the connection parameters and saves them after the connection is cleared down if desired.

```
ARGUS
ATU-R
Voltage: 72.3U
NEW MENU START
```

Setting up an ADSL connection from the Status display. In this case, the access mode must first be selected in the Access mode menu (see page 21). In this example, "ATU-R".

Initializing the hardware

Initialization

```
ARGUS
ATU-R
GHS
MENU STOP
```

The ARGUS synchronizes with the DSLAM (the "L1 Sync" LED will flash). The ARGUS will display the current modem state.

<STOP> Cancel setup



```
Modem full init.
0:00:23
Annex A auto.
← TRACE
```

The ARGUS displays the current modem state, the setup time (in the example: 23 seconds) and the ADSL mode.

< ↑ > The ARGUS will return to the previous display

<TRACE> Command symbols:

- < = command sent from the ARGUS
- > = command sent from modem
- = modem status

<TIME> Display showing when the commands arrive.

Once the connection has been setup ("L1 Sync" LED on constantly), the ARGUS will determine the ADSL connection parameters.

Connection successfully setup

Once the ADSL connection has been setup (“L1/Sync” LED on constantly), the ARGUS will determine and display the ADSL connection parameters.

Once the ARGUS has successfully synchronized, the error counters will be reset to zero. After the ARGUS has synchronized, please leave it connected to the ADSL access for at least another 20 seconds since the ADSL connection parameters are first available to be stored in the ARGUS after this period of time.



Display of the downstream and upstream bit rates. The ARGUS will display an OK if the bit rate achieved is greater than the target value set (see page 23). Otherwise, it will display a FAIL.

- <MENU> The ARGUS will open the Main menu.
- <STOP> Clear down the ADSL connection



The ARGUS will display the ADSL mode, the duration of the connection (Elapsed) and the ADSL connection parameters.

↓, ↑ - Keys Display the ADSL connection parameter see table page 32.

<TRACE> Display the commands and modem state.



Reset the error counters: FEC, CRC, HEC
CAUTION: Once showtime has been reached, the ARGUS will automatically reset the error counters.



Display bit distribution e.g. bits transported per carrier frequency (tone).
y-axis: bits per carrier frequency (tone)
x-axis: tones (carrier frequencies)

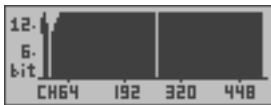

Based on the bit distribution, it is possible to detect line disturbances (e.g. HDB3, HDSL, RF etc.)

Press any softkey



Display of the signal-to-noise ratio for each tone
y-axis: SNR in dB
x-axis: tones (carrier frequencies)
Shows interference or noise by frequency.

Press any softkey



Display of the quiet line noise (QLN) for each tone The QLN is measured once before synchronization (it is not checked continuously) and can be examined after synchronization.

y-axis: QLN in dBm/Hz
x-axis: tones (carrier frequencies)
Detection of disturbances on the line.

Press any softkey

```

Showtime
Act.t.: 0:00:25
ADSL2+ Annex A ↓
← TRACE GRAPH

```

Close the results display.

```

OK | kbit/s:
   | d:16.000
   | u: 1.024
MENU STOP

```

Clear down the ADSL connection.

```

Save
result?
NO IP>PC YES

```

<IP>PC>:

The ARGUS will send the trace file to the connected PC, which must be running WINplus. The data will be saved in the "*.log" format and can be renamed to "*.pcap" and decoded with a freeware program (such as Wireshark). The setting "Data Log" must be set to "on". In bridge mode, two log files will be loaded to the PC, one for the WAN and one for the LAN side.

Save the results (see page 45).

```

save as:
AMP_5
ABORT DEL 3b>AB

```

The ARGUS will save the test results in the first free record. This record can be assigned any name (default: AMP_1, AMP_2, AMP_3, etc. If all of the records have been written, you must manually select a memory location (record). A record name can be entered using the numeric keypad. When the right softkey is pressed it assumes a different meaning and thus influences the entries made from the keypad:

- <12>ab> Entry of the digits 0 to 9 plus * and #
- <ab>AB> Entry of the lowercase characters and @, /, -, .
(e.g. to enter a "c" press the "2" on the keypad three times).
- <AB>12> Entry of the uppercase characters and @, /, -, .
- Delete the character before the cursor
- ↓, ↑ - Keys Move the cursor
- <START> Set up an ADSL connection again



```

ARGUS
ATU-R
Voltage: 0.0V
NEW MENU START

```

The ARGUS will determine the following ADSL connection parameters downstream (d:) and upstream (u:):

ADSL Connection Parameters	
Target value comparison	The target value, which was set for the bit rate, is compared with the rate actually achieved (see page 23).
ATM	The actual useable ATM bitrate in kbit/s.
Attain. ATM	This is the theoretically attainable bitrate in kbit/s.
Rel.capacity	Utilization of the line as a percentage.
Latency mode	Depending on the configuration of the DSLAM, the ARGUS will display either Interleaved or Fast mode.
Attenuation	The line's attenuation in dB over its entire length.
Output PWR	Output power in dBm.
SNR margin	The signal-to-noise margin in dB; the SNR margin is a measure of how much additional noise the transmission can withstand and still achieve a BER (Bit Error Rate) of 10^{-7} .
Interl. Depth	The interleave depth in bytes Interleaving is a procedure that arranges the data transmitted in a non-contiguous order and is used to protect the data transmission against impulse noise (burst errors).
INP	The Impulse Noise Protection (INP) is an indicator of the quality of the protective mechanism as far as impulse noise is concerned. The number of DMT symbols, which can be completely distorted in succession, without an error occurring on the higher layers.
FEC Forward Error Correction	The FEC shows the number of transmission errors corrected using the ATM cell checkbytes. In upstream (far) and downstream (near): f (far): Errors that the DSLAM has detected and informed the ARGUS. n (near): Errors which were detected by the ARGUS in the blocks it received.

CRC Cyclic Redundancy Check	The super-frame checksum sent from the opposing end does not match the one calculated locally. Possible cause: Fault on the line. In upstream (far) and downstream (near): f (far): Errors that the DSLAM has detected and informed the ARGUS. n (near): Errors which were detected by the ARGUS in the blocks it received.
HEC Header Error Checksum	The HEC shows the number of ATM cells with bad header checksums. In upstream (far) and downstream (near): f (far): Errors that the DSLAM has detected and informed the ARGUS. n (near): Errors which were detected by the ARGUS in the blocks it received.
Err. Count. Reset	Shows how often the error counters have been reset.
Resync	Number of times that the ARGUS has been resynchronized.
Vendor far	The manufacturer of the ATU-C side shown as hexadecimal number.
Version	Vendor Specific Information, generally shows the version of the software running at the ATU-C (DSLAM) end.

6.4 The ARGUS in the ATU-R Bridge Access Mode

In Bridge mode, the ARGUS acts like an ADSL modem, i.e. the ARGUS passively passes all packets from the Ethernet interface to the ADSL access (and vice versa). In this case, the PC is responsible for setting up the connection.

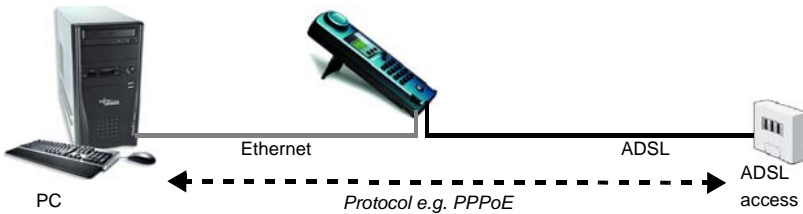

Setting the parameters:

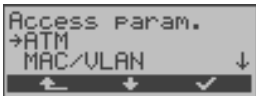

In addition to the physical parameters, Bridge mode also requires that the two following ATM parameters (connection parameters) are configured:

- VPI / VCI (page 24)
- Encapsulation (page 24)

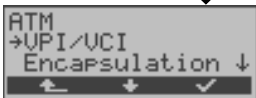

ADSL connection in Bridge mode:



ATU-R bridge

In the Access mode menu, select "ATU-R Bridge".



Set up an ADSL connection.

```

ARGUS
ATU-R bridge
Initializing
MENU STOP

```

The ARGUS will first synchronize itself with the DSLAM. Afterwards, it will initialise the software. While the ARGUS is attempting to set up the ADSL connection, the "L1 Sync" LED will flash.

```

Linemode
Active!
Elapsed:0:03:09
← ADSL STAT.

```

Once the connection has been setup ("L1 Sync" LED on constantly), the ARGUS will determine the ADSL connection parameters. The ARGUS display how long it has been in Bridge mode.

<STAT.> Display the statistics.

<PHYS.> Display the physical parameters.

```

ADSL:          ETH:
d:17692kb      -Mb
u: 1181kb
← ADSL ETH

```

Displayed when the ADSL connection has been set up: ADSL mode and duration of the ADSL connection



Display the ADSL connection parameters (see the table on page 32).

<ADSL> ADSL connection parameter.

<ETH> Display the Ethernet Phys. Parameters.

<TRACE> Display the commands and modem states.

```

Showtime
Akt.Z.: 0:00:23
ADSL2+ Annex B ↓
← TRACE GRAPH

```

<GRAPH> Bit distribution display: Display of the signal-to-noise ratio for each tone.

Display of the quiet line noise (QLN) for each tone.

When the connection is being cleared down, you will be prompted as to whether the results should be saved (see page 30).

6.4.1 Displaying the Test Results

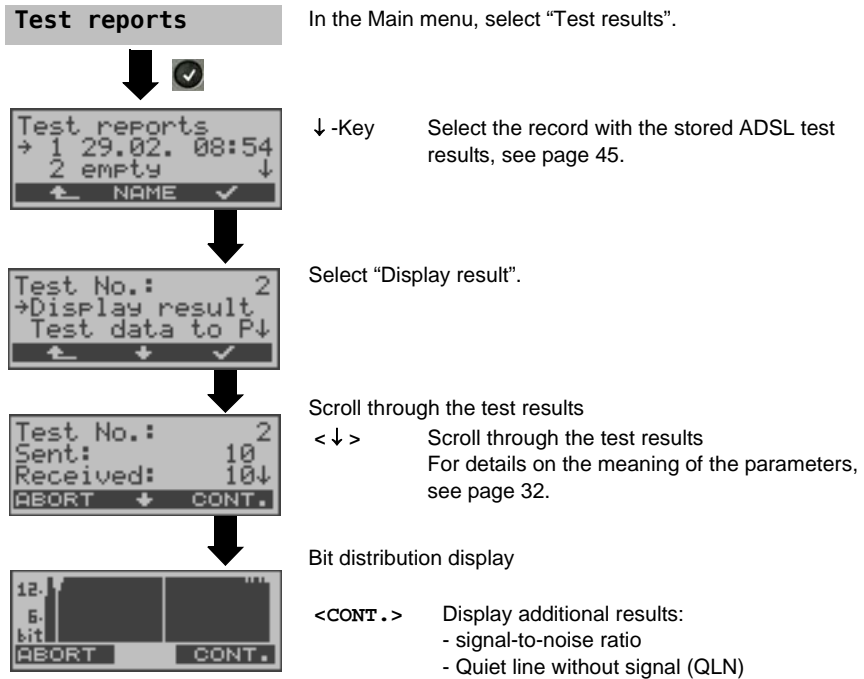

6.4.2 Level measurement on an access

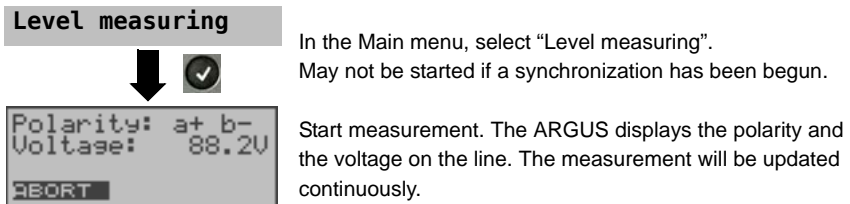

7 IP tests

7.1 Ping test





In a Ping test, the ARGUS checks whether it is possible to setup a connection to an Internet Service Provider (ISP) via the DSLAM and ATM/IP network:

The ARGUS sends a test packet to a predefined IP address (remote site) and then waits for a packet in reply. Based on the received packet, it is possible to evaluate the ATM/IP network availability and delay. It is also possible to determine the network's maximum data packet size.

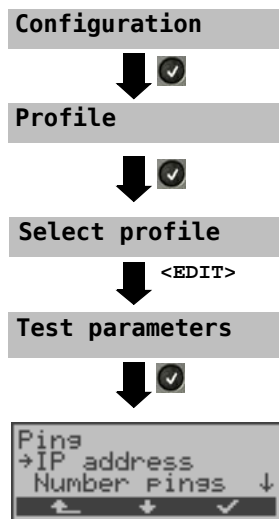
The following parameters (see page 38) are required for the Ping test:

Protocol independent parameters



Test parameters	
IP address	This is the address of the remote site. The ARGUS can save up to 3 IP addresses. The saved IP addresses are available to all of the profiles.
 <p>The ARGUS shows the memory locations (a total of three) available for storing IP addresses. Use the cursor keys to mark the memory location with the IP address that you wish to edit (in this example, the first memory location is marked (1/3).</p> <p>as name:</p>  <p><Edit> Open the marked IP address to edit it.</p>  <p><√> The address can be entered as an IP address (number) or as a name.</p> <p>Enter the name of the IP address. Entry using the numeric keypad. Use the softkey on the right to shift the keypad (the softkey on the right assumes a different meaning when pressed), page 31.</p>  <p><√> Set the marked IP address as the default address.</p>	
Number of pings	Enter the number of test packets that the ARGUS should send to the IP address. If you enter a zero ("0"), the ARGUS will send packets continuously until the test is stopped manually. Range: 1 to 99,999 Default setting: 10
Delay	This setting determines the amount of time that the ARGUS will wait between sending test packets. Range: 0.1 to 9.9 seconds Default setting: 1 second
Packet size	This setting determines the size of the test packets. By varying the size, it is possible to determine the maximum data packet size and the relationship between size and response time. Range: 36 to 55,555 bytes Default setting: 84 bytes

Fragmentation	This parameter sets the fragmentation: Default setting: on	
	on	Depending on the network (or router), test packets may be divided into multiple packets.
	off	Fragmentation is not permitted, i.e. the test packets may be rejected by the network (or router). In this case, the ARGUS will not receive a packet in reply.
	auto	The ARGUS determines the maximum packet size for the path to the destination address (Path-MTU) and splits the test packet into smaller packets. These can then be sent with the minimum of delay (since the network/router need not fragment the test packet).

Protocol-dependent parameters on an ADSL access:

Protocol	PPPoE (PPPoEoA) or PPPoA	IPoA / EoA (or also IPoE)
Access parameter	ATM - VPI / VCI - Encapsulation	ATM - VPI / VCI - Encapsulation
	PPP - User name - Password - Set the IP - Activation delay	
	ADSL mode	ADSL mode
		IP - IP mode - local IP - IP netmask - Gateway IP - DNS server - DHCP client
	MAC / VLAN (in the case of PPPoE) - MAC address - VLAN	MAC / VLAN (in the case of EoA) - MAC address - VLAN

Start a ping test:



Access Mode: ATU-R
 Set up an ADSL connection.
 The profile used to set up the ADSL connection will also be used for the Ping test.



Single tests

The ARGUS will open the Main menu.



Depending on the protocol and access:
 The ARGUS will first display the user name stored in the profile for the PPP connection.
 The user name can, however, be changed (see page 25).



If the user name is changed here, it will only be placed in temporary storage; the profile itself is not modified.

If you change the user name, you must enter the password again (see page 25).



If the password is changed here, it will only be placed in temporary storage; the profile itself is not modified.



The password will remain visible during entry. It will not be masked until you have confirmed your entry.

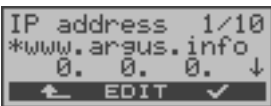

The ARGUS displays the IP address stored in the profile.



To select the IP address for the ping.
 (The default address is marked with an “*”)

<EDIT>

Opens the IP address for editing.
 (see page 22).



```

Ping test
Initializing
ABORT ADSL

```

Initializing the test software
(If it has not yet been done, set up an ADSL connection).

Displayed when the ADSL connection has been set up:
ADSL mode and duration of the ADSL connection

```

Showtime
Act.t.: 0:00:25
ADSL2+ Annex A ↓
← TRACE GRAPH

```



Display the ADSL connection parameters,
see table page 32

<TRACE>

Display the commands and modem state.

<GRAPH>

Bit distribution display

Display of the signal-to-noise ratio for each
tone

Display the Quiet Line Noise (QLN) for each
tone.

< ↵ >

The ARGUS will open the Status display.

Press the <STOP> softkey in the Status
display to clear down the ADSL connection.

Ping test

```

Ping test
Sent: 6
Received: 5
ABORT ADSL

```

The Ping test will start automatically.

The ARGUS will display the current number of test packets
sent and number of packets received in response.

Depending on the access mode and protocol, the LAN,
WAN, PPP and ATM statistics will also be displayed (scroll
through with the ↓-key).

<ADSL>

Display the ADSL connection parameters, the
duration of the ADSL connection

<ABORT>

The test will be cancelled, the ARGUS will
display the results collected thus far and will
inquire whether to save them.

Ping results

```
Ping test
Sent:      10
Received:  10↓
← ADSL NEW
```



```
Ping test
Repeated:  0
CS Error:  0↓
← ADSL NEW
```



```
Ping test
Error:      0
Min [ms]:  1.1↓
← ADSL NEW
```



```
Ping test
Max [ms]:  18.1
Avg [ms]:  3.8↓
← ADSL NEW
```



```
Linemode
Active!
Elapsed:0:03:09
← ADSL STAT.
```



Switch to Line mode

<stat.> Depending on the access mode and protocol, the ARGUS will display the BRAS, IP, PPP, WAN, ATM or LAN statistics.

```
Linemode
BRAS AC Name:
DTMR72-se800-B2↓
← PPP
```



BRAS information:
The ARGUS displays (for the PPPoE protocol only) the BRAS (Broadband Remote Access Server) information:
- AC (Access Server) name of the server
- Service name

```
Linemode
Assigned IP:
10.67.15.163↓
← PPP
```



Assigned configuration:
The ARGUS will display the IP configuration assigned by the server:
- IP address assigned
- Gateway IP address
- DNS server available

Once the test is over, the ARGUS will display the results:

- Number of packets sent
- Number of packets received
- Number of packets sent again
- Checksum errors
- Number of faulty packets received
- Minimum packet round-trip delay
- Maximum packet round-trip delay
- Average packet round-trip delay
- Assigned WAN IP
- statistics

<ADSL> Display the ADSL connection parameters, the duration of the ADSL connection
<NEW> Start a new ping test

```

Linemode
PPP Packets:
Rx: 15 Tx: 15↓
← PPP

```



```

Linemode
ATM Cells:
Rx: 263↓
← PPP

```



```

Linemode
<PPPoE PADI sent
>PPPoE PADO rec↓
← TIME

```

**PPP information:**

The ARGUS will display the number of PPP packets and bytes received (Rx) and sent (Tx).

WAN Ethernet:

The ARGUS will display the number of Ethernet frames and bytes received (Rx) and sent (Tx).

ATM Cells:

The ARGUS will display the number of ATM cells received (Rx) and sent (Tx).

ATM Information:

The ARGUS will display the ATM information received (Rx) and sent (Tx) such as

- Number of OAM cells
- Number of user-side VCCs
- Number of AAL5 PDUs (ADSL only)
- Received (Rx) unmapped cells
- Received (Rx) unmapped VPI
- Received (Rx) unmapped VCI

<PPP>

Press the <PPP> softkey to display a PPP trace showing the sequence of PPP messages.

Command symbols:

- < = command sent from the ARGUS
- > = command, sent from the remote site
- PADI: PPPoE Active Discovery Initiation
- PADO: PPPoE Active Discovery Offer
- PADR: PPPoE Active Discovery Request
- PADS: PPPoE Active Discovery Session confirmation
- PADT: PPPoE Active Discovery Termination
- LCP: Link Control Protocol
- IPCP: Internet Protocol Control Protocol
- PAP: Password Authentication Protocol

<Time>

The <Time> softkey is used to tag the individual messages with times from the ARGUS system clock.

```
Ping test
Save
result?
NO IP>PC YES
```

<IP>PC>:

The ARGUS will send the trace file to the connected PC, which must be running WINplus. The data will be saved in the "*.log" format and can be renamed to "*.pcap" and decoded with a freeware program (such as Wireshark). The setting "Data Log" must be set to "on". In Bridge mode, two log files will be loaded to the PC, one for the WAN and one for the LAN side.

```
save as:
AMP_5
ABORT DEL 3b>AB
```

Save the test results in the internal Flash memory.

```
Menu
→Test results
Line status ↓
← ↓ ✓
```

The ARGUS will save the test results in the first free record. This record can be assigned any name (default: AMP_1, AMP_2....). If all of the records have been written, you must manually select a memory location (record).

```
Ping test
Error:
No PPP connec.
← ADSL NEW
```

Ping Test – Error messages

If an error occurs, the ARGUS will stop the test and display an error message.

<NEW> Start a new Ping test

For a description of the error messages, please see the appendix.

8 Test reports

8.1 Save test reports (Ethernet as an example)



ARGUS – State display

Stop ADSL connection



<IP>PC:

The ARGUS will send the trace file to the connected PC, which must be running WINplus. The data will be saved in the ".log" format and can be renamed to "*.pcap" and decoded with a freeware program (such as Wireshark). The setting "Data Log" must be set to "on". In Bridge mode two log files will be loaded to the PC, one for the WAN and one for the LAN side.

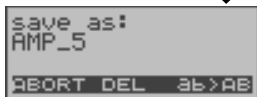

The ARGUS will save the test results in the first free record.

This record can be assigned any name (default: AMP_1, AMP_2....). If all of the records have been written, you must manually select a memory location (record).

A record name can be entered using the numeric keypad. When the right softkey is pressed it assumes a different meaning and thus influences the entries made from the keypad:

- <12>ab> Entry of the digits 0 to 9 plus * and #
- <ab>AB> Entry of lowercase characters and @, /,- and .
- <AB>12> Entry of uppercase characters and @, /,- and .
- Delete the character before the cursor
- ↓ -, ↑ -Keys Move the cursor



Save the results



Once the results have been successfully saved in memory, the ARGUS will return to the State display. A new test can be started by pressing <start>.

8.2 Display results

The ARGUS displays the saved test results. Using the WINplus software, the test results can also be saved on a PC. WINplus can be used to generate a comprehensive measurement report from these results.

The ARGUS saves the test results of various test runs together with the date and time (from the internal clock of the ARGUS) in memory locations with sequential record numbers 1, 2, 3, ... The results are not lost when the ARGUS is switched off.

Each function in the Test results menu involves at least one record. The selections "All tests to PC" and "Deleted all" affect all records. Therefore, the first step will open a dialog in which you must select the desired data record.

Test reports

In the Main menu, select "Test reports".



```

Test reports
→ 1 AMP_2
   2 empty
← DATE ✓
    
```

Use the cursor keys to select the record (saved test results). The ARGUS will also display the associated name or the corresponding date and time for each record number. Empty records are labeled as "empty".



```

Test reports
→ 1 29.02. 08:54
   2 empty
← NAME ✓
    
```

<NAME> Display the record names, e.g. AMP_2, ...
or
<DATE> Display the date and time



```

Test No.: 1
→Display result
  Test data to P↓
←   ↓   ✓
    
```

8.3 Test reports – sending to a PC

Using the included "USB serial adapter", data records can be transferred from the serial interface of the ARGUS ("Ser.") to a PC (USB interface) where these test results can be visualized and archived. Connect the ARGUS to your PC and start the ARGUS WINplus program.

Test reports

In the Main menu, select "Test results".



```

Test reports
→ 1 29.02. 08:54
  2 empty
←  NAME  ✓
  
```

↓-key Select the record (saved test results)



```

Test No.:            1
→ Test data to PC
Delete
←   ↓   ✓
  
```

Select "Test data to PC".

Start transfer of
data to PC

8.4 Deleting test reports

Test results

In the Main menu, select "Test results".



```
Test reports
→ 1 29.02. 08:54
  2 empty
←  NAME  ✓ ↓
```

↓ -key Select the record (saved test results)



Select "Delete"

```
Test No.:      1
→Delete
All tests to P↓
←   ↓   ✓
```

Delete the selected record (in the example, no. 1).
A deleted record will be shown as "empty".



To delete all of the test results, select "Delete all".

```
Test reports
→ 1 empty
  2 empty
←   ✓ ↓
```

8.5 Send all test reports to a PC

The ARGUS sends all of the saved test results to the PC.

Test results

In the Main menu, select "Test results".



```
Test reports
→ 1 AMP_2
  2 empty
←  DATE  ✓ ↓
```

↓ -key Select the record (saved test results)



Select "All tests to PC".

```
Test No.:      1
→All tests to PC
Delete all
←   ↓   ✓
```

Start transfer of data
to PC

9 ARGUS Settings

The ARGUS can be configured to suit your special requirements. The default (factory) settings can be restored by selecting "Reset". (see page 52 Reset all parameters).

9.1 Trace / remote

The ARGUS remains active and passes the data from the D-channel (all of the D-channel messages sent to and received from the network) or DSL trace data online directly to the connected PC running the optional WINplus/WINanalyse software.

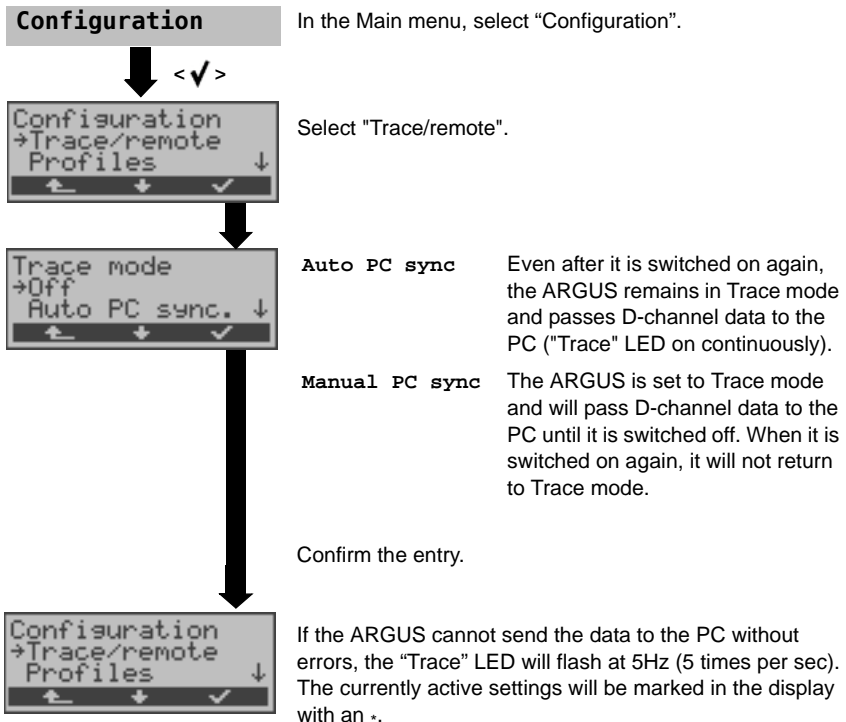

9.2 Device settings

The procedure for configuring a parameter is the same for all device parameters and will be illustrated with a single example:

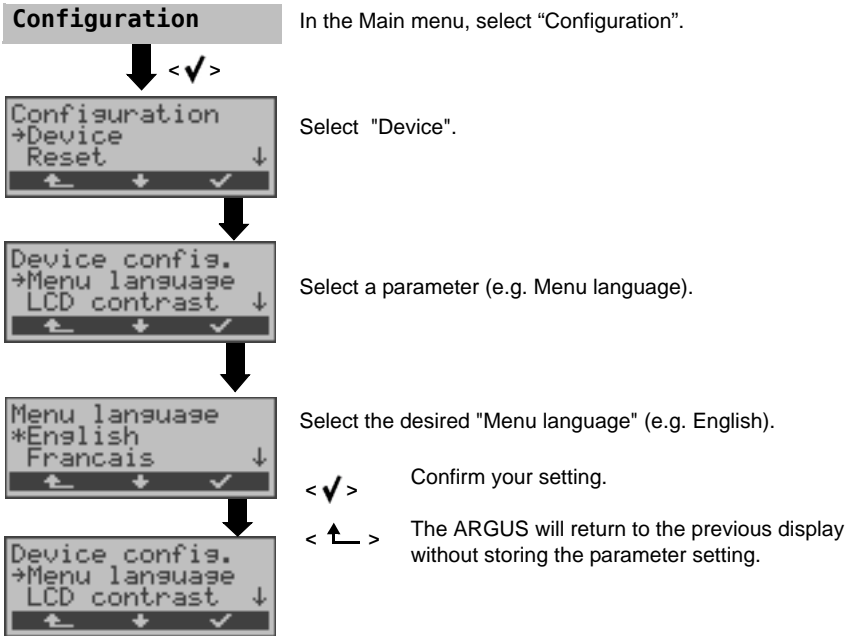

Parameter	Remark
Menu language	Selection of the menu language Default setting: <i>depends on country</i>
LCD contrast	<div style="display: flex; align-items: flex-start;">  <div style="margin-left: 10px;"> <p>Setting the display contrast: The contrast can be adjusted in 16 steps. Use the cursor-keys to adjust the display contrast. The display shows a vertical arrow, which shows the current setting on a scale from low to high contrast.</p> </div> </div>

<p>Date / time</p>	 <p>Enter the date and time. Initialization of the internal clock using the keypad. Use the ↓-key to scroll to the next line. The entered time will be continuously updated by the ARGUS's real time clock as long as the power is not switched off. When the power is switched off (the ARGUS switched off without batteries), the clock will run a few more weeks on its internal supply. If the backup supply is exhausted, the time will be undefined and must be set again.</p>
<p>Baud rate</p>	<p>Sets the maximum Baud rate to be used by the ARGUS to communicate with a PC. Default setting: max 57,600 baud</p>
<p>Alarm bell</p>	<p>The ARGUS signals with an alarm in a variety of situations, e.g. when a bit error occurs in a BERT. When this parameter is set to "off", all audible alarms are suppressed. Default setting: off</p>
<p>Power-management</p>	<p>Set the how long the ARGUS can remain idle before it will switch to power-down mode. If power-down mode is disabled, the ARGUS will display a message, when it is switched on, warning that this will lead to a shorter battery life. The ARGUS can be set to automatically power down after 5, 10, 15 or 30 minutes. Default setting: after 5 minutes</p> <p>Set how long the background lighting will remain on. The background lighting can be set to switch off after 30 sec., 1 minute or 5 minutes. Default setting: off after 30 seconds</p>
<p>Software-option</p>	<p>To enable a software option (e.g. additional functions), you must first enter a software key via the keypad.</p>

9.3 Reset all parameters



The ARGUS will reset all of the parameters to their default values.

The PPP user name, PPP password, IP addresses, Profile names and all of the test results stored in the ARGUS (e.g. ADSL test results etc.) will be deleted.

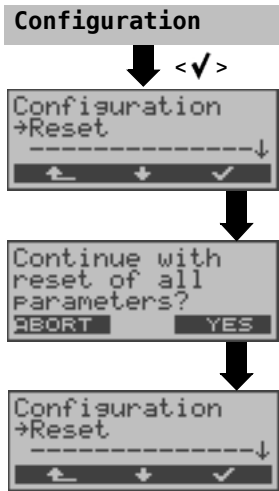



In the Main menu, select "Configuration".

Select "Reset".

Security query

Reset ARGUS to its default values

Alternative: Then press one after the other the keys  and . The ARGUS will first prompt you to confirm that you really want to do this (see above).

The default values can be found in the relevant chapter.

10 Use of accumulators and battery packs

Replacing the accumulators

Switch the ARGUS off and disconnect the plug-in power supply. Afterwards, remove the complete set of accumulators or replace the battery pack.

Accumulators - Usage



The accumulators used in the ARGUS must have the same capacity and be charged to the same level. To ensure that this is achieved, you must observe the following rules:

Accumulator set

- The supplied accumulators must only be charged and discharged in the ARGUS.
- Do not use the supplied accumulators in other devices.
- Do not use accumulators with differing capacities or ones that are not equally charged.
- Order a complete set of new accumulators from the manufacturer and use these to replace the complete set of old accumulators. After you have replaced a set of accumulators, they must be fully charged in the ARGUS before use.
- The accumulators should not be exposed to very high or low temperatures any longer than necessary.
- Discharge and recharge the accumulators fully at least once a month (even if the ARGUS is not used for a longer period of time).
- When the capacity of the accumulators decreases, replace all of the entire set.
- Do not use batteries.

Automatic recharging of the accumulators when the ARGUS is switched on

The ARGUS automatically recharges the accumulators (often shortened to "accus"), if the ARGUS is connected to the plug-in power supply and is switched off and the battery pack voltage is too low. While charging, the ARGUS displays the message "Charge accu". If you press and hold the power switch, the ARGUS will switch off before the accumulators are recharged. Once the accumulators are charged, the ARGUS display "Done" and - if no errors occurred while charging - will automatically switch off.

Charge accus

The ARGUS will display the current charge of the accumulators graphically, if no power supply is connected. In the LCD display, a battery symbol will begin to blink, when there is still approximately (depending on the mode of operation) 5 minutes reserve power. During this period, it is possible that there may be audible interference and in rare cases even malfunctions. Connect the power supply.

When the power supply is connected, the accumulators in the ARGUS can be completely discharged or immediately (without being first discharged) recharged. The discharge procedure takes up to 7 hours. The ARGUS will automatically begin recharging the accumulators after a break of about 30 minutes (depending on the capacity of the accumulators, it can take up to 7 hours to recharge them).

Accu servicing

In the Main menu, select "Accu service".



Charging

Select "Charge accu".



Charging will begin if the plug-in power supply is connected. The ARGUS will display the level of the charge and the voltage while charging the accumulators.

<ABORT> The download is stopped.



Discharging and recharging the accumulators (Accu servicing)

The accumulators will first be fully discharged and then - after a brief pause - automatically recharged.

In the Main menu, select "Accu service". Afterwards select "Discharge & Charge".

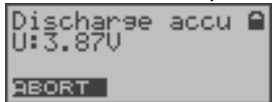

Notes on the use of the battery pack The accumulator service can take up to 16 hours.

Automatic recharging of the battery pack during operation (trickle charge)

"Accu servicing during operation" does not replace "normal" charging, since the ARGUS will only top up the current charge with a trickle charge.

If the ARGUS is disconnected from its power supply, it is possible that the accumulators may not be fully charged. In such case, when the ARGUS is reconnected to the power supply, it will not begin to charge the accumulators again until their voltage drops below the threshold once more.

If the ARGUS is switched off during "Accu servicing during operation", it will switch back to "normal accu charging" (see page 53 Automatic recharging of the accumulators when the ARGUS is switched on).

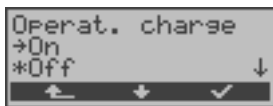
Accu servicing

If the trickle charge setting is set to "ON", the ARGUS will begin charging the accus automatically while it is in operation (if the power supply is plugged in) as soon as the voltage drops below the threshold (display shows battery symbol).

11 Firmware update

You can download a firmware file from www.argus.info/en/service free-of-charge and save it on your PC to later transfer to your ARGUS tester.

Open the Internet site www.argus.info/en:



HOME PRODUCTS **SERVICE** NEWS ABOUT US DEALERS CONTACT

In the "Service" drop-down list that now appears, click on "Downloads".

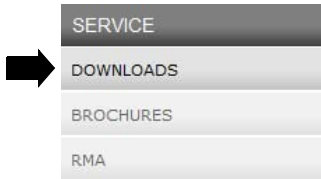

Sie gelangen zur Produktübersicht



Download area

Download user manuals, an overview of menu and test leads, data sheets, brochures, PC software and our free firmware updates.

Choose your Tester:

- | | |
|-----------------------|----------------|
| ARGUS 145 plus | ARGUS 126 |
| ARGUS 142 | ARGUS 145 |
| ARGUS 141 | ARGUS 42 |
| ARGUS 42 plus | ARGUS 41 plus |
| ARGUS 42 basic | ARGUS 44 |
| ARGUS 125 | ARGUS 43 |
| ARGUS 3u NT | ARGUS 28 |
| ARGUS 3u plus | ARGUS 26 |
| ARGUS 3u basic plus | ARGUS 25 |
| | ARGUS 10 |
| WINplus/WINanalyse | ARGUS 3u basic |
| ARGUS Update-Tool | ARGUS 3u |

Select the model of your ARGUS.



ARGUS
testing the telecom network

manufactured by **intec**

PRODUCTS...
INTERFACES...
SEARCH >
DEUTSCH | ENGLISH | ESPAÑOL

HOME PRODUCTS SERVICE NEWS ABOUT US DEALERS CONTACT

ARGUS® 42^{BASIC}
ADSL-Tester

Quick and easy operation: the ARGUS 42 basic ADSL Tester offers a low-cost entry into the world of ADSL measurement technology.

ARGUS 42 BASIC DOWNLOADS / FIRMWARE

OVERVIEW
TECHNICAL DETAILS
DOWNLOADS:
DATASHEET
MANUAL
PC SOFTWARE
FIRMWARE
BACK

ARGUS 42basic Firmware (V 1.12 / German)
011_ARGUS 42basic_Firmware_D_V_1_12.zip (8.83 MB)

ARGUS 42basic Firmware (V 1.12 / English)
021_ARGUS 42basic_Firmware_U_V_1_12.zip (8.82 MB)

ARGUS 42basic Firmware (V 1.12 / French)
031_ARGUS 42basic_Firmware_F_V_1_12.zip (8.82 MB)

ARGUS 42basic Firmware (V 1.12 / Spanish)
041_ARGUS 42basic_Firmware_E_V_1_12.zip (8.82 MB)

Important information regarding the ARGUS firmware update:



Do not, under any circumstances, start to update the firmware if the ARGUS is running on its battery pack. First connect the ARGUS to the plug-in power supply, before sending the firmware update file from your PC to the ARGUS.

The ARGUS USB serial adapter is required in order to perform an update. Save the configuration and test reports before beginning an upgrade.

Do not disconnect the ARGUS from the PC during the update.

Do not switch the ARGUS off while an update is being performed.

You must also pay attention to the messages on the ARGUS display – not just the instructions displayed by the Update Tool on the PC.

The update has not been successfully completed until the Update Tool displays a corresponding message on the PC and the ARGUS – after being automatically restarted by the Update Tool – shows the normal startup screen.

The ARGUS will not switch on until after you have clicked on one of the two buttons ("back to step 1" or "Exit program") on the Update Tool after the update has been completed.